

# ARTESYN PTH03030

3.3 Vin Single Output



Advanced Energy's Artesyn PTH03030 series non-isolated DC-DC converter complies with the Point-of-Load Alliance (POLA) standard. It offers some of the most advanced POL functions in the industry, including Auto-Track™ sequencing for controlled power-up/power-down of complex semiconductor devices such as DSPs, FPGAs and ASICs, and voltage margining. Standard features include pre-bias startup, input undervoltage lockout, remote sense, remote On/Off and auto resetting short-circuit protection. PTH03030 series converters have an input voltage range of 2.95 to 3.65 Vdc and an output voltage that can be trimmed from 0.8 to 2.5 Vdc to meet a wide variety of semiconductor power needs. Rated at 75 watts, the converters offer up to 93% efficiency and can deliver up to 30 amps. Available in through-hole horizontal mount and surface-mount versions, they have a small 1.1 x 1.37 inch (28.4 x 34.8 mm) footprint and an installed height of just 0.35 inch (9 mm).

## SPECIAL FEATURES

- 30 A output current
- 3.3 V input voltage
- Wide-output voltage adjust (0.8 V - 2.5 V)
- Auto-track™ sequencing\*
- Margin up/down controls
- Pre-bias start-up capability
- Efficiencies up to 93%
- Output ON/OFF inhibit
- Output voltage sense
- Point-of-Load-Alliance (POLA) compatible

- RoHS compliant
- Two year warranty

## SAFETY

- UL/cUL CAN/CSA-C22.2 No. 60950-1-03
- UL 60950-1 File No. E174104
- TÜV Product Service (EN60950) Certificate No. B04 06 38572 044
- CB report and certificate to IEC60950, Certificate No. US/8292/UL

## DATA SHEET

### Total Power:

75 Watts

### Input Voltage:

2.95 - 3.65 Vdc

### # of Outputs:

Single



\*Auto-track is a trademark of Texas Instruments.

## ELECTRICAL SPECIFICATIONS

Input		
Input voltage range	(See Note 3)	2.95 - 3.65 V
Input current	No load	10 mA typical
Remote ON/OFF	(See Note 1)	Positive logic
Start-up time		1 V/ms
Undervoltage lockout		2.8 - 2.95 V typical
Track input voltage	Pin 11 (See Note 6, 7)	±0.3 V <sub>in</sub>
Output		
Voltage adjustability	(See Note 4)	0.8 - 2.5 V <sub>dc</sub>
Setpoint accuracy		±2.0% V <sub>o</sub>
Line regulation		±10 mV typical
Load regulation		±12 mV typical
Total regulation		±3.0% V <sub>o</sub>
Minimum load		0 A
Ripple and noise	20 MHz bandwidth	30 mV pk-pk
Temperature co-efficient	-40 °C to +85 °C	±0.5% V <sub>o</sub>
Transient response	(See Note 5)	70 μs recovery time Overshoot/undershoot 100 mV
Margin adjustment		±5.0% V <sub>o</sub>

All specifications are typical at nominal input, full load at 25 °C unless otherwise stated. C<sub>in</sub> = 1500 μF, C<sub>out</sub> = 0 μF.

## GENERAL SPECIFICATIONS

Efficiency	(See Efficiency Table)	93% max.
Insulation voltage		Non-isolated
Switching frequency	Fixed	275 - 325 kHz
Approvals and standards		EN60950, UL/cUL60950
Material flammability		UL94V-0
Dimensions	L x W x H	34.80 x 28.45 x 9.00 mm 1.370 x 1.120 x 0.354 in
Weight		10 g (0.35 oz)
MTBF	Telcordia SR-332	2,821,000 hours

## EMC CHARACTERISTICS

Electrostatic discharge	EN61000-4-2, IEC801-2
Conducted immunity	EN61000-4-6
Radiated immunity	EN61000-4-3

## ENVIRONMENTAL SPECIFICATIONS

Thermal performance (See Note 2)	Operating ambient temperature	-40 °C to +85 °C
	Non-operating temperature	-40 °C to +125 °C
MSL ('Z' suffix only)	JEDEC J-STD-020C	Level 3
Protection		
Short-circuit	Auto reset	45 A typical
Thermal		Yes

## ORDERING INFORMATION

Model Number <sup>®</sup>	Output Power (Max.)	Input Voltage	Output Voltage	Output Current (Min.)	Output Current (Max.)	Efficiency (Typical)	Regulation	
							Line	Load
PTH03030	75 W	2.95 - 3.65 V	0.8 - 2.5 V	0 A	30 A	93%	±10 mV	±12 mV

## PART NUMBER SYSTEM WITH OPTIONS

Product Family	Input Voltage	Output Current	Mechanical Package	Output Voltage Code	Pin Option	Mounting Options	Pin Option
<b>PTH</b>	<b>03</b>	<b>03</b>	<b>0</b>	<b>W</b>	<b>A</b>	<b>S</b>	<b>T</b>
Point-of-Load Alliance compatible	03 = 3.3 V	03 = 30 A	Always 0	W = Wide		D = Horizontal through-hole (Matte Sn)  Z = Surface-mount (96.5/3.0/0.5 Sn/Ag/Cu pin solder material)	No Suffix = Trays T = Tape and Reel <sup>®</sup>

## OUTPUT VOLTAGE ADJUSTMENT

The ultra-wide output voltage trim range offers major advantages to users who select the PTH03030. It is no longer necessary to purchase a variety of modules in order to cover different output voltages. The output voltage can be trimmed in a range of 0.8 Vdc to 2.5 Vdc. When the PTH03030 converter leaves the factory the output has been adjusted to the default voltage of 0.8 V.

Efficiency Table (Io = 20A)	
Output Voltage	Efficiency
Vo = 1.0 V	85%
Vo = 1.2 V	87%
Vo = 1.5 V	89%
Vo = 1.8 V	91%
Vo = 2.0 V	92%
Vo = 2.5 V	93%

**Notes:**

- Remote ON/OFF, Positive Logic  
 ON: Pin 3 open; or  $V > V_{in} - 0.5 V$   
 OFF: Pin 3 GND; or  $V < 0.8 V$  (min - 0.2 V).
- See Figures 1 for safe operating curves.
- A 1500  $\mu F$  electrolytic input capacitor is required for proper operation. The capacitor must be rated for a minimum of 900 mA rms of ripple current.
- An external output capacitor is not required for basic operation. Adding 330  $\mu F$  of distributed capacitance at the load will improve the transient response.
- 1 A/ $\mu s$  load step, 50 to 100% I<sub>o max</sub>, C<sub>out</sub> = 330  $\mu F$ .
- If utilized V<sub>out</sub> will track applied voltage by  $\pm 0.3 V$  (up to V<sub>o</sub> set point).
- The pre-bias start-up feature is not compatible with Auto-Track™. This is because when the module is under Auto-Track™ control, it is fully active and will sink current if the output voltage is below that of a back-feeding source. Therefore to ensure a pre-bias hold-off, one of the following two techniques must be followed when input power is first applied to the module. The Auto-Track™ function must either be disabled, or the module's output held off using the Inhibit pin. Refer to Application Note 152 for more details.
- Tape and reel packaging only available on the surface-mount versions.
- NOTICE: Some models do not support all options. Please contact your local Artesyn representative or use the on-line model number search tool at <http://www.artesyn.com> to find a suitable alternative.

OUTPUT VOLTAGE ADJUSTMENT (CONTINUED)

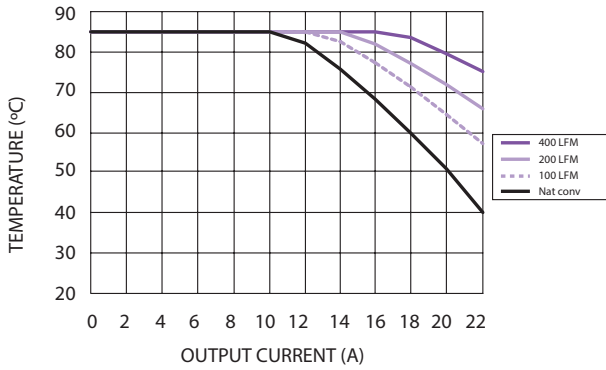

Figure 1 - Safe Operating Area  
 Vin = 3.3 V, Output Voltage = 2.5 V (See Note A)

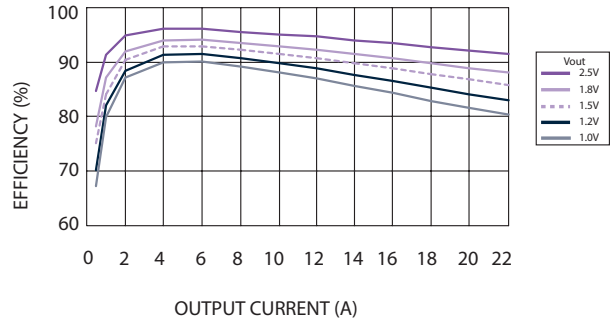

Figure 2 - Efficiency vs Load Current  
 Vin = 3.3 V (See Note B)

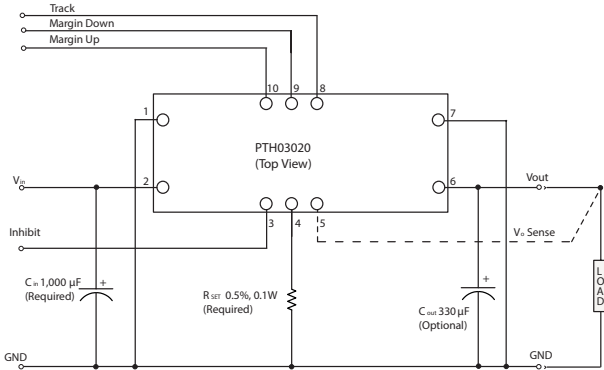

Figure 3 - Standard Application

Notes:

- A. SOA curves represent the conditions at which internal components are within the Artesyn derating guidelines.
- B. Characteristic data has been developed from actual products tested at 25 °C. This data is considered typical data for the converter.

MECHANICAL DRAWINGS

Plated through-hole

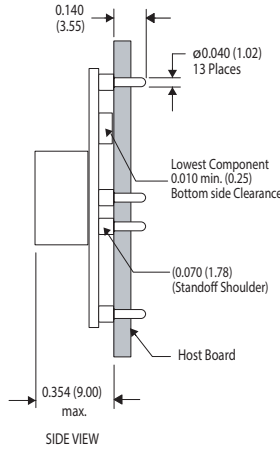
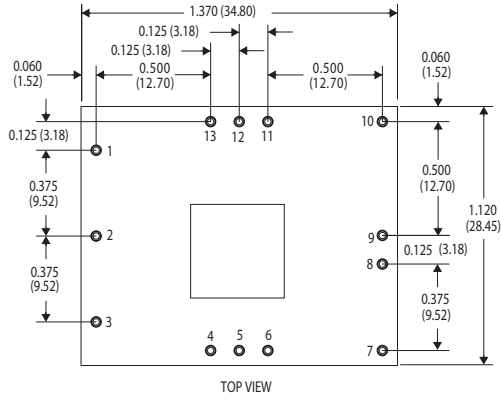

Dimensions in Inches (mm)  
Tolerances (unless otherwise specified)  
2 Places  $\pm 0.030$  (  $\pm 0.76$  )  
3 Places  $\pm 0.010$  (  $\pm 0.25$  )

Surface-mount

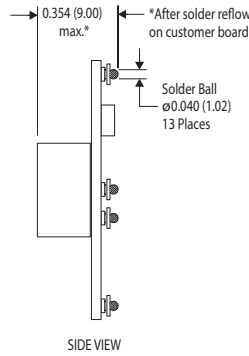
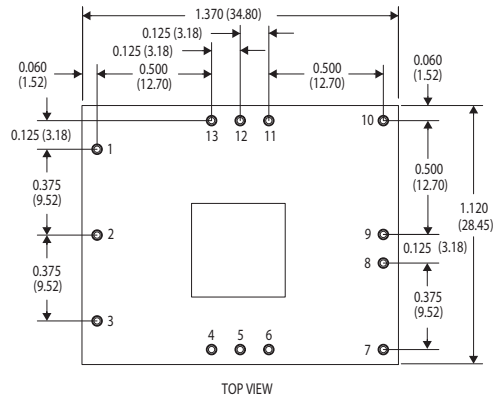

Dimensions in Inches (mm)  
Tolerances (unless otherwise specified)  
2 Places  $\pm 0.030$  (  $\pm 0.76$  )  
3 Places  $\pm 0.010$  (  $\pm 0.25$  )

Pin Assignments	
Pin	Function
1	Ground
2	Vin
3	Ground
4	Inhibit*
5	Vo adjust
6	Vo sense
7	Ground
8	Vout
9	Vout
10	Ground
11	Track
12	Margin down*
13	Margin up*

\*Denotes negative logic:  
Open = Normal operation  
Ground = Function active



For international contact information,  
visit [advancedenergy.com](http://advancedenergy.com).

[powersales@aei.com](mailto:powersales@aei.com) (Sales Support)  
[productsupport.ep@aei.com](mailto:productsupport.ep@aei.com) (Technical Support)  
+1 888 412 7832

## ABOUT ADVANCED ENERGY

Advanced Energy (AE) has devoted more than three decades to perfecting power for its global customers. AE designs and manufactures highly engineered, precision power conversion, measurement and control solutions for mission-critical applications and processes.

Our products enable customer innovation in complex applications for a wide range of industries including semiconductor equipment, industrial, manufacturing, telecommunications, data center computing, and medical. With deep applications know-how and responsive service and support across the globe, we build collaborative partnerships to meet rapid technological developments, propel growth for our customers, and innovate the future of power.

PRECISION | POWER | PERFORMANCE

---

Specifications are subject to change without notice. Not responsible for errors or omissions. ©2021 Advanced Energy Industries, Inc. All rights reserved. Advanced Energy®, AE® and Artesyn™ are U.S. trademarks of Advanced Energy Industries, Inc.