

ARTESYN ERM 75W SERIES

DC/DC Converter



PRODUCT DESCRIPTION

Advanced Energy's Artesyn ERM75 series is a new generation of high performance, isolated dc-dc converter modules. The product offers 75W in a small, fully encapsulated package. The input voltage ranges comply with European railway standard EN50155. Reinforced insulation and high EMC immunity qualifies these converters also for many demanding applications in railway and other transportation systems.

Advanced circuit topology provides a very high efficiency up to 92% which allows ambient temperatures range up to +85 °C with derating.

AT A GLANCE

Total Power

75 Watts

Input Voltage

72 or 110 Vdc

of Outputs

Single

SPECIAL FEATURES

- Small 57.9 x 36.8 x12.7 mm package
- Input Ranges 43-101 Vdc or 66-160 Vdc
- High Efficiency up to 92%
- No Minimum Load Requirement
- Operating Temp. Range -40 °C to +85 °C
- Reinforced Insulation 3000 VACrms
- Under-Voltage Shutdown
- Remote On/Off
- Metal Case with Isolated Baseplate
- EN60950-1 Safety Standard
- EN50155 (IEC60571)/EN50121-3-2 and EN45545-2 Railway Standard
- EN45545-2 Flammability
- 3 Years Warranty

SAFETY

- cUL/UL 60950-1
- IEC/EN 60950-1
- IEC/EN 50155

TYPICAL APPLICATIONS

- Railway



MODEL NUMBERS

Model	Input Voltage Range	Output Voltage	Minimum Load	Maximum Load
ERM15A72	72 (43 - 101) Vdc	5 Vdc	0A	15A
ERM06B72	72 (43 - 101) Vdc	12 Vdc	0A	6.25A
ERM05C72	72 (43 - 101) Vdc	15 Vdc	0A	5A
ERM03H72	72 (43 - 101) Vdc	24 Vdc	0A	3.125A
ERM15A110	110 (66 - 160) Vdc	5 Vdc	0A	15A
ERM06B110	110 (66 - 160) Vdc	12 Vdc	0A	6.25A
ERM05C110	110 (66 - 160) Vdc	15 Vdc	0A	5A
ERM03H110	110 (66 - 160) Vdc	24 Vdc	0A	3.125A

Note - All DC/DC converters should be externally fused at the front end for protection.

Options

Heatsink (-HS)

ELECTRICAL SPECIFICATIONS

Absolute Maximum Ratings

Stress in excess of those listed in the “Absolute Maximum Ratings” may cause permanent damage to the power supply. These are stress ratings only and functional operation of the unit is not implied at these or any other conditions above those given in the operational sections of this TRN. Exposure to any absolute maximum rated condition for extended periods may adversely affect the power supply’s reliability.

Table 1. Absolute Maximum Ratings						
Parameter	Model	Symbol	Min	Typ	Max	Unit
Input Voltage: (DC continuous operation)	ERM15A72	$V_{IN,DC}$	43	-	101	Vdc
	ERM06B72		43	-	101	
	ERM05C72		43	-	101	
	ERM03H72		43	-	101	
	ERM15A110		66	-	160	
	ERM06B110		66	-	160	
	ERM05C110		66	-	160	
	ERM03H110		66	-	160	
Maximum Output Power	All models	$P_{O,max}$	-	-	75	W
Isolation Resistance 500Vdc	All models		1000	-	-	Mohm
I/O Isolation Capacitance 100KHz, 1V	All models		-	-	3000	pF
Isolation Voltage	Input to output	All models	3000	-	-	Vacrms
	Input to case	All models	1500	-	-	Vdc
	Output to case	All models	1500	-	-	Vdc
Operating Ambient Temperature (With derating, refer to derating curve)	ERM06B72 ERM05C72 ERM03H72 ERM06B110 ERM05C110 ERM03H110 ERM15A72 ERM15A110	T_A	-40	-	+85	°C
Operating Base-plate Temperature Range	All models		-40	-	+105	°C
Storage Temperature	All models	T_{STG}	-50	-	+125	°C
Fire protection test	Compliance to EN45545-2					
Humidity (non-condensing)	All models		5	-	95	%

ELECTRICAL SPECIFICATIONS

Input Specifications

Table 2. Input Specifications							
Parameter		Condition	Symbol	Min	Typ	Max	Unit
Operating Input Voltage, DC	ERM15A72	All	$V_{IN,DC}$	43	72	101	Vdc
	ERM06B72			43	72	101	
	ERM05C72			43	72	101	
	ERM03H72			43	72	101	
	ERM15A110			66	110	160	
	ERM06B110			66	110	160	
	ERM05C110			66	110	160	
	ERM03H110			66	110	160	
Start-up Threshold Voltage	ERM10A72	All	$V_{IN,ON}$	-	-	43	Vdc
	ERM04B72			-	-	43	
	ERM03C72			-	-	43	
	ERM02H72			-	-	43	
	ERM10A110			-	-	66	
	ERM04B110			-	-	66	
	ERM03C110			-	-	66	
	ERM02H110			-	-	66	
Under Voltage Lockout	ERM15A72	All	$V_{IN,OFF}$	-	40	-	Vdc
	ERM06B72			-	40	-	
	ERM05C72			-	40	-	
	ERM03H72			-	40	-	
	ERM15A110			-	63	-	
	ERM06B110			-	63	-	
	ERM05C110			-	63	-	
	ERM03H110			-	63	-	
Input Surge Voltage	ERM15A72	100ms. Max (with 220uF/200V capacitor)	$I_{IN,surge}$	-0.7	-	165	Vdc
	ERM06B72			-0.7	-	165	
	ERM05C72			-0.7	-	165	
	ERM03H72			-0.7	-	165	
	ERM15A110			-0.7	-	250	
	ERM06B110			-0.7	-	250	
	ERM05C110			-0.7	-	250	
	ERM03H110			-0.7	-	250	
Maximum Input Current	ERM15A72	Maximum value at Vin= Vin nom; Full Load	$I_{IN,max}$	-	1.17	-	A
	ERM06B72			-	1.132	-	
	ERM05C72			-	1.132	-	
	ERM03H72			-	1.145	-	
	ERM15A110			-	0.766	-	
	ERM06B110			-	0.749	-	
	ERM05C110			-	0.749	-	
	ERM03H110			-	0.758	-	

ELECTRICAL SPECIFICATIONS

Input Specifications

Table 2. Input Specifications con't							
Parameter		Condition	Symbol	Min	Typ	Max	Unit
No Load Input Current	ERM10A72	Typical value at $V_{in} = V_{in\ nom}$; No Load	I_{IN,no_load}	-	50	-	mA
	ERM04B72			-	45	-	
	ERM03C72			-	45	-	
	ERM02H72			-	50	-	
	ERM10A110			-	40	-	
	ERM04B110			-	35	-	
	ERM03C110			-	35	-	
ERM02H110	-	40	-				
Efficiency @Max. Load	ERM10A72	$V_{in} = V_{in\ nom}$; Full Load; $T_A = 25\ ^\circ C$	η	-	90	-	%
	ERM04B72			-	92	-	
	ERM03C72			-	92	-	
	ERM02H72			-	91	-	
	ERM10A110			-	90	-	
	ERM04B110			-	91	-	
	ERM03C110			-	92	-	
ERM02H110	-	91	-				
Input Reflected Ripple Current		0 to 500KHz, 4.7 μ H source impedance		-	35	-	mApk-pk
Start Up Time				-	0.35	-	S
Internal Filter Type			Pi Filter				

ELECTRICAL SPECIFICATIONS

Output Specifications

Table 3. Output Specifications							
Parameter		Condition	Symbol	Min	Nom	Max	Unit
Output Voltage Set-Point	ERM15A72	Vin=Vin nom; Full Load; TA=25°C	V _O	4.95	5	5.05	Vdc
	ERM06B72			11.88	12	12.12	
	ERM05C72			14.85	15	15.15	
	ERM03H72			23.76	24	24.24	
	ERM15A110			4.95	5	5.05	
	ERM06B110			11.88	12	12.12	
	ERM05C110			14.85	15	15.15	
	ERM03H110			23.76	24	24.24	
Convection Output Current, continuous	ERM15A72	Convection cooling	I _O	-	-	15	A
	ERM06B72			-	-	6.25	
	ERM05C72			-	-	5	
	ERM03H72			-	-	3.125	
	ERM15A110			-	-	15	
	ERM06B110			-	-	6.25	
	ERM05C110			-	-	5	
	ERM03H110			-	-	3.125	
Max. Output Capacitance Load	ERM15A72	Start up	C	-	-	17000	uF
	ERM06B72			-	-	2950	
	ERM05C72			-	-	1900	
	ERM03H72			-	-	740	
	ERM15A110			-	-	17000	
	ERM06B110			-	-	2950	
	ERM05C110			-	-	1900	
	ERM03H110			-	-	740	
Output Ripple, pk-pk	ERM15A72 ERM06B72 ERM05C72 ERM15A110 ERM06B110 ERM05C110	20MHz bandwidth, Refer to the output specifications or add 4.7uF capacitor if the output specifications undefine Cout.	V _O	-	-	100	mVp-p
	ERM03H72 ERM03H110		V _O	-	-	150	mVp-p
Load Transient Response	Peak Deviation Settling Time	Measured to within 1% error band 25% Load Step Change	- T _s	- -	±3. 250	±5 -	% uSec
Line Regulation		Vin=Min. to Max. @ Full Load		-	-	±0.2	%V _O
Load Regulation		Min. Load to Full Load		-	-	±0.3	%V _O
Output Voltage Adjustment Range			V _O	-10	-	+10	%V _O
Temperature Coefficient		All models		-	-	±0.02	%/ °C
Switching Frequency		All models	f _{sw}	-	320	-	KHz

ELECTRICAL SPECIFICATIONS

ERM15A72 Performance Curves

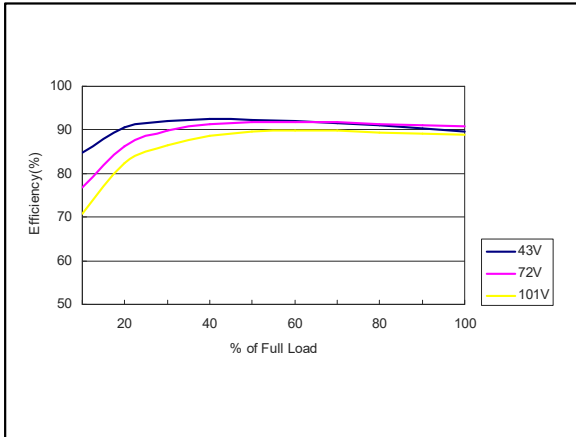

Figure 1: ERM15A72 Efficiency Versus Output Current Curve
 Vin = 43 to 101Vdc Load: Io = 0 to 15A

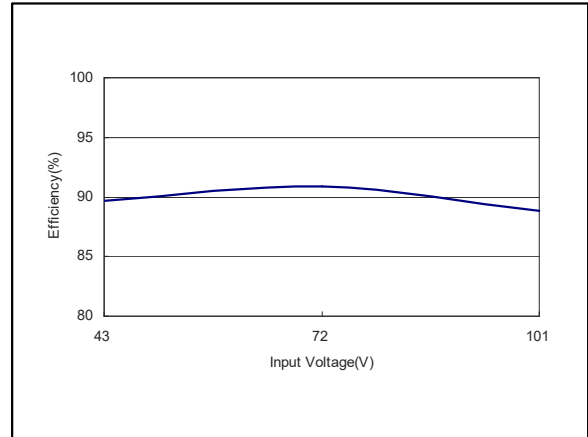

Figure 2: ERM15A72 Efficiency Versus Input Voltage Curve
 Vin = 43 to 101Vdc Load: Io = 0 to 15A

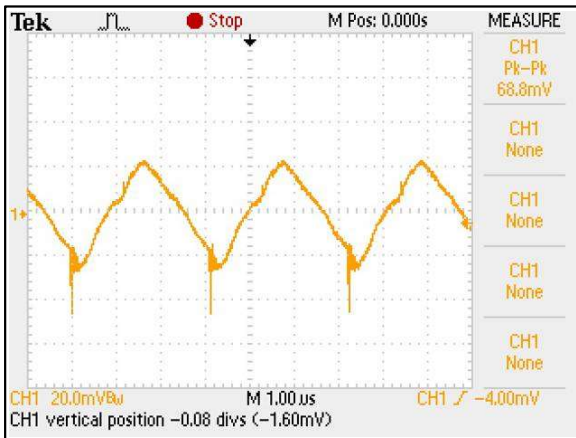

Figure 3: ERM15A72 Typical Output Ripple and Noise.
 Vin = 72Vdc Load: Io = 15A
 Ch 1: Vo

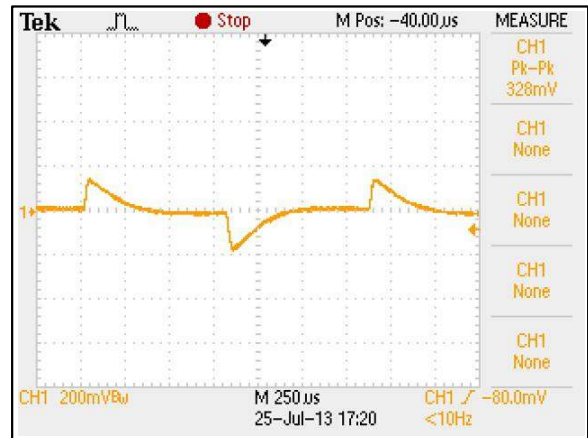

Figure 4: ERM15A72 Transient Response
 Vin = 72Vdc Load: Io = 100% to 75% load change
 Ch 1: Vo

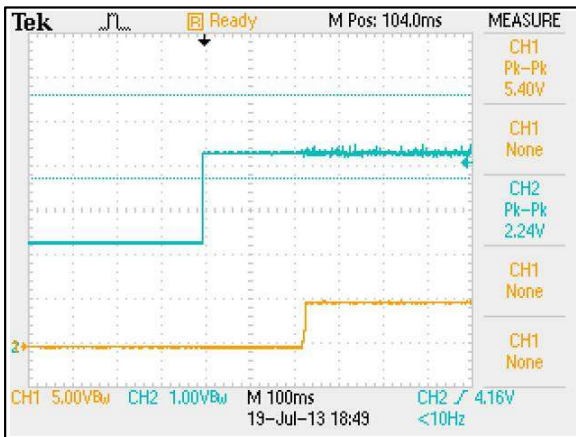

Figure 5: ERM15A72 Output Voltage Startup Characteristic by On/Off
 Vin = 72Vdc Load: Io = 15A
 Ch 1: Vo Ch 2: Remote On/Off

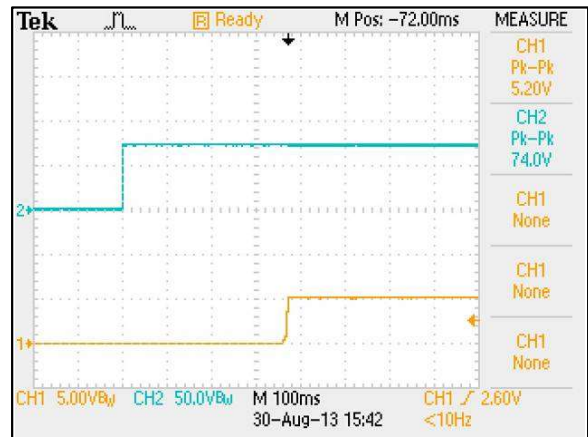

Figure 6: ERM15A72 Output Voltage Startup Characteristic by Vin
 Vin = 72Vdc Load: Io = 15A
 Ch 1: Vo Ch 2: Vin

ELECTRICAL SPECIFICATIONS

ERM15A72 Performance Curves

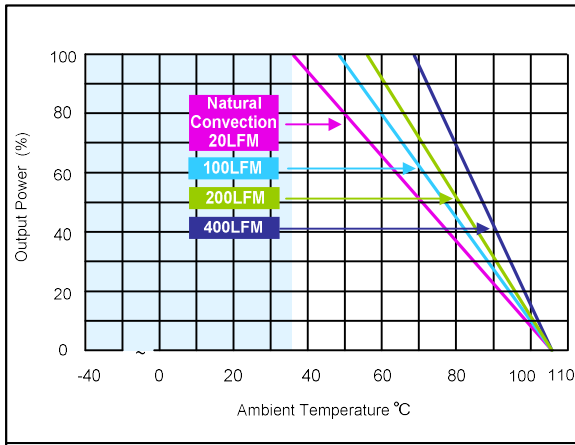

Figure 7: ERM15A72 Derating Curve without Heatsink
 Vin = 72Vdc Load: Io = 0 to 15A

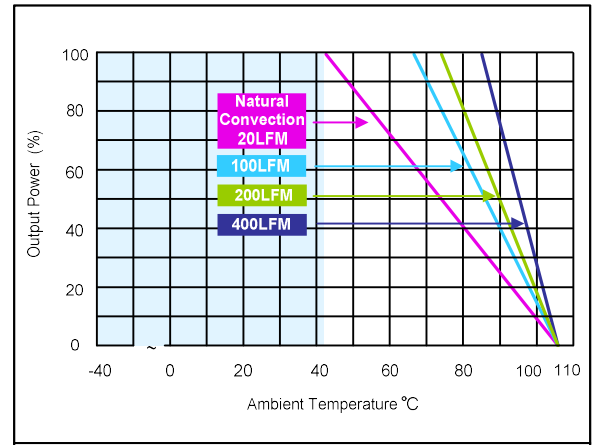

Figure 8: ERM15A72 Derating Curve with Heatsink
 Vin = 72Vdc Load: Io = 0 to 15A

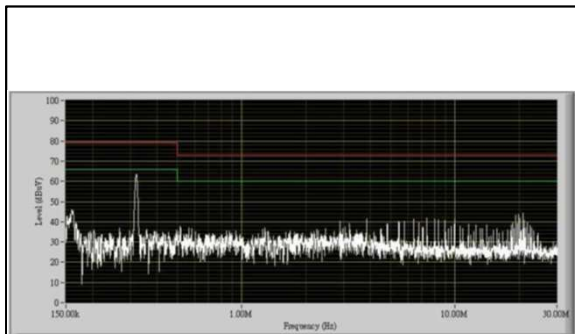

Figure 9: ERM15A72 Conduction Emission of EN55011 Class A
 Vin = 72Vdc Load: Io = 15A

Note - All test conditions are at 25 °C

ELECTRICAL SPECIFICATIONS

ERM06B72 Performance Curves

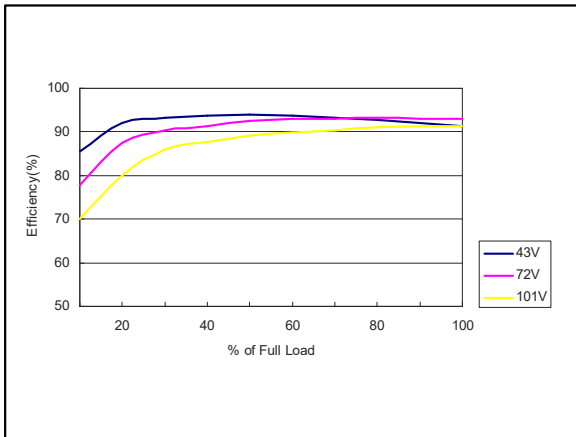

Figure 10: ERM06B72 Efficiency Versus Output Current Curve
 Vin = 43 to 101Vdc Load: Io = 0 to 6.25A

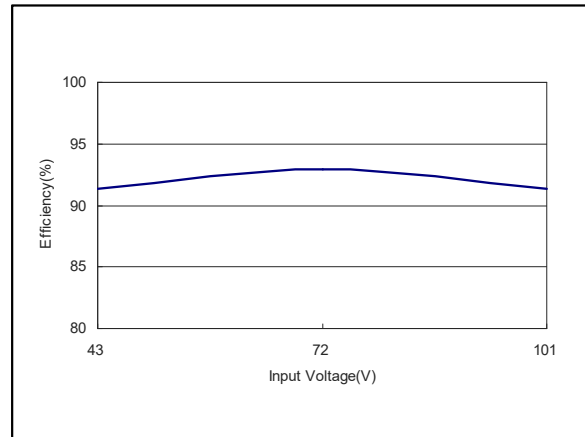

Figure 11: ERM06B72 Efficiency Versus Input Voltage Curve
 Vin = 43 to 101Vdc Load: Io = 0 to 6.25A



Figure 12: ERM06B72 Typical Output Ripple and Noise.
 Vin = 72Vdc Load: Io = 6.25A
 Ch 1: Vo

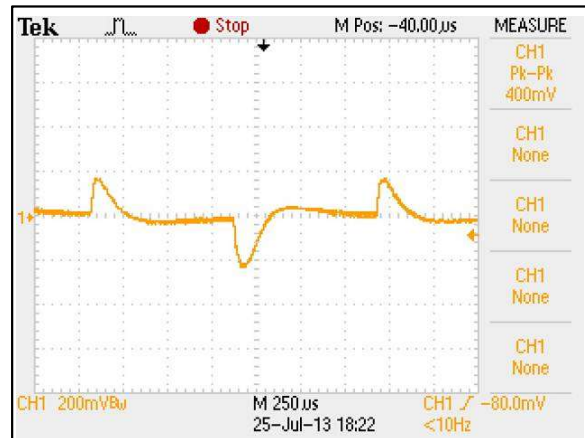

Figure 13: ERM06B72 Transient Response
 Vin = 72Vdc Load: Io = 100% to 75% load change
 Ch 1: Vo

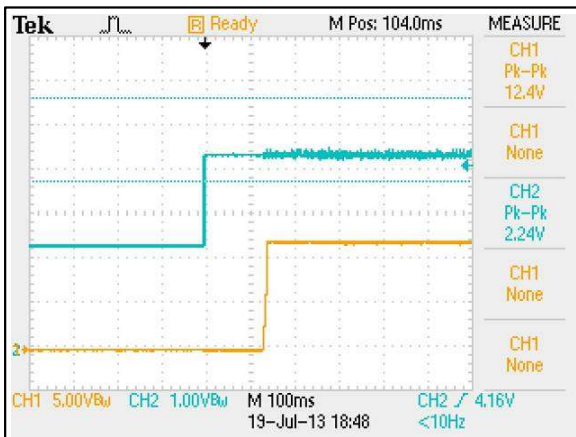

Figure 14: ERM06B72 Output Voltage Startup Characteristic by On/Off
 Vin = 72Vdc Load: Io = 6.25A
 Ch 1: Vo Ch 2: Remote On/Off

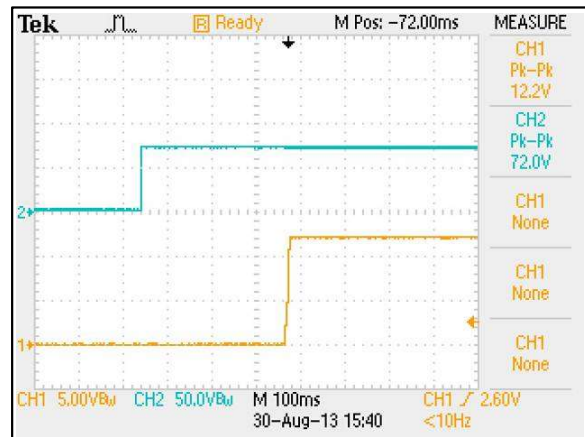

Figure 15: ERM06B72 Output Voltage Startup Characteristic by Vin
 Vin = 72Vdc Load: Io = 6.25A
 Ch 1: Vo Ch 2: Vin

ELECTRICAL SPECIFICATIONS

ERM06B72 Performance Curves

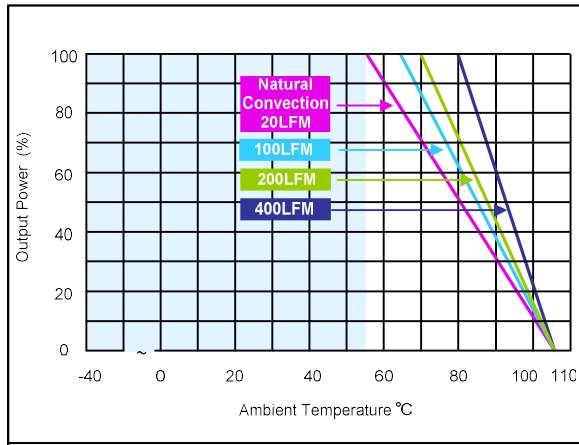

Figure 16: ERM06B72 Derating Curve without Heatsink
 Vin = 72Vdc Load: Io = 0 to 6.25A

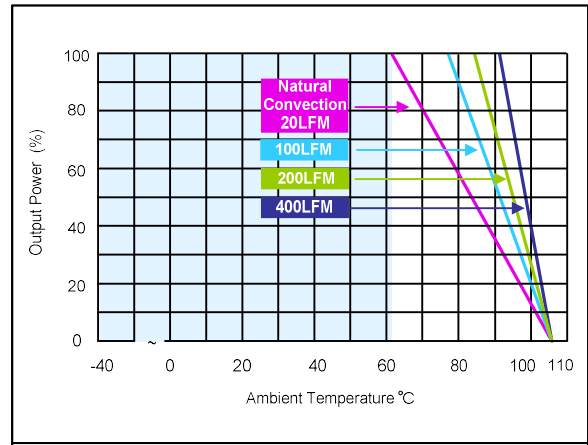

Figure 17: ERM06B72 Derating Curve with Heatsink
 Vin = 72Vdc Load: Io = 0 to 6.25A

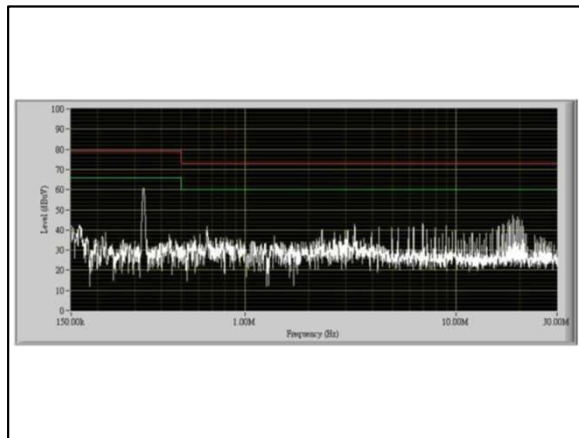

Figure 18: ERM06B72 Conduction Emission of EN55011 Class A
 Vin = 72Vdc Load: Io = 6.25A

Note - All test conditions are at 25 °C

ELECTRICAL SPECIFICATIONS

ERM05C72 Performance Curves

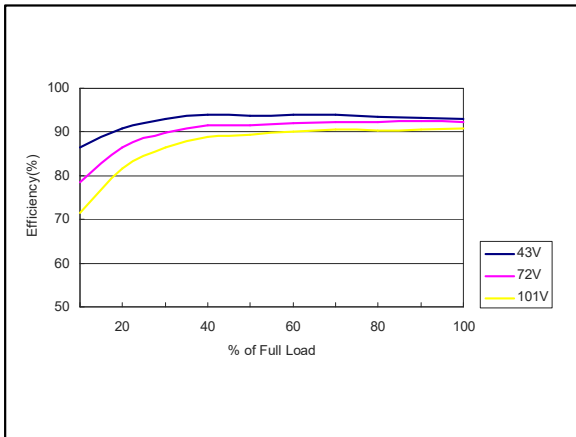

Figure 19: ERM05C72 Efficiency Versus Output Current Curve
 Vin = 43 to 101Vdc Load: Io = 0 to 5A

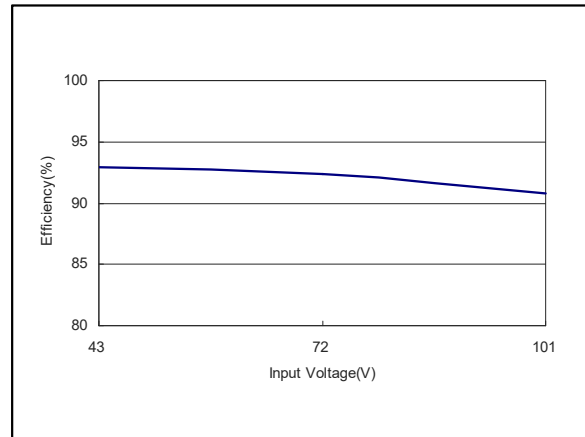

Figure 20: ERM05C72 Efficiency Versus Input Voltage Curve
 Vin = 43 to 101Vdc Load: Io = 0 to 5A

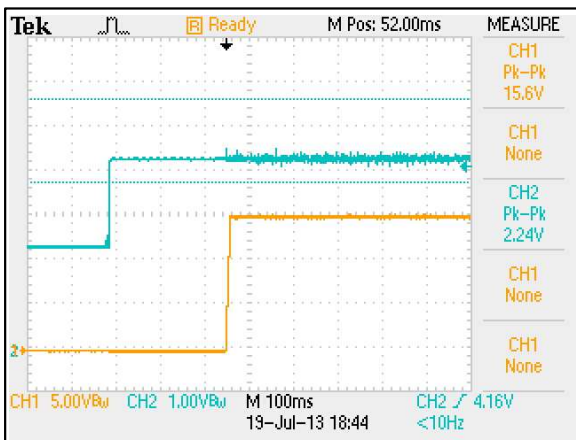

Figure 21: ERM05C72 Typical Output Ripple and Noise.
 Vin = 72Vdc Load: Io = 5A
 Ch 1: Vo

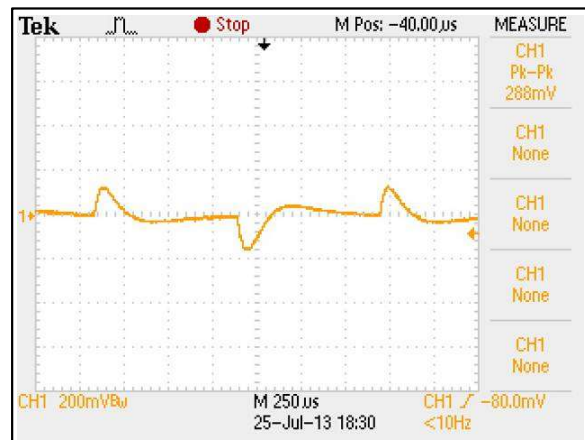

Figure 22: ERM05C72 Transient Response
 Vin = 72Vdc Load: Io = 100% to 75% load change
 Ch 1: Vo

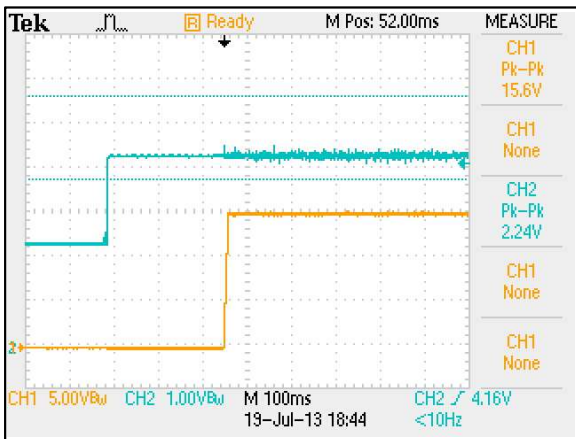

Figure 23: ERM05C72 Output Voltage Startup Characteristic by On/Off
 Vin = 72Vdc Load: Io = 5A
 Ch 1: Vo Ch 2: Remote On/Off

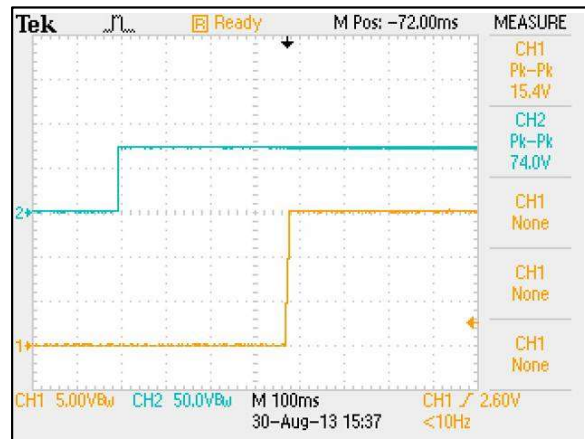

Figure 24: ERM05C72 Output Voltage Startup Characteristic by Vin
 Vin = 72Vdc Load: Io = 5A
 Ch 1: Vo Ch 2: Vin

ELECTRICAL SPECIFICATIONS

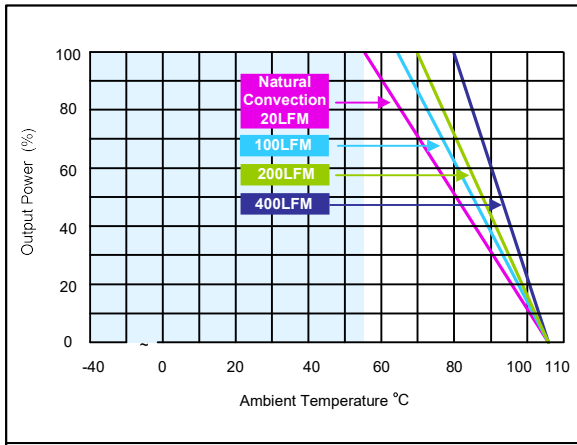

Figure 25: ERM05C72 Derating Curve without Heatsink
 Vin = 72Vdc Load: Io = 0 to 5A

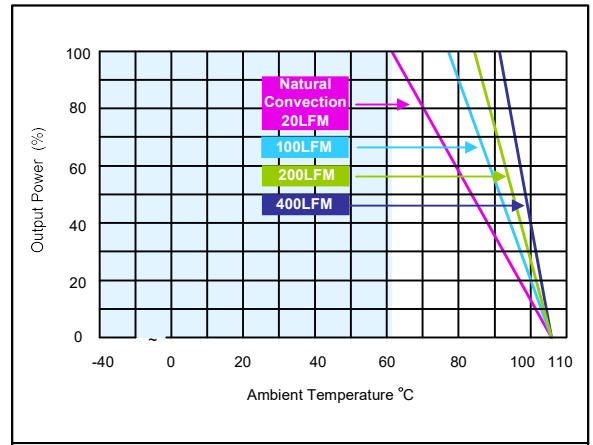

Figure 26: ERM05C72 Derating Curve with Heatsink
 Vin = 72Vdc Load: Io = 0 to 5A

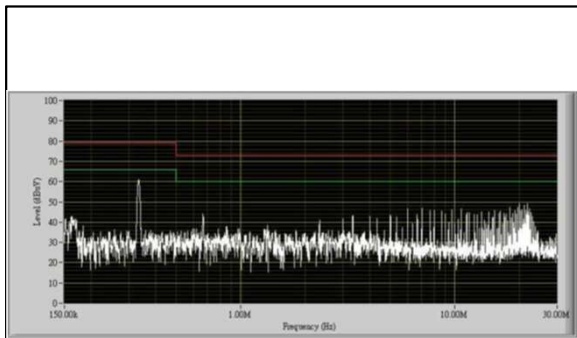

Figure 27: ERM05C72 Conduction Emission of EN55011 Class A
 Vin = 72Vdc Load: Io = 5A

ELECTRICAL SPECIFICATIONS

ERM03H72 Performance Curves

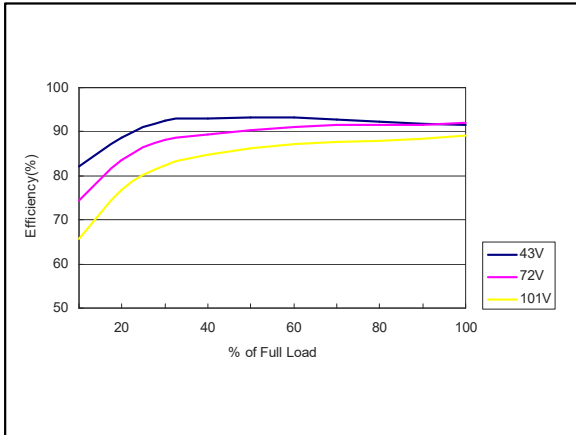

Figure 28: ERM03H72 Efficiency Versus Output Current Curve
 Vin = 43 to 101Vdc Load: Io = 0 to 3.125A

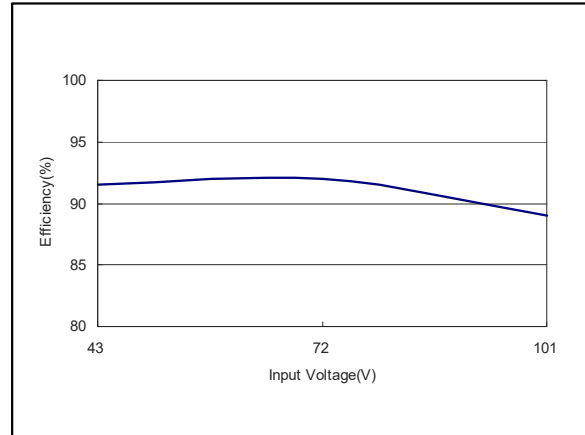

Figure 29: ERM03H72 Efficiency Versus Input Voltage Curve
 Vin = 43 to 101Vdc Load: Io = 0 to 3.125A



Figure 30: ERM03H72 Typical Output Ripple and Noise.
 Vin = 72Vdc Load: Io = 3.125A
 Ch 1: Vo

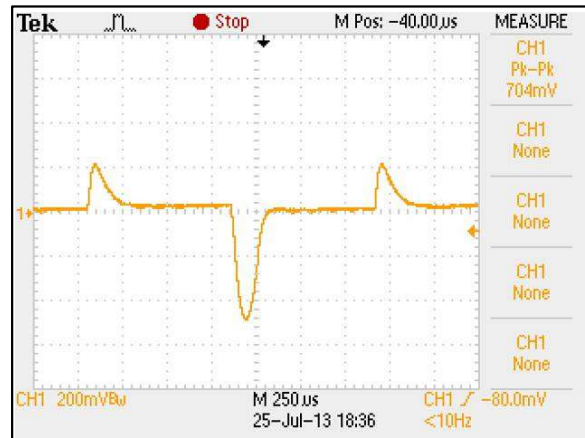

Figure 31: ERM03H72 Transient Response
 Vin = 72Vdc Load: Io = 100% to 75% load change
 Ch 1: Vo

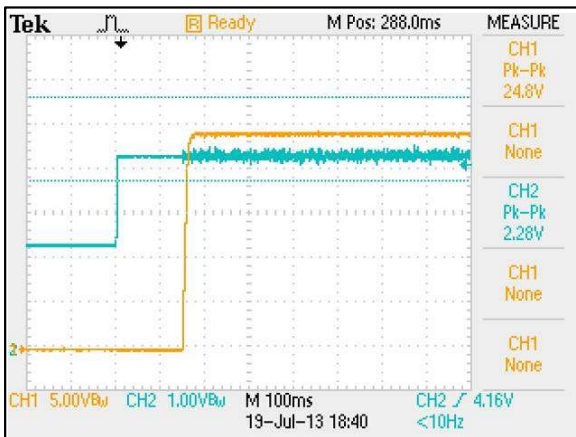

Figure 32: ERM03H72 Output Voltage Startup Characteristic by On/Off
 Vin = 72Vdc Load: Io = 3.125A
 Ch 1: Vo Ch 2: Remote On/Off

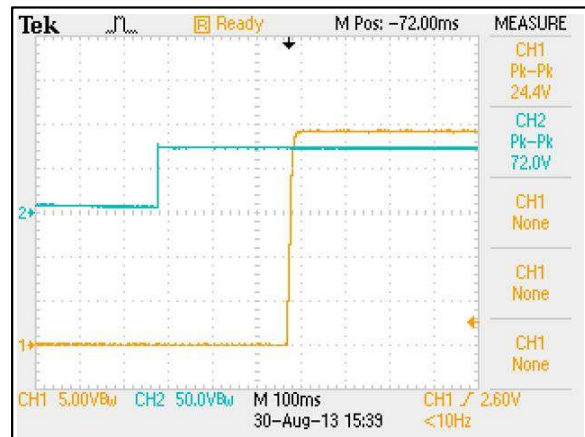

Figure 33: ERM03H72 Output Voltage Startup Characteristic by Vin
 Vin = 72Vdc Load: Io = 3.125A
 Ch 1: Vo Ch 2: Vin

ELECTRICAL SPECIFICATIONS

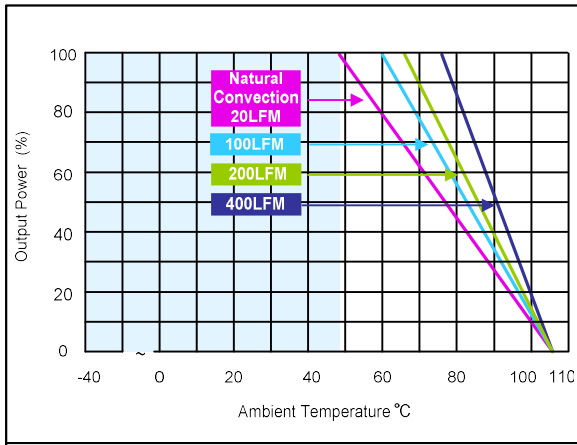

Figure 34: ERM03H72 Derating Curve without Heatsink
 Vin = 72Vdc Load: Io = 0 to 3.125A

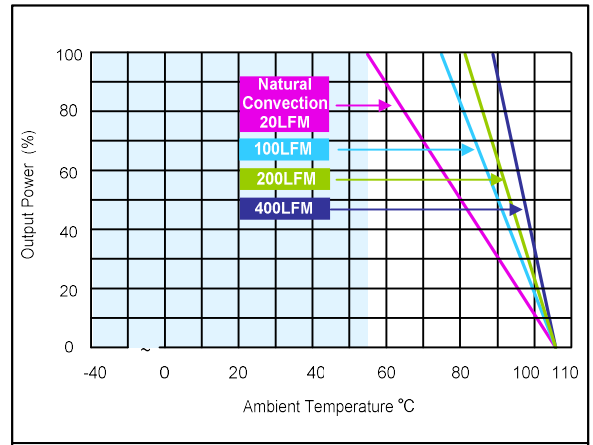

Figure 35: ERM03H72 Derating Curve with Heatsink
 Vin = 72Vdc Load: Io = 0 to 3.125A

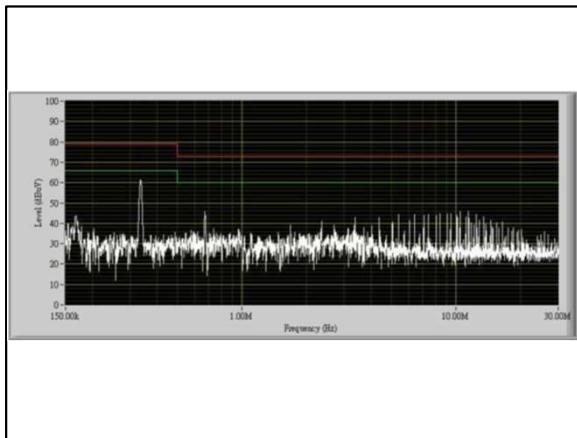

Figure 36: ERM03H72 Conduction Emission of EN55011 Class A
 Vin = 72Vdc Load: Io = 3.125A

ELECTRICAL SPECIFICATIONS

ERM15A110 Performance Curves

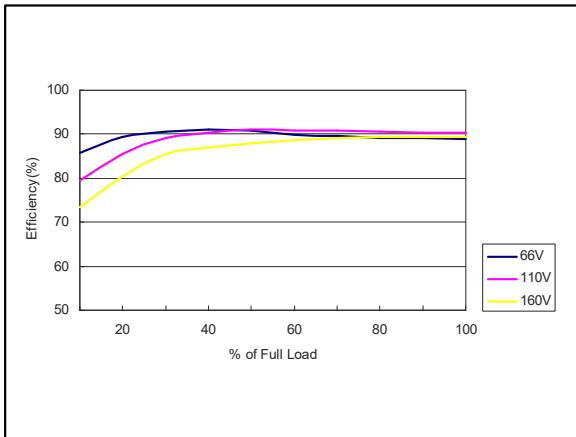

Figure 37: ERM15A110 Efficiency Versus Output Current Curve
 Vin = 66 to 160Vdc Load: Io = 0 to 15A

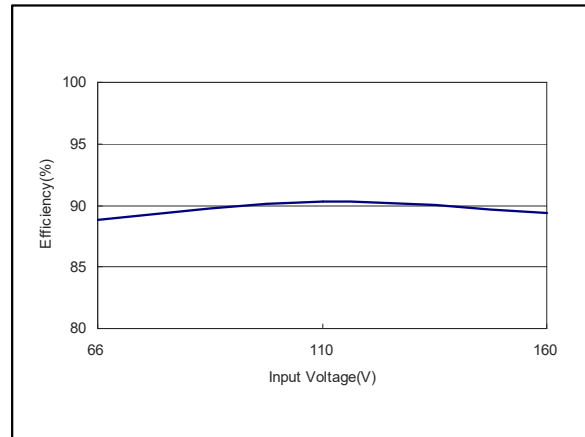

Figure 38: ERM15A110 Efficiency Versus Input Voltage Curve
 Vin = 66 to 160Vdc Load: Io = 0 to 15A

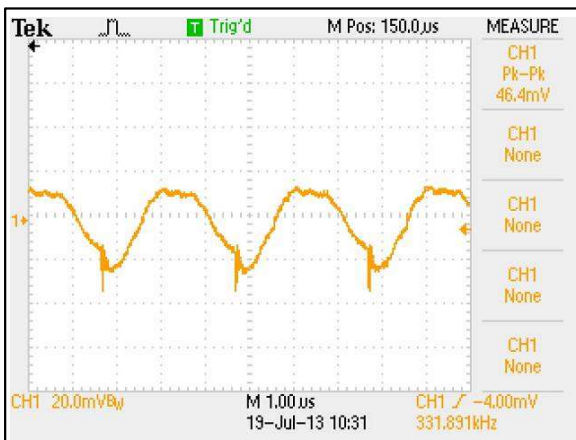

Figure 39: ERM15A110 Typical Output Ripple and Noise.
 Vin = 110Vdc Load: Io = 15A
 Ch 1: Vo

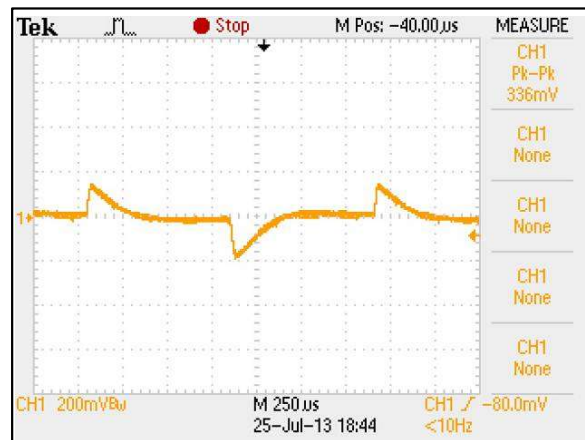

Figure 40: ERM15A110 Transient Response
 Vin = 110Vdc Load: Io = 100% to 75% load change
 Ch 1: Vo

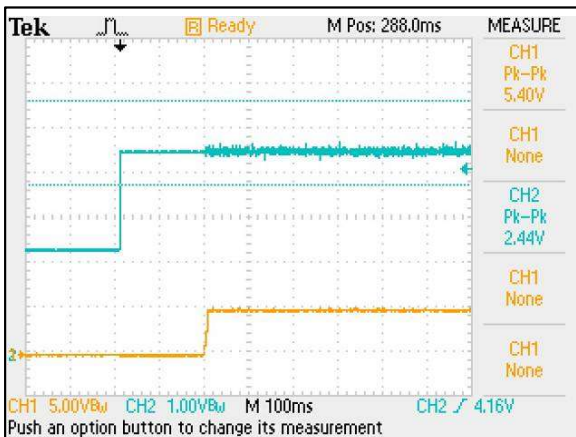

Figure 41: ERM15A110 Output Voltage Startup Characteristic by On/Off
 Vin = 110Vdc Load: Io = 15A
 Ch 1: Vo Ch 2: Remote On/Off



Figure 42: ERM15A110 Output Voltage Startup Characteristic by Vin
 Vin = 110Vdc Load: Io = 15A
 Ch 1: Vo Ch 2: Vin

ELECTRICAL SPECIFICATIONS

ERM15A110 Performance Curves

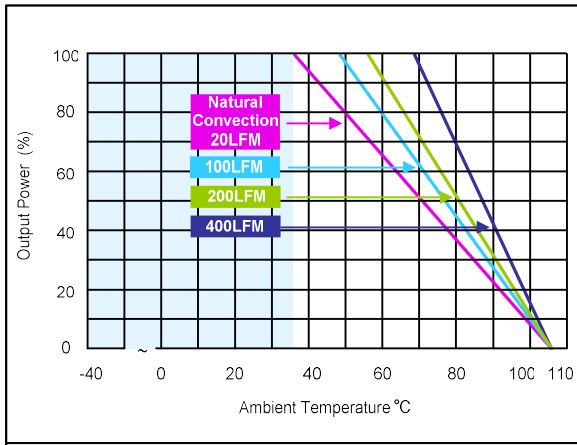

Figure 43: ERM15A110 Derating Curve without Heatsink
 Vin = 110Vdc Load: Io = 0 to 15A

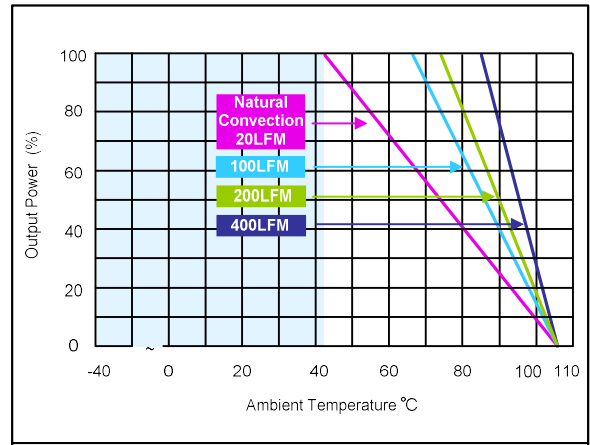

Figure 44: ERM15A110 Derating Curve with Heatsink
 Vin = 110Vdc Load: Io = 0 to 15A

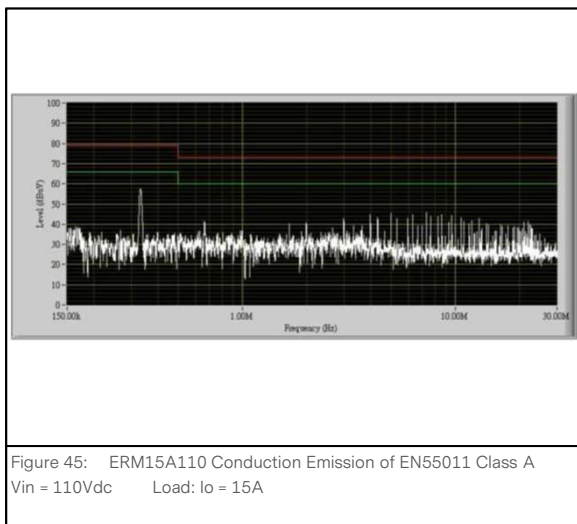

Figure 45: ERM15A110 Conduction Emission of EN55011 Class A
 Vin = 110Vdc Load: Io = 15A

Note - All test conditions are at 25 °C

ELECTRICAL SPECIFICATIONS

ERM06B110 Performance Curves

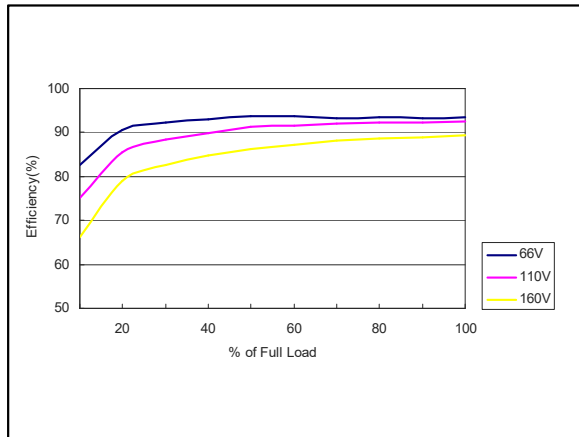

Figure 46: ERM06B110 Efficiency Versus Output Current Curve
 Vin = 66 to 160Vdc Load: Io = 0 to 6.25A

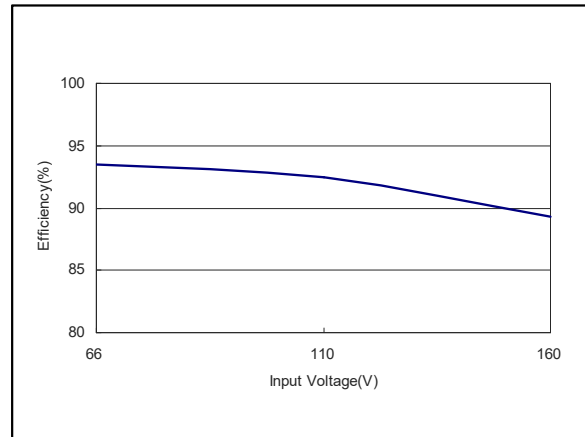

Figure 47: ERM06B110 Efficiency Versus Input Voltage Curve
 Vin = 66 to 160Vdc Load: Io = 0 to 6.25A



Figure 48: ERM06B110 Typical Output Ripple and Noise.
 Vin = 110Vdc Load: Io = 6.25A
 Ch 1: Vo

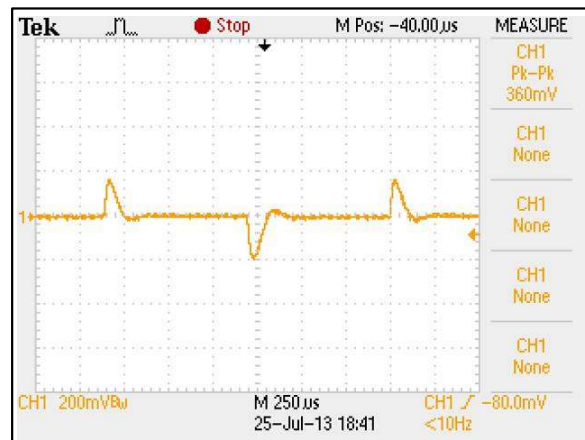

Figure 49: ERM06B110 Transient Response
 Vin = 110Vdc Load: Io = 100% to 75% load change
 Ch 1: Vo

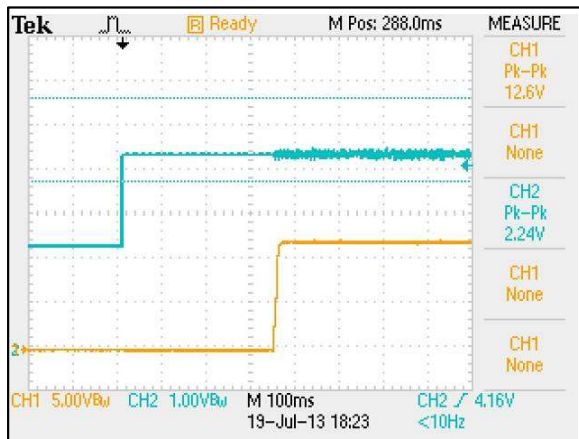

Figure 50: ERM06B110 Output Voltage Startup Characteristic by On/Off
 Vin = 110Vdc Load: Io = 6.25A
 Ch 1: Vo Ch 2: Remote On/Off

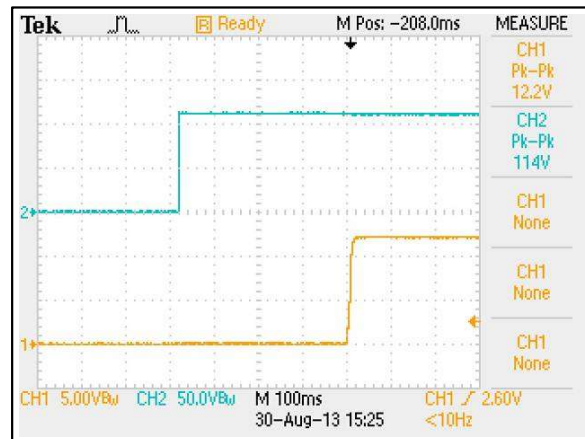

Figure 51: ERM06B110 Output Voltage Startup Characteristic by Vin
 Vin = 110Vdc Load: Io = 6.25A
 Ch 1: Vo Ch 2: Vin

ELECTRICAL SPECIFICATIONS

ERM06B110 Performance Curves

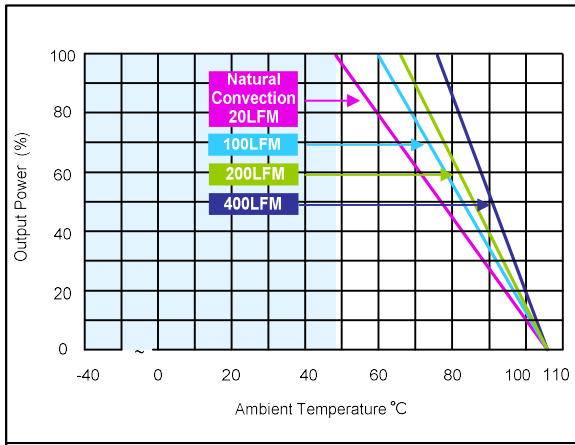

Figure 52: ERM06B110 Derating Curve without Heatsink
 Vin = 110Vdc Load: Io = 0 to 6.25A

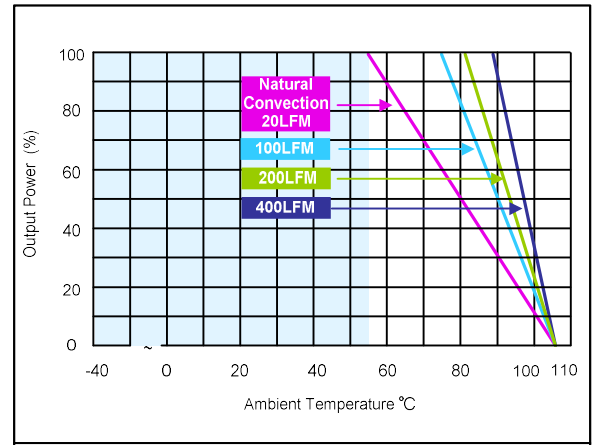

Figure 53: ERM06B110 Derating Curve with Heatsink
 Vin = 110Vdc Load: Io = 0 to 6.25A

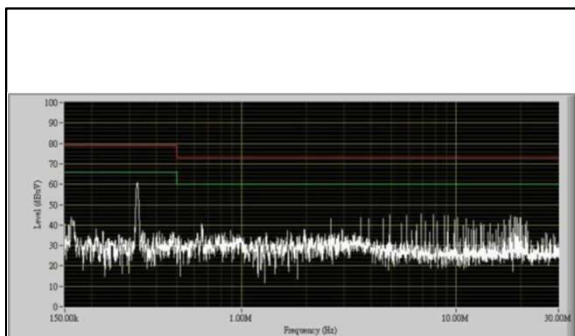

Figure 54: ERM06B110 Conduction Emission of EN55011 Class A
 Vin = 110Vdc Load: Io = 6.25A

Note - All test conditions are at 25 °C

ELECTRICAL SPECIFICATIONS

ERM05C110 Performance Curves

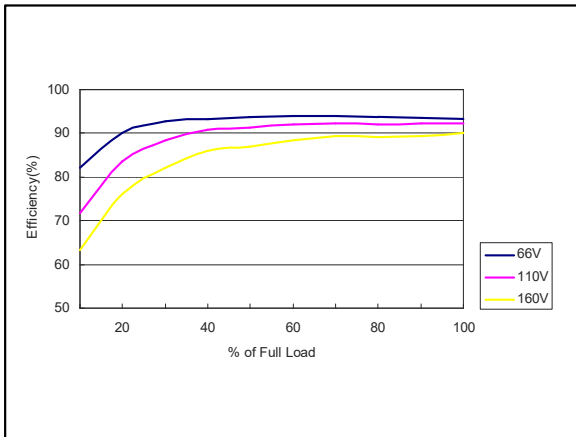

Figure 55: ERM05C110 Efficiency Versus Output Current Curve
 Vin = 66 to 160Vdc Load: Io = 0 to 5A

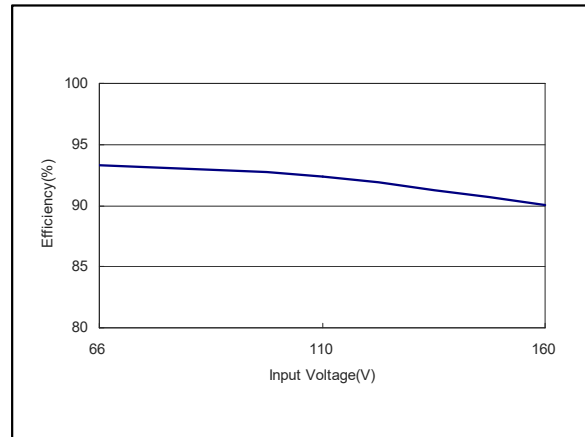

Figure 56: ERM05C110 Efficiency Versus Input Voltage Curve
 Vin = 66 to 160Vdc Load: Io = 0 to 5A

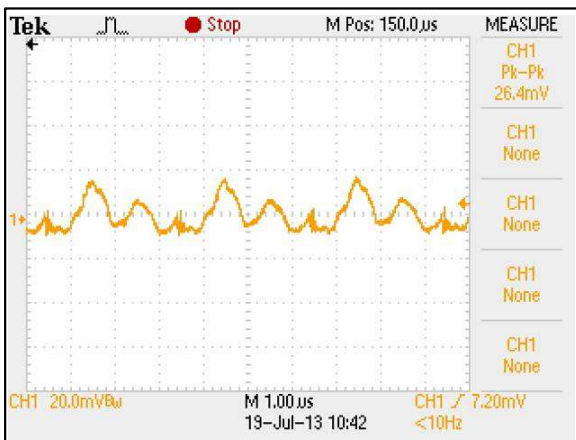

Figure 57: ERM05C110 Typical Output Ripple and Noise.
 Vin = 110Vdc Load: Io = 5A
 Ch 1: Vo

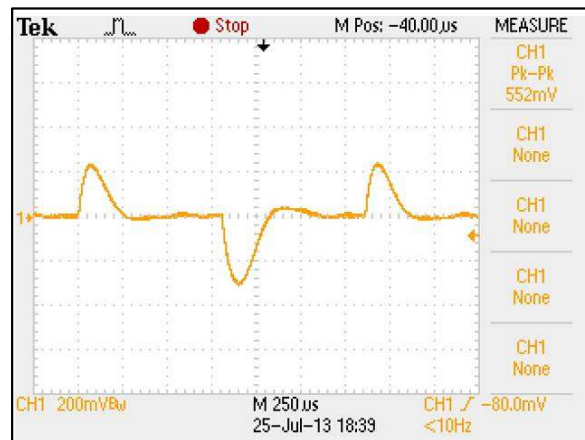

Figure 58: ERM05C110 Transient Response
 Vin = 110Vdc Load: Io = 100% to 75% load change
 Ch 1: Vo

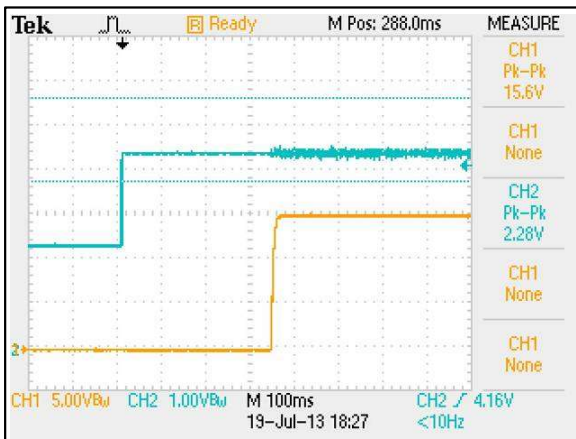

Figure 59: ERM05C110 Output Voltage Startup Characteristic by On/Off
 Vin = 110Vdc Load: Io = 5A
 Ch 1: Vo Ch 2: Remote On/Off

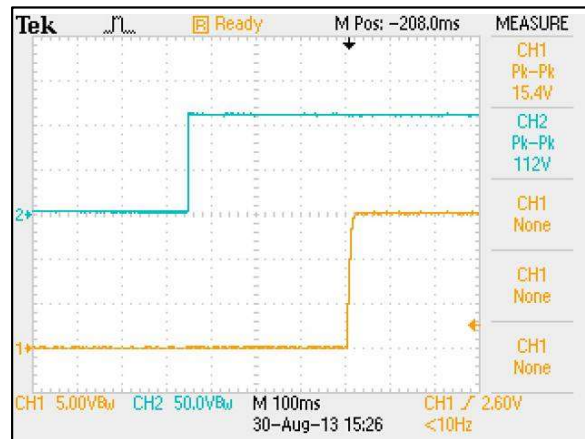

Figure 60: ERM05C110 Output Voltage Startup Characteristic by Vin
 Vin = 110Vdc Load: Io = 5A
 Ch 1: Vo Ch 2: Vin

ELECTRICAL SPECIFICATIONS

ERM05C110 Performance Curves

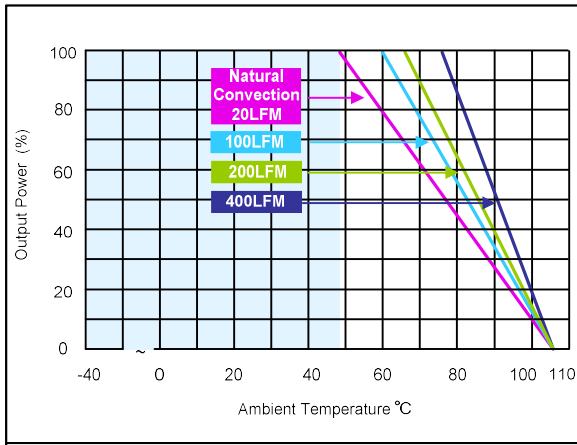

Figure 61: ERM05C110 Derating Curve without Heatsink
 Vin = 110Vdc Load: Io = 0 to 5A

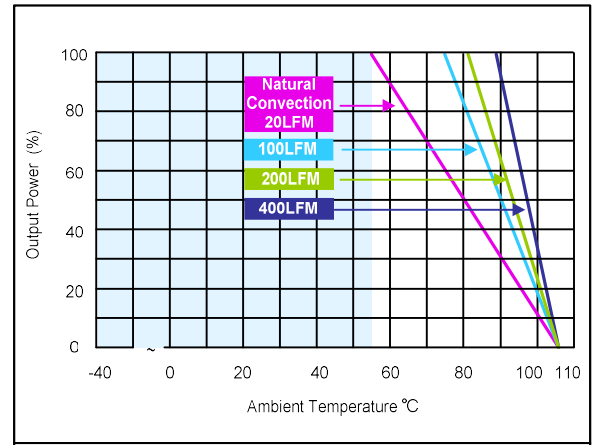

Figure 62: ERM05C110 Derating Curve with Heatsink
 Vin = 110Vdc Load: Io = 0 to 5A

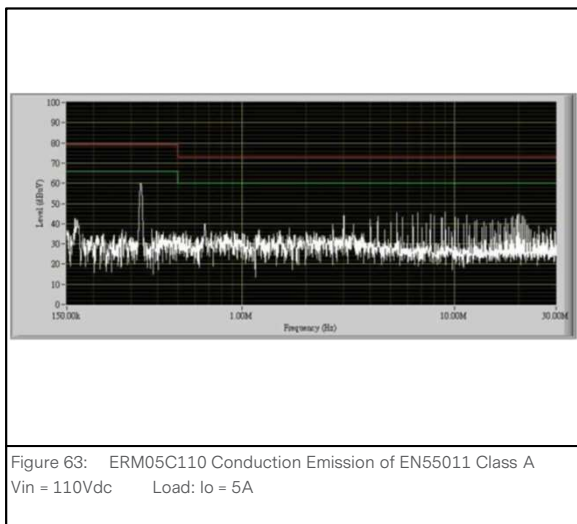

Figure 63: ERM05C110 Conduction Emission of EN55011 Class A
 Vin = 110Vdc Load: Io = 5A

Note - All test conditions are at 25 °C

ELECTRICAL SPECIFICATIONS

ERM03H110 Performance Curves

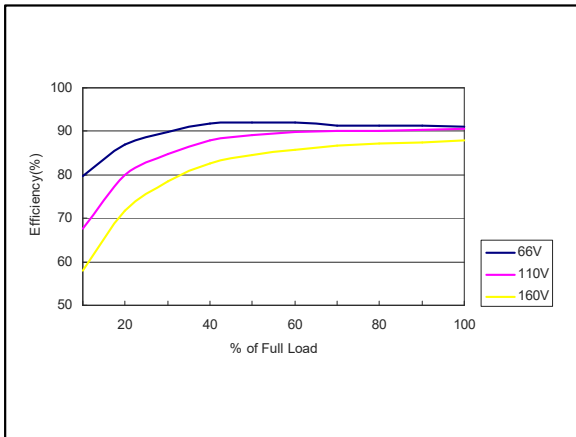

Figure 64: ERM03H110 Efficiency Versus Output Current Curve
 Vin = 66 to 160Vdc Load: Io = 0 to 3.125A

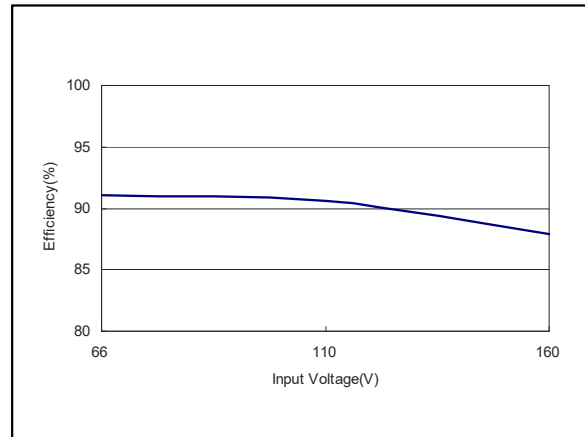

Figure 65: ERM03H110 Efficiency Versus Input Voltage Curve
 Vin = 66 to 160Vdc Load: Io = 0 to 3.125A

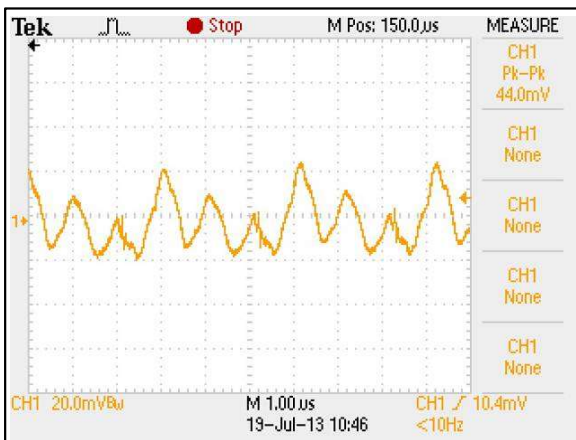

Figure 66: ERM03H110 Typical Output Ripple and Noise.
 Vin = 110Vdc Load: Io = 3.125A
 Ch 1: Vo

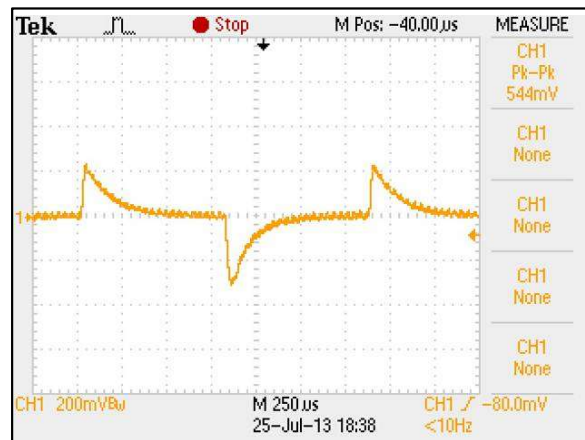

Figure 67: ERM03H110 Transient Response
 Vin = 110Vdc Load: Io = 100% to 75% load change
 Ch 1: Vo

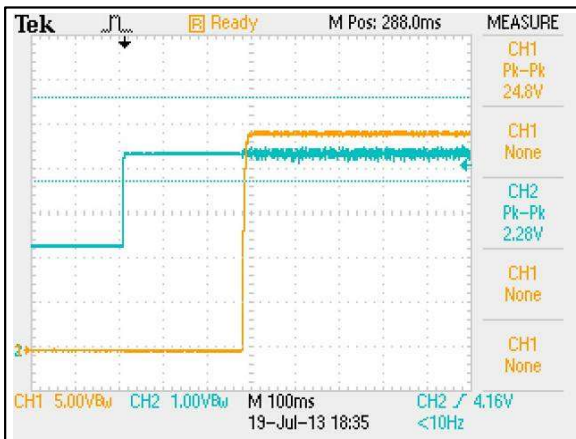

Figure 68: ERM03H110 Output Voltage Startup Characteristic by On/Off
 Vin = 110Vdc Load: Io = 3.125A
 Ch 1: Vo Ch 2: Remote On/Off

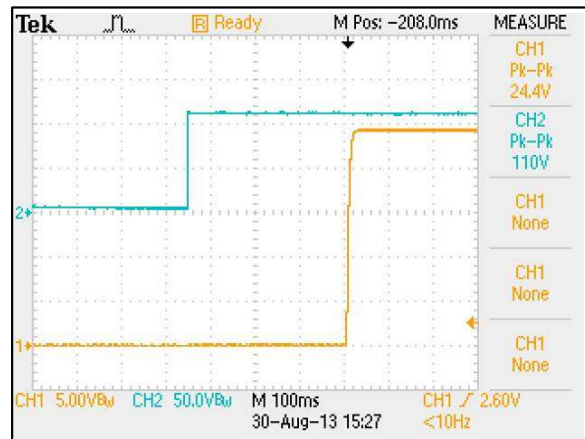

Figure 69: ERM03H110 Output Voltage Startup Characteristic by Vin
 Vin = 110Vdc Load: Io = 3.125A
 Ch 1: Vo Ch 2: Vin

ELECTRICAL SPECIFICATIONS

ERM03H110 Performance Curves

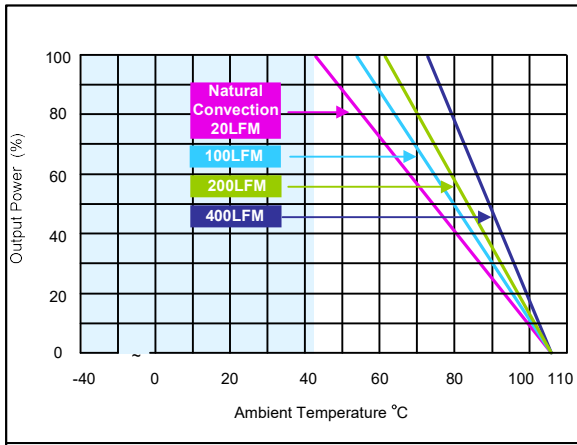

Figure 70: ERM03H110 Derating Curve without Heatsink
 Vin = 110Vdc Load: Io = 0 to 3.125A

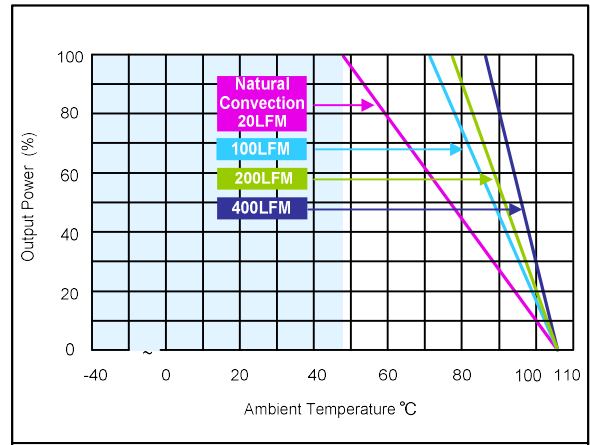

Figure 71: ERM03H110 Derating Curve with Heatsink
 Vin = 110Vdc Load: Io = 0 to 3.125A

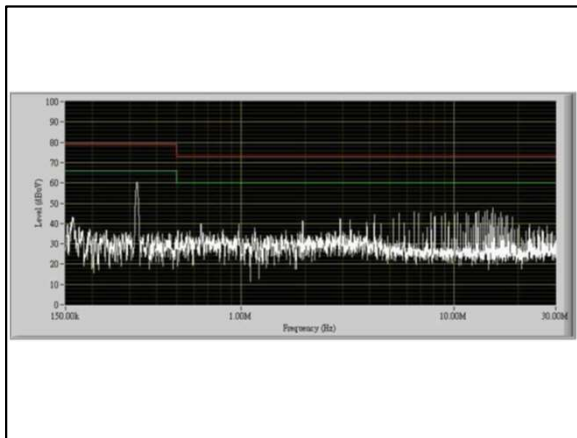

Figure 72: ERM03H110 Conduction Emission of EN55011 Class A
 Vin = 110Vdc Load: Io = 3.125A

Note - All test conditions are at 25 °C

ELECTRICAL SPECIFICATIONS

Protection Function Specification

Over Voltage Protection (OVP)

The output overvoltage clamp consists of control circuitry, which is independent of the primary regulation loop, that monitors the voltage on the output terminals. The control loop of the clamp has a higher voltage set point than the primary loop. This provides a redundant voltage control that reduces the risk of output overvoltage.

Parameter		Min	Nom	Max	Unit
V _O Output Overvoltage	ERM15A72 ERM15A110	/	6.2	/	Vdc
	ERM06B72 ERM06B110	/	15	/	Vdc
	ERM05C72 ERM05C110	/	18	/	Vdc
	ERM03H72 ERM03H110	/	30	/	Vdc

Over Temperature Protection (OTP)

Over Temperature (non-latching), base plate temperature.

Parameter	Min	Nom	Max	Unit
Over - temperature	-50	/	110	°C

Over Current Protection (OCP)

Current Limitation at 150% typ. of I_{out} max., Hiccup mode. To provide hiccup mode protection in a fault (output overload) condition, the unit is equipped with internal current limiting circuitry and can endure overload for an unlimited duration.

Parameter		Min	Nom	Max	Unit
V _O Output Overcurrent	ERM15A72 ERM15A110	/	22.50	/	A
	ERM06B72 ERM06B110	/	9.38	/	A
	ERM05C72 ERM05C110	/	7.50	/	A
	ERM03H72 ERM03H110	/	4.69	/	A

MECHANICAL SPECIFICATIONS

Mechanical Outlines

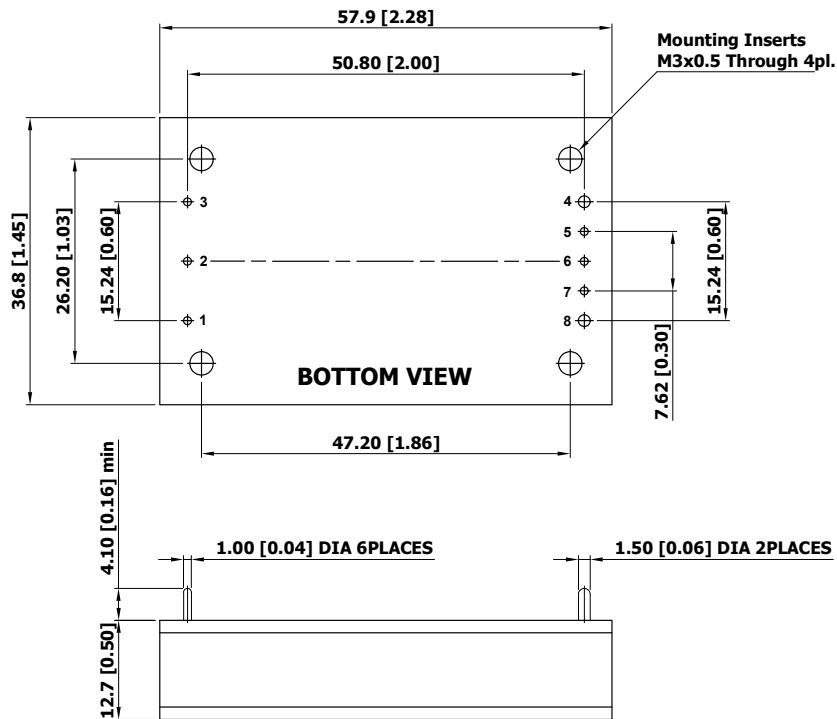

Pin Connections

Pin 1	-	+Vin
Pin 2	-	Remote On/Off
Pin 3	-	-Vin
Pin 4	-	-Vout
Pin 5	-	-Sense(8)
Pin 6	-	Trim
Pin 7	-	+Sense(8)
Pin 8	-	+Vout

Note:

- If remote sense not used, the +sense should be connected to +output and -sense should be connected to -output.
- All dimensions in mm (inches)
Tolerance: $X.X \pm 0.5$ ($X.XX \pm 0.02$)
 $X.XX \pm 0.25$ ($X.XXX \pm 0.01$)
- Pin diameter: 1.0 ± 0.05 (0.04 ± 0.002)
- Pin diameter: 1.5 ± 0.05 (0.06 ± 0.002)

MECHANICAL SPECIFICATIONS

Physical Characteristics

Case Size	57.9x36.8x12.7 mm (2.28x1.45x0.5 inches)
Case Material	Aluminum Frame with Black Anodized Coating
Top Side Base Material	Aluminum Plate
Bottom Side Base Material	Non-conductive Black Plastic Base Plate
Potting Material	Epoxy (UL94-V0)

Heatsink (Option -HS)

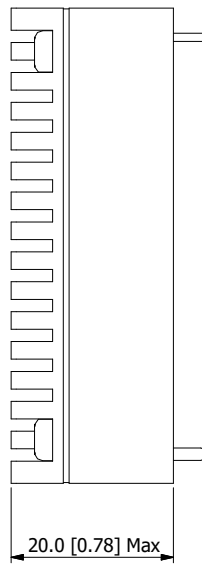
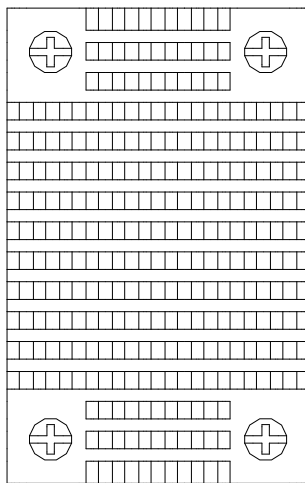

Heatsink Material: Aluminum
 Finish: Black Anodized Coating
 Weight: 13g

The advantages of adding a heatsink are:

1. To help heat dissipation and increase the stability and reliability of DC/DC converters at high operating temperature atmosphere.
2. To upgrade the operating temperature of DC/DC converters, please refer to Derating Curve.

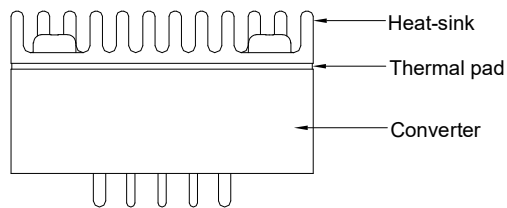

MECHANICAL SPECIFICATIONS

Recommended Pad Layout

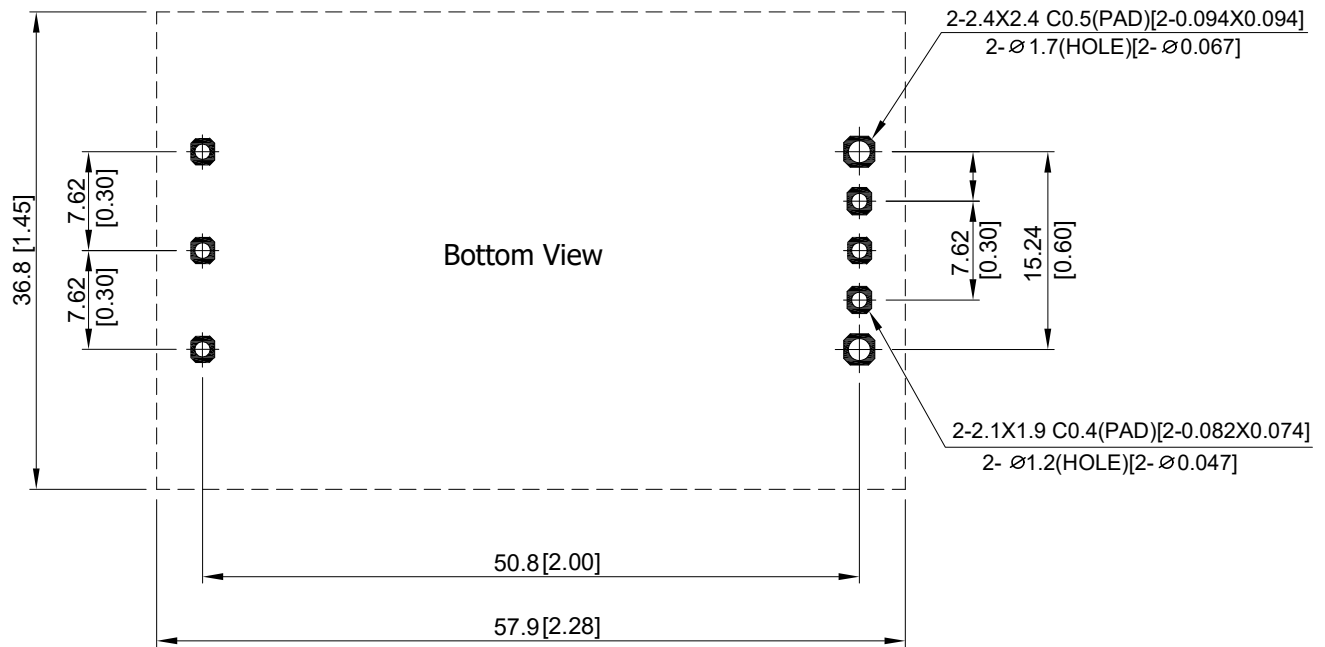

ENVIRONMENTAL SPECIFICATIONS

EMC Immunity

ERM75 series power supply is designed to meet the following EMC immunity specifications. The ERM75 series can meet EN61000-4-4 & EN61000-4-5 by adding a capacitor across the input pins. Suggested capacitor: CHEMI-CON KXG 470uF/200V.

Table 4. EMC Specifications

Parameter	Standards & Level		Performance
General	Compliance with EN 50121-3-2 Railway Applications		
EMI	EN55022, EN55011, FCC part15		Class A
EMS	EN55024		
	ESD	EN61000-4-2 air $\pm 8\text{KV}$, Contact $\pm 6\text{KV}$	Perf. Criteria A
	Radiated immunity	EN61000-4-3 10V/m	Perf. Criteria A
	Fast transient	EN61000-4-4 $\pm 2\text{KV}$	Perf. Criteria A
	Surge	EN61000-4-5 $\pm 1\text{KV}$	Perf. Criteria A
	Conducted immunity	EN61000-4-6 10Vrms	Perf. Criteria A

ENVIRONMENTAL SPECIFICATIONS

Safety Certifications

The ERM75 power supply is intended for inclusion in other equipment and the installer must ensure that it is in compliance with all the requirements of the end application. This product is only for inclusion by professional installers within other equipment and must not be operated as a stand alone product.

Table 5. Safety Certifications for ERM75 series power supply system	
Document	Description
cUL/UL 60950-1	US and Canada Requirements
IEC/EN 60950-1	European Requirements
IEC/EN 50155	Railway standard
IEC60571	Railway standard
CE	European Requirements

ENVIRONMENTAL SPECIFICATIONS

Operating Temperature

Parameter	Model / Condition	Min	Max		Unit
			Without Heatsink	With Heatsink	
Operating Ambient Temperature Range Natural Convection ¹ Nominal Vin, Load 100% Inom	ERM06B72	-40	56	61	°C
	ERM05C72		56	61	
	ERM05C110		49	55	
	ERM03H72		49	55	
	ERM06B110		49	55	
	ERM03H110		43	48	
	ERM15A72		36	42	
	ERM15A110		36	42	
Thermal Impedance	Natural Convection without Heatsink	7.5	-	-	°C/W
	Natural Convection with Heatsink	6.8	-	-	
	100LFM Convection without Heatsink	6.1	-	-	
	100LFM Convection with Heatsink	4.1	-	-	
	200LFM Convection without Heatsink	5.3	-	-	
	200LFM Convection with Heatsink	3.3	-	-	
	400LFM Convection without Heatsink	3.9	-	-	
400LFM Convection with Heatsink	2.2	-	-		
Operating Base-plate Temperature Range		-40	+105		°C
RFI	Six-Sided Shielded, Metal Case				
Lead Temperature (1.5mm from case for 10Sec.)		-	260		°C

Note1 - The "natural convection" is about 20LFM but is not equal to still air (0 LFM).

ENVIRONMENTAL SPECIFICATIONS

MTBF and Reliability

The MTBF of ERM75 series of DC/DC converters has been calculated using MIL-HDBK 217F NOTICE2, Operating Temperature 25 °C, Ground Benign.

Model	MTBF	Unit
ERM15A72	144,400	Hours
ERM06B72	316,000	
ERM05C72	292,200	
ERM03H72	259,100	
ERM15A110	143,800	
ERM06B110	265,900	
ERM05C110	248,800	
ERM03H110	210,400	

POWER AND CONTROL SIGNAL DESCRIPTIONS

Power and Signal Pins

These pins provide power and signal interface to the ERM75 series module.

Pin 1	- Vin (+)	- Input Voltage Positive
Pin 2	- Remote On/Off	- ON / OFF Control
Pin 3	- Vin (-)	- Input Voltage Return
Pin 4	- Vout (-)	- Output Voltage Return
Pin 5	- SENSE (-)	- Remote Sense Return
Pin 6	- TRIM	- Output Voltage Trim
Pin 7	- SENSE (+)	- Remote Sense Positive
Pin 8	- Vout (+)	- Output Voltage Positive

Vin (+), Vin (-) – (Pins 1, 3)

These pins are the Input Voltage Positive and Input Voltage Return pins of the module.

Remote On/Off – (Pin 2)

Remote On/Off pin allows the user to turn ON and OFF the output of the ERM75 series modules.

Parameter	Conditions	Min.	Typ.	Max.	Unit
Converter On	3.5V ~ 12V or Open Circuit				
Converter Off	0V ~ 1.2V or Short Circuit				
Control Input Current (on)	Vctrl = 5.0V	-	0.5	-	mA
Control Input Current (off)	Vctrl = 0V	-	-0.5	-	mA
Control Common	Referenced to Negative Input				
Standby Input Current	Nominal Vin	-	2.5	-	mA

Vout (+), Vout (-) – (Pins 8, 4)

These pins are the Output Voltage Positive and Output Voltage Return pins of the module.

SENSE (+), SENSE (-) – (Pins 7, 5)

The ERM75 is equipped with a Remote Sensing capability that will compensate for voltage drop between the output pins of the module and the sensed voltage point (load). This feature is implemented by connecting the SENSE (+) (pin 7) and the SENSE (-) (pin 5) to the positive and return rails of the output, respectively, at a location that is near to the load. Care should be taken in the routing of the sense lines as any noise sources or additional filtering components introduced into the output voltage rail may affect the stability of the power supply. The ERM75 series will operate appropriately without the sense lines connected; however it is recommended that the sense lines be connected directly to the output pins if remote sensing is not required.

POWER AND CONTROL SIGNAL DESCRIPTIONS

TRIM – (Pin 6)

Output can be externally trimmed by using the method shown below. The trim up/down range is $\pm 10\%$ minimum of the nominal output voltage.

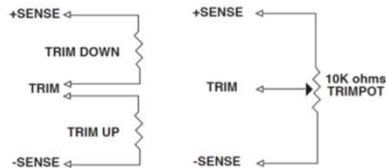

ERM15AXX Trim Table:

Trim down	1	2	3	4	5	6	7	8	9	10	%
Vout=	Vox0.99	Vox0.98	Vox0.97	Vox0.96	Vox0.95	Vox0.94	Vox0.93	Vox0.92	Vox0.91	Vox0.90	Vdc
Rd=	45.53	20.61	12.31	8.15	5.66	4.00	2.81	1.92	1.23	0.68	KOhm
Trim up	1	2	3	4	5	6	7	8	9	10	%
Vout=	Vox1.01	Vox1.02	Vox1.03	Vox1.04	Vox1.05	Vox1.06	Vox1.07	Vox1.08	Vox1.09	Vox1.10	Vdc
Ru=	36.57	16.58	9.92	6.59	4.59	3.25	2.30	1.59	1.03	0.59	KOhm

ERM06BXX Trim Table:

Trim down	1	2	3	4	5	6	7	8	9	10	%
Vout=	Vox0.99	Vox0.98	Vox0.97	Vox0.96	Vox0.95	Vox0.94	Vox0.93	Vox0.92	Vox0.91	Vox0.90	Vdc
Rd=	394.50	179.74	106.08	68.86	46.39	31.36	20.60	12.51	6.21	1.17	KOhm
Trim up	1	2	3	4	5	6	7	8	9	10	%
Vout=	Vox1.01	Vox1.02	Vox1.03	Vox1.04	Vox1.05	Vox1.06	Vox1.07	Vox1.08	Vox1.09	Vox1.10	Vdc
Ru=	368.92	161.92	94.97	61.86	42.12	29.00	19.66	12.66	7.23	2.89	KOhm

ERM05CXX Trim Table:

Trim down	1	2	3	4	5	6	7	8	9	10	%
Vout=	Vox0.99	Vox0.98	Vox0.97	Vox0.96	Vox0.95	Vox0.94	Vox0.93	Vox0.92	Vox0.91	Vox0.90	Vdc
Rd=	572.67	248.63	145.60	94.97	64.87	44.92	30.72	20.10	11.86	5.28	KOhm
Trim up	1	2	3	4	5	6	7	8	9	10	%
Vout=	Vox1.01	Vox1.02	Vox1.03	Vox1.04	Vox1.05	Vox1.06	Vox1.07	Vox1.08	Vox1.09	Vox1.10	Vdc
Ru=	392.98	182.12	108.73	71.43	48.85	33.71	22.86	14.69	8.33	3.23	KOhm

ERM03HXX Trim Table:

Trim down	1	2	3	4	5	6	7	8	9	10	%
Vout=	Vox0.99	Vox0.98	Vox0.97	Vox0.96	Vox0.95	Vox0.94	Vox0.93	Vox0.92	Vox0.91	Vox0.90	Vdc
Rd=	512	229.6	138.3	90.3	60.7	42.4	29.04	18.67	11.09	4.78	KOhm
Trim up	1	2	3	4	5	6	7	8	9	10	%
Vout=	Vox1.01	Vox1.02	Vox1.03	Vox1.04	Vox1.05	Vox1.06	Vox1.07	Vox1.08	Vox1.09	Vox1.10	Vdc
Ru=	574	256.9	149.6	96.5	64.7	43.28	27.68	16.72	7.68	1.11	KOhm

APPLICATION NOTES

Input Reflected-Ripple Current Test Setup

Input reflected-ripple current is measured with an inductor L_{in} ($4.7\mu\text{H}$) and C_{in} ($220\mu\text{F}$, $\text{ESR} < 1.0\Omega$ at 100 KHz) to simulate source impedance. Capacitor C_{in} , offsets possible battery impedance. Current ripple is measured at the input terminals of the module, measurement bandwidth is $0\text{-}500\text{ KHz}$.

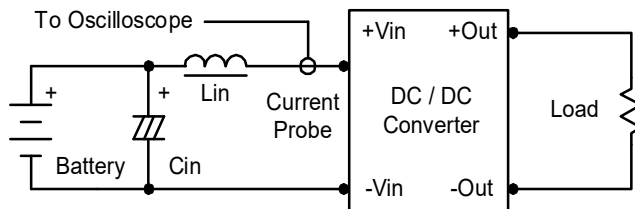

Component	Value	Reference
L_{in}	$4.7\mu\text{H}$	-
C_{in}	$220\mu\text{F}$ ($\text{ESR} < 1.0\Omega$ at 100KHz)	Aluminum Electrolytic Capacitor

Output Ripple Reduction

A good quality low ESR capacitor placed as close as practicable across the load will give the best ripple and noise performance. To reduce output ripple, it is recommended to use $4.7\mu\text{F}$ capacitors at the output.

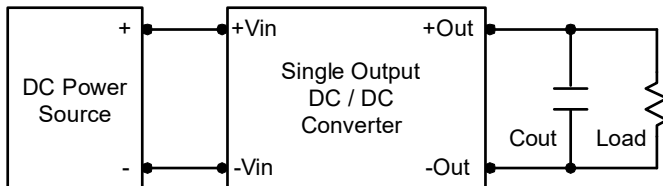

Peak-to-Peak Output Noise Measurement Test

Refer to the output specifications or add $4.7\mu\text{F}$ capacitor if the output specifications undefine C_{out} . Scope measurement should be made by using a BNC socket, measurement bandwidth is $0\text{-}20\text{MHz}$. Position the load between 50 mm and 75 mm from the DC/DC Converter.

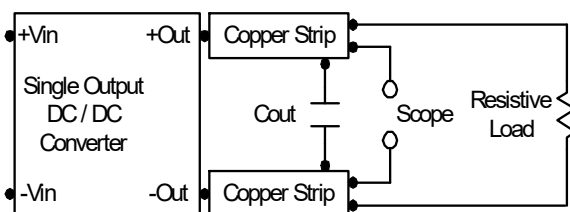

APPLICATION NOTES

Maximum Capacitive Load

The ERM75 series has limitation of maximum connected capacitance at the output. The power module may be operated in current limiting mode during start-up, affecting the ramp-up and the startup time. The maximum capacitance can be found in below table.

Thermal Considerations

Many conditions affect the thermal performance of the power module, such as orientation, airflow over the module and board spacing. To avoid exceeding the maximum temperature rating of the components inside the power module, the case temperature must be kept below 105 °C. The derating curves are determined from measurements obtained in a test setup.

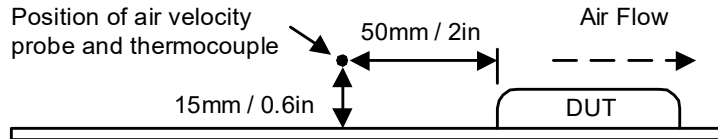

Output voltage and efficiency measurement test up

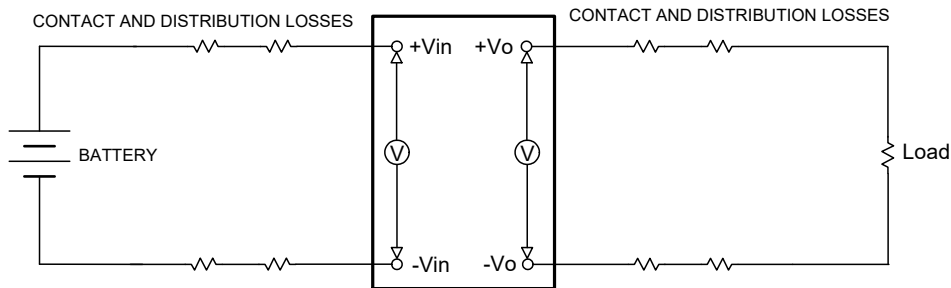

$$\text{Efficiency} = \left(\frac{V_{out} \times I_{out}}{V_{in} \times I_{in}} \right) \times 100\% = [\%]$$

APPLICATION NOTES

EMI Emissions

Recommended circuit to comply EN55011 / EN55022 Class A Limits

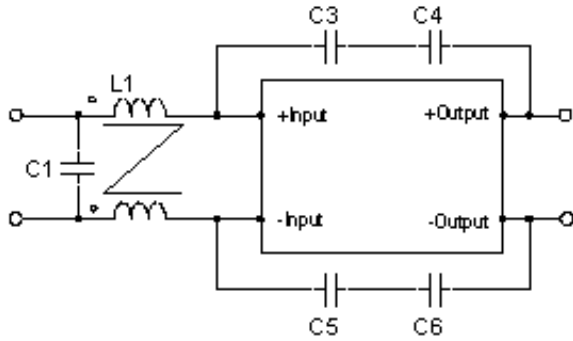

Recommended PCB Layout with Input Filter

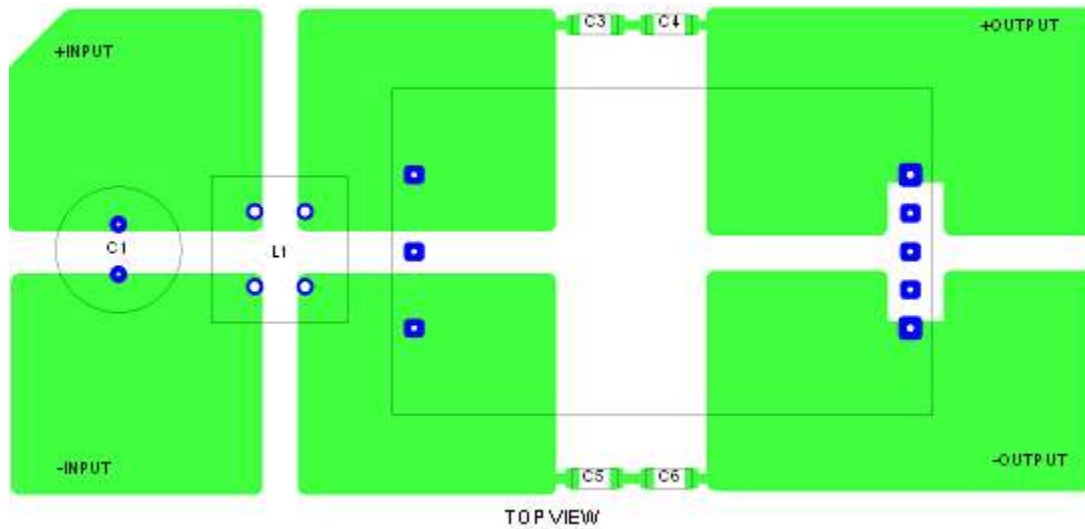

To comply with EN55011 / EN55022 CLASS A following components are needed:

Model	Component	Value
ERM75 Series	C1	CHEMI-CON KXG Series 68uF/200V
	C3,C4,C5,C6	2200pF/3KV
	L1	450μH/450μH

APPLICATION NOTES

Input Source Impedance

The power module should be connected to a low ac-impedance input source. Highly inductive source impedances can affect the stability of the power module.

In applications where power is supplied over long lines and output loading is high, it may be necessary to use a capacitor at the input to ensure startup.

Capacitor mounted close to the power module helps ensure stability of the unit, it is recommended to use a capacitor of a 3.3uF for the 72V input devices and a 1uF for the 110V input devices.

Remote ON/OFF Control

Positive logic remote on/off turns the module on during a logic high voltage on the remote on/off pin, and off during a logic low. To turn the power module on and off, the user must supply a switch to control the voltage between the on/off terminal and the -Vin terminal. The switch can be an open collector or equivalent. A logic low is 0V to 1.2V. A logic high is 3.5V to 12V. The maximum sink current at the on/off terminal (Pin 3) during a logic low is -100uA. The ON/OFF input signal (Von/off) that referenced to GND. If not using the remote on/off feature, please open circuit between on/off pin and -Vin pin to turn the module on. Remote ON/OFF implementation is below.

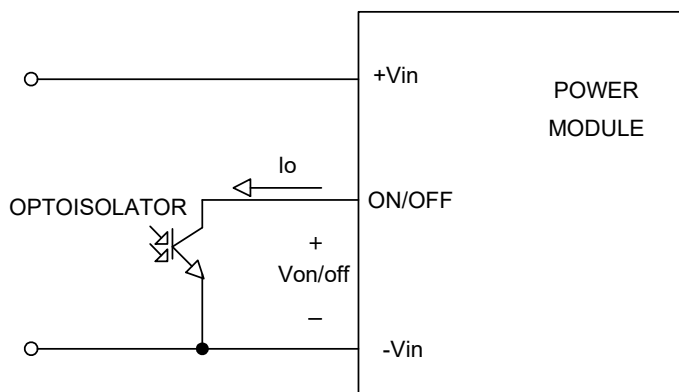

Isolated-Closure Remote ON/OFF

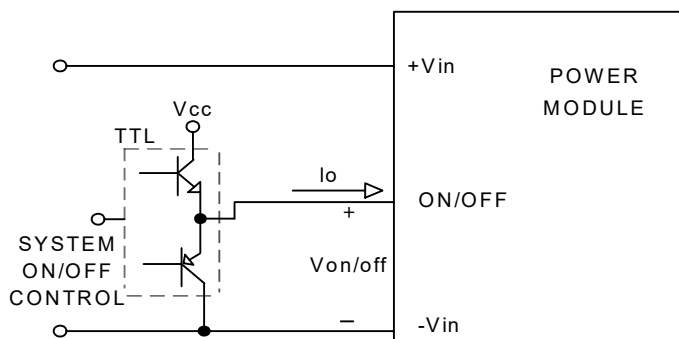

Level Control Using TTL Output

APPLICATION NOTES

Packaging Information

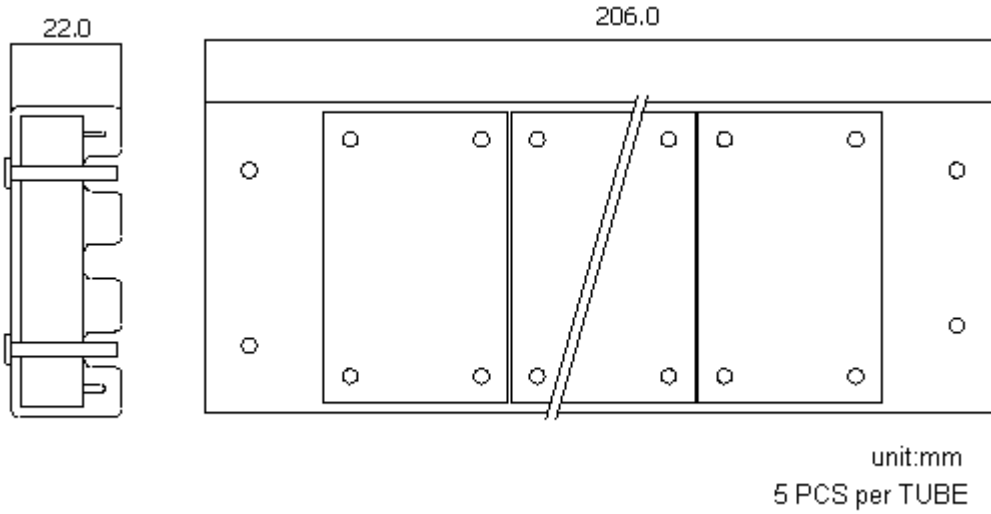

Soldering and Reflow Considerations

Lead free wave solder profile for ERM75 Series

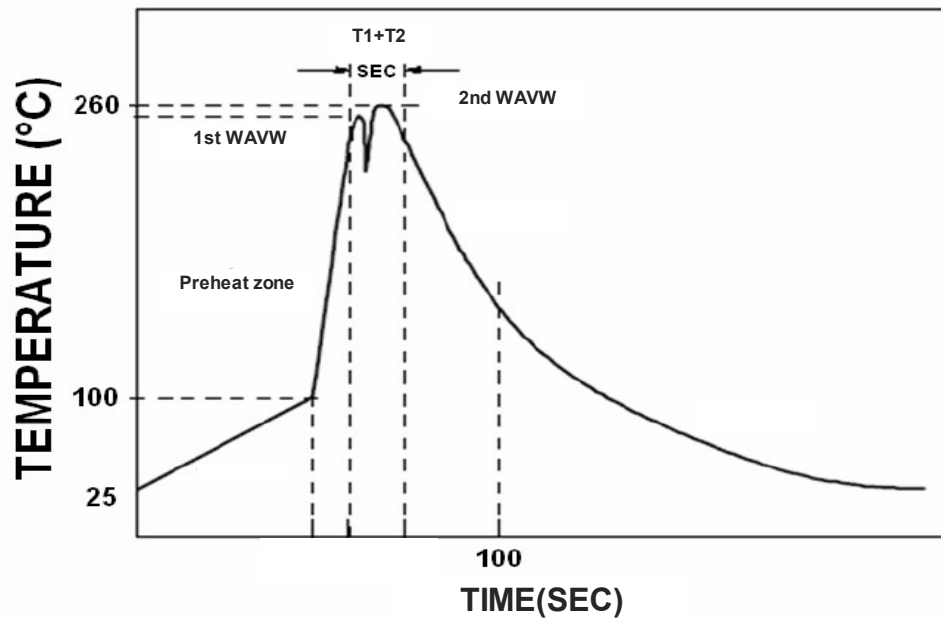

Weight

The ERM75 series weight is 0.13 lb. (61 grams) maximum.

RECORD OF REVISION AND CHANGES

Issue	Date	Description	Originators
1.0	11.05.2013	First Issue	E. Wang
1.1	02.17.2014	Update the operating temperature description and OVP level	E. Wang
1.2	03.06.2014	Update input UVP specification	E. Wang
1.3	05.28.2014	Update EMI level	E. Wang
1.4	06.13.2014	Duncan update	E. Wang
1.5	09.23.2014	Duncan update	E. Wang
1.6	10.14.2014	Duncan update	E. Wang
1.7	03.29.2017	Update ripple & noise output capacitor value	E. Wang
1.8	02.08.2018	Update operating temperature	E. Wang



For international contact information,
visit advancedenergy.com.

powersales@aei.com (Sales Support)
productsupport.ep@aei.com (Technical Support)
+1 888 412 7832

ABOUT ADVANCED ENERGY

Advanced Energy (AE) has devoted more than three decades to perfecting power for its global customers. AE designs and manufactures highly engineered, precision power conversion, measurement and control solutions for mission-critical applications and processes.

Our products enable customer innovation in complex applications for a wide range of industries including semiconductor equipment, industrial, manufacturing, telecommunications, data center computing, and medical. With deep applications know-how and responsive service and support across the globe, we build collaborative partnerships to meet rapid technological developments, propel growth for our customers, and innovate the future of power.

PRECISION | POWER | PERFORMANCE

Specifications are subject to change without notice. Not responsible for errors or omissions. ©2020 Advanced Energy Industries, Inc. All rights reserved. Advanced Energy®, and AE® are U.S. trademarks of Advanced Energy Industries, Inc.