

ARTESYN DS2400SPE SERIES

2400 Watts Distributed Power System



PRODUCT DESCRIPTION

Advanced Energy's Artesyn DS2400SPE series power supply features an input range of 90 to 140 Vac, and 180 to 264 Vac. It employs active power factor correction to minimize input harmonic current distortion and to ensure compliance with the international EN61000-3-2 standard — they have a power factor of 0.99 at full load. The power supplies also feature active AC inrush control, to automatically limit inrush current at turn-on to 45 A maximum.

SPECIAL FEATURES

- 2400W output power at high line
- 1U power supply
- High power and short form factor
- High density design: 62W/in³
- Active power factor correction
- EN61000-3-2 harmonic compliance
- Inrush current control
- 80 PLUS® Platinum efficiency
- N+N, N+1 redundant
- Hot-pluggable
- Active current sharing
- Cold redundancy
- Two-year warranty
- RoHS
- Class A conducted / radiated EMI

- PMBus™ compliant

SAFETY

- UL/cUL 60950 (UL Recognized)
- DEMKO+CB Report
- EN60950
- CE and UKCA Mark
- BSMI
- KC
- EAC
- BIS

TYPICAL APPLICATIONS

- Industrial

AT A GLANCE

Total Power:

2400 Watts

Input Voltage:

90 to 140 Vac

180 to 264 Vac

of Outputs:

Main and Standby



MODEL NUMBERS

Standard	Output Voltage	Minimum Load ¹	Maximum Load	Stand-By Supply	Air Flow Direction
DS2400SPE-3	12.2Vdc	0A	196.72A	12.0Vdc@3.5A	Normal (DC Connector to Handle)
DS2400SPE-3-001	12.2Vdc	0A	196.72A	12.0Vdc@3.5A	Reverse (Handle to DC Connector)

Note 1 - Unit is designed to operate and be within output regulation range at zero load.

Options

None

ELECTRICAL SPECIFICATIONS

Absolute Maximum Ratings

Stress in excess of those listed in the “Absolute Maximum Ratings” may cause permanent damage to the power supply. These are stress ratings only and functional operation of the unit is not implied at these or any other conditions above those given in the operational sections of this TRN. Exposure to any absolute maximum rated condition for extended periods may adversely affect the power supply’s reliability.

Table 1. Absolute Maximum Ratings						
Parameter	Models	Symbol	Min	Typ	Max	Unit
Input Voltage AC continuous operation	All models	$V_{IN,AC}$	90	-	140	Vac
		$V_{IN,AC}$	180	-	264	Vac
Maximum Output Power $V_{IN,AC} = 90 - 140Vac$ $V_{IN,AC} = 180 - 264Vac$	All models	$P_{O,max}$	-	-	1400	W
	All models	$P_{O,max}$	-	-	2400	W
Isolation Voltage Input to outputs Input to safety ground	All models		-	-	2951	Vdc
	All models		-	-	4243	Vdc
Ambient Operating Temperature ¹	Forward air	T_A	0	-	50	°C
	Reverse air		0	-	40	°C
Storage Temperature	All models	T_{STG}	-40	-	70	°C
Humidity (non-condensing) Operating Non-operating	All models		5	-	95	%
	All models		5	-	95	%
Altitude ² Operating Non-operating	All models		-	-	10000	Feet
	All models		-	-	50000	Feet
MTBF Telcordia Issue 3	All models		200	-	-	KHours
Operating Life	All models		5	-	-	Years

Note 1 - Forward air: allowable up to 60°C at 1800W high line / 1200W low line. Reverse air: allowable up to 50°C at 1700W high line / 1200W low line.

Note 2 - Derating please see page 20.

ELECTRICAL SPECIFICATIONS

Input Specifications

Table 2. Input Specifications							
Parameter	Condition	Symbol	Min	Typ	Max	Unit	
Operating Input Voltage, AC	Low Line	All	$V_{IN,AC}$	90	115	140	Vac
	High Line	All	$V_{IN,AC}$	180	230	264	Vac
Operating Input Voltage, DC	All	$V_{IN,DC}$	180	264	300	Vdc	
Input AC Frequency	All	$f_{IN,AC}$	47	50/60	63	Hz	
Input AC Start-up Voltage	Low Line		$V_{IN,AC-start}$	84	-	90	Vac
	High Line		$V_{IN,AC-start}$	174	-	180	Vac
Input AC Under-voltage Lockout Voltage	Low Line		$V_{IN,AC-stop}$	-	-	80	Vac
	High Line		$V_{IN,AC-stop}$	-	-	170	Vac
Input DC Undervoltage Lockout Voltage			$V_{IN,DC-stop}$	-	-	170	Vdc
Maximum Input Current ($I_O = I_{O,max}$, $I_{SB} = I_{SB,max}$)	$V_{IN,AC} = 100Vac$ $V_{IN,AC} = 180Vac$		$I_{IN,max}$	-	-	16.0 16.0	A
No Load Input Power ($V_O = On$, $I_O = 0A$, $I_{SB} = 0A$)	All		$P_{IN,no-load}$	-	-	6	W
Harmonic Line Currents	All	THD	Per EN / IEC 61000-3-2				
Input iTHD	$V_{IN,AC} = 230Vac$ $I_O = 50$ to $100\%I_{O,max}$	iTHD	-	-	5	%	
Power Factor	$I_O > 20\%I_{O,max}$	PF	0.90	-	-		
Startup Surge Current (Inrush) @ 25°C	$V_{IN,AC} = 264Vac$	$I_{IN,surge}$	-	-	45	Apk	
Input Fuse	Internal, L 5x20mm, Quick Acting 20A, 420Vdc		-	-	20	A	
Leakage Current to Earth Ground	$V_{IN,AC} = 264Vac$ $f_{IN,AC} = 60Hz$ UL1950 Measurement Method		-	-	0.57	mA	
Hold-up Time	$I_O = 20\%I_{O,max}$		10	-	-	mSec	
Operating Efficiency @ 25°C	$V_{IN,AC} = 230Vac$ $f_{IN,AC} = 50Hz$ $I_O = 10\%I_{O,max}$ $I_O = 20\%I_{O,max}$ $I_O = 50\%I_{O,max}$ $I_O = 100\%I_{O,max}$	η	89	-	-	%	
			93	-	-	%	
			94	-	-	%	
			94	-	-	%	
			91.5	-	-	%	

ELECTRICAL SPECIFICATIONS

Output Specifications

Table 3. Output Specifications						
Parameter	Condition	Symbol	Min	Typ	Max	Unit
Factory Set Voltage	$V_{IN,AC} = 230Vac$ $I_O = 50\%I_{O,max}$	V_O	12.175	12.20	12.225	Vdc
		V_{SB}	11.95	12.00	12.05	Vdc
Output Regulation	Inclusive of set-point, temperature change, warm-up drift and dynamic load	V_O	11.60	12.20	12.90	Vdc
		V_{SB}	11.40	12.00	12.60	Vdc
Output Ripple, pk-pk	Measure with a 0.1 μ F ceramic capacitor in parallel with a 10 μ F tantalum capacitor, 10 to 20MHz bandwidth	V_O	-	-	180	mV _{PK-PK}
		V_{SB}	-	-	120	mV _{PK-PK}
Output Current ¹	$V_{IN,AC} = 90 - 140Vac$ $V_{IN,AC} = 180 - 264Vac$	I_O	-	-	114.75 196.72	A
	All	I_{SB}	0.1	-	3.5	A
Main Output Current Share Accuracy ²	10% to 100% $I_{O,max}$ $I_O < 10\%I_{O,max}$	% I_O	-	-	8 10	%
Number of Parallel Units	Main output current share connected		-	-	4	Units
Load Capacitance	Turn-on / Turn-off	C_O	-	-	38000	μ F
		C_{SB}	-	-	4700	μ F
Main Output Dynamic Response ³ Peak Deviation	1A min with 18A step, or 8A min with 40A step, or 10A min with 50% I_O step; slew rate = 0.5A/ms; 4000 μ F output cap.	V_O	11.6	-	12.9	V
Main Output Long Term Stability Max change over 24 hours	After thermal equilibrium (30mins) $V_{IN,AC} = 100 / 200Vac$	V_O	-	-	0.5	$\pm\%V_O$
System Stability	Phase Margin Gain Margin		-	45	-	\emptyset
			-	-	-6	dB

Note 1 - 1A minimum current for transient load response testing only. Unit is designed to operate and be within output regulation range at zero load.

Note 2 - The current sharing function start when the total system load has reached 7% of the power supply rating.

Note 3 - 1A minimum current for dynamic response, dynamic load frequency is from 50Hz to 10kHz.

ELECTRICAL SPECIFICATIONS

System Timing Specifications

Table 4. System Timing Specifications					
Label	Parameter	Min	Typ	Max	Unit
T1	Delay from AC being applied to V_{SB} being within regulation.	20	-	2000	mSec
T2 ¹	Delay from standby output to ACOK assertion.	-	-	20	mSec
T3	Delay from standby output to main output voltage being within regulation.	-	-	350	mSec
T4	Delay from AC being applied to main output being within regulation.	-	-	2300	mSec
T5	Delay from output voltages within regulation limits to PWR_GOOD / PWOK assertion.	100	-	500	mSec
T6	Delay from loss of AC to de-assertion of ACOK.	-	-	7	mSec
T7	Delay from loss of AC to de-assertion of PWR_GOOD / PWOK.	10	-	-	mSec
T8	Delay from loss of AC to main output being within regulation.	11	-	-	mSec
T9 ²	Delay from loss of AC to standby output being within regulation.	150	-	-	mSec
T10	Delay from de-assertion of PWOK to output falling out of regulation.	1	-	-	mSec
T11	Delay from PS_ON_L assertion to output being within regulation.	-	-	350	mSec

Note 1 - ACOK can assert earlier than the standby output.

Note 2 - Measured with standby output loaded at 1A, no load at main output.

ELECTRICAL SPECIFICATIONS

System Timing Diagram

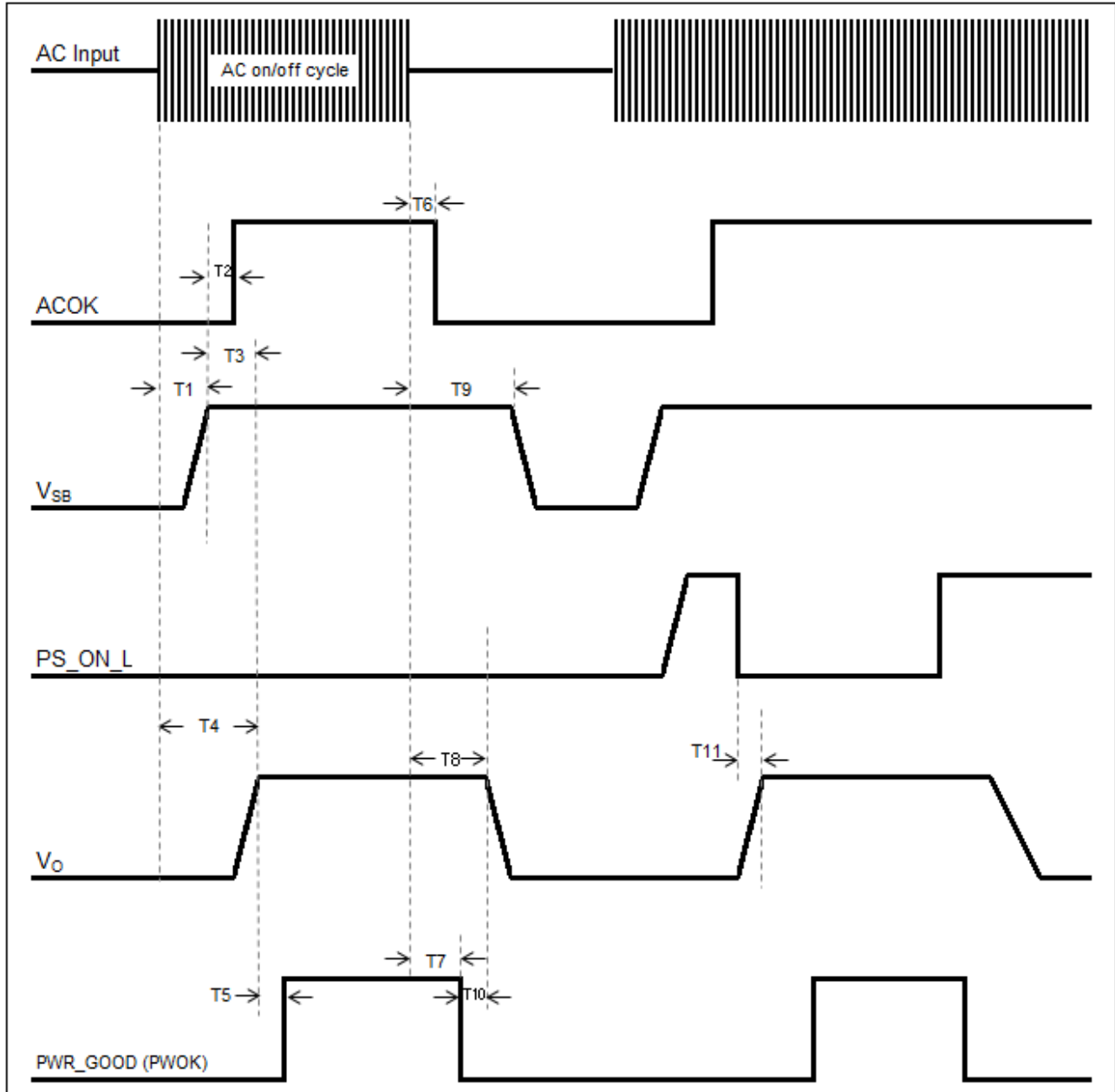

ELECTRICAL SPECIFICATIONS

DS2400SPE-3 Performance Curves



Figure 1: DS2400SPE-3 Turn-On Delay via AC Mains
 Vin = 90Vac Load: $I_o = 114.8A$ $I_{SB} = 3.5A$
 Ch 1: AC Mains Ch 2: V_{SB} Ch 3: V_o Ch 4: PWOK



Figure 2: DS2400SPE-3 Turn-On Delay via PSOn
 Vin = 90Vac Load: $I_o = 114.8A$ $I_{SB} = 3.5A$
 Ch 1: AC Mains Ch 2: PSOn Ch 3: V_o Ch 4: PWOK

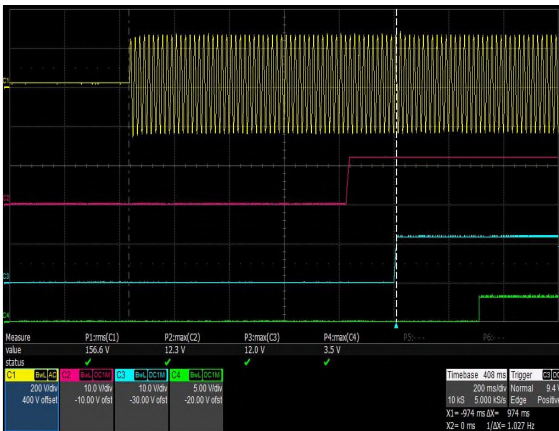

Figure 3: DS2400SPE-3 Turn-on Delay via AC Mains
 Vin = 180Vac Load: $I_o = 196.7A$ $I_{SB} = 3.5A$
 Ch 1: AC Mains Ch 2: V_{SB} Ch 3: V_o Ch 4: PWOK

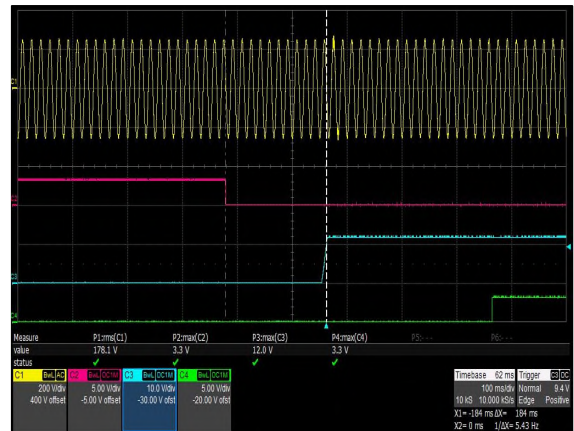

Figure 4: DS2400SPE-3 Turn-on Delay via PSOn
 Vin = 180Vac Load: $I_o = 196.7A$ $I_{SB} = 3.5A$
 Ch 1: AC Mains Ch 2: V_{SB} Ch 3: V_o Ch 4: PWOK

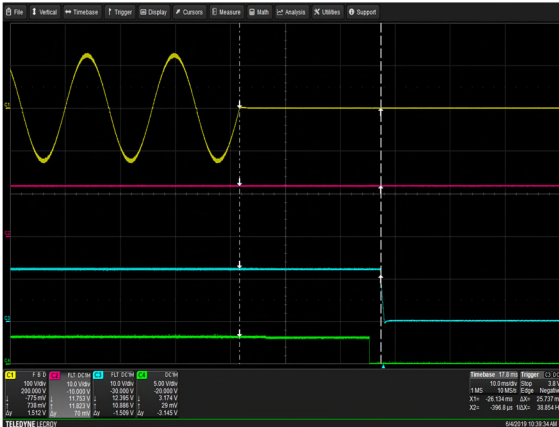

Figure 5: DS2400SPE-3 Hold-up Time
 Vin = 90Vac Load: $I_o = 114.75A$ $I_{SB} = 3.5A$
 Ch 1: AC Mains Ch 2: V_{SB} Ch 3: V_o Ch 4: PWOK

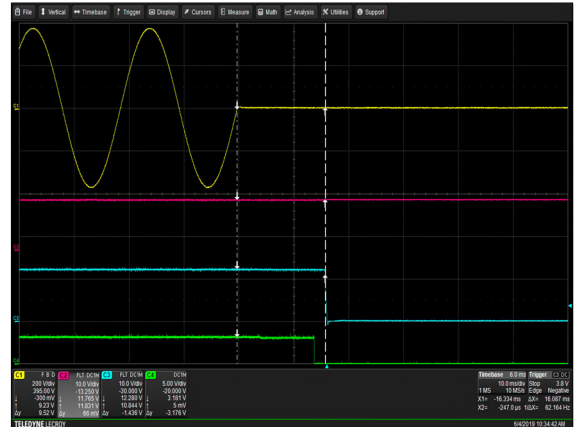

Figure 6: DS2400SPE-3 Hold-up Time
 Vin = 264Vac Load: $I_o = 196.7A$ $I_{SB} = 3.5A$
 Ch 1: AC Mains Ch 2: V_{SB} Ch 3: V_o Ch 4: PWOK

ELECTRICAL SPECIFICATIONS

DS2400SPE-3 Performance Curves

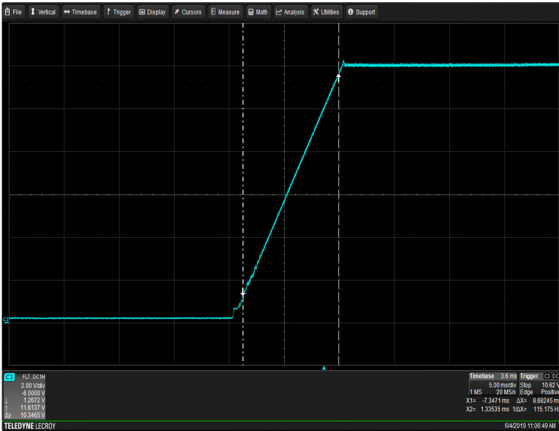

Figure 7: DS2400SPE-3 Output Voltage Startup Characteristic
 $V_{in} = 90V_{ac}$ Load: $I_o = 114.8A$ $I_{SB} = 3.5A$
 Ch 3: V_o

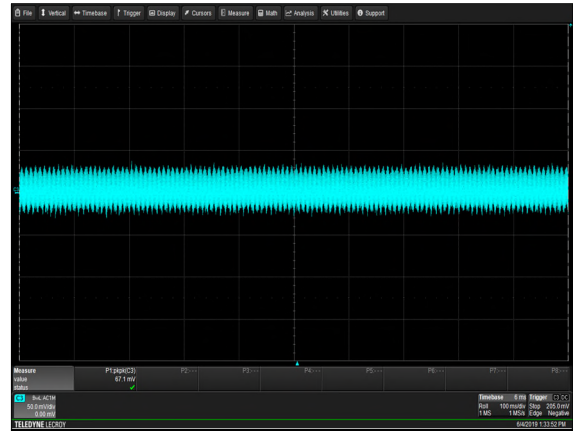

Figure 8: DS2400SPE-3 Ripple and Noise Measurement
 $V_{in} = 115V_{ac}$ Load: $I_o = 114.8A$ $I_{SB} = 3.5A$
 Ch 3: V_o



Figure 9: DS2400SPE-3 Turn Off Characteristic via PSON
 $V_{in} = 90V_{ac}$ Load: $I_o = 114.8A$ $I_{SB} = 3.5A$
 Ch 2: PSON Ch 3: V_o Ch 4: PWOK

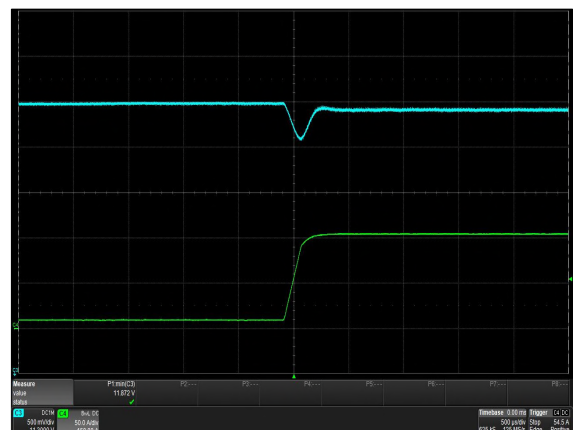

Figure 10: DS2400SPE-3 Transient Response - V_o Deviation
 40% to 100% load change 0.5A/ μs slew rate $V_{in} = 230V_{ac}$
 Ch 3: V_o Ch 4: I_o

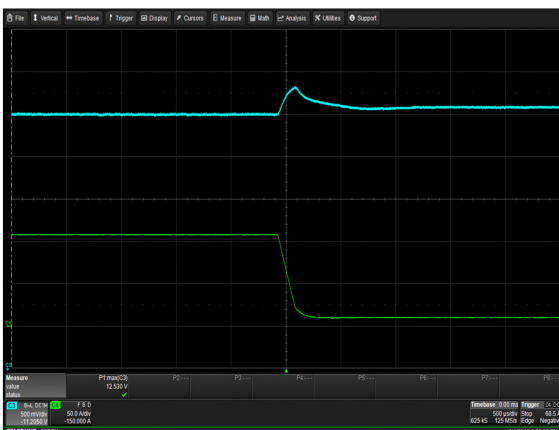

Figure 11: DS2400SPE-3 Transient Response - V_o Deviation
 100% to 40% load change 0.5A/ μs slew rate $V_{in} = 230V_{ac}$
 Ch 3: V_o Ch 4: I_o

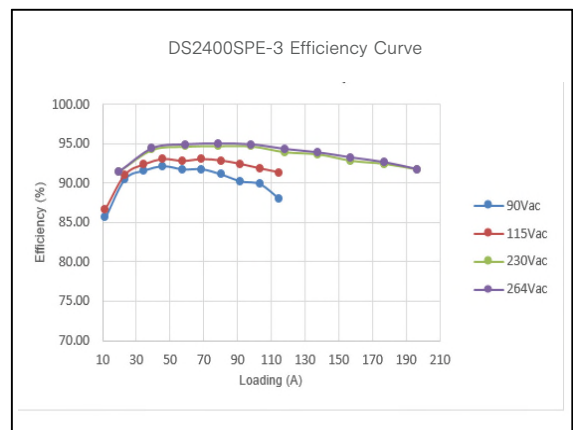

Figure 12: DS2400SPE-3 Efficiency Curve @ 25°C
 Loading: $I_{o,max}$ increment to 114.75A (90/115Vac) and 196.7A (230/264Vac), $I_{o,min} = 10\%I_{o,max}$ increment to 3.5A

ELECTRICAL SPECIFICATIONS

Protection Function Specifications

Input Fuse

DS2400SPE series power supply is equipped with an internal non user serviceable 20A @ 420Vac/Vdc fuse for fault protection on L line input.

Over Voltage / Under Voltage Protection (OVP / UVP)

The main and standby output is protected against over-voltage according to the limits set in below table. When the main output / standby OVP circuit is activated, the power supply will latch off, require PS_ON_L or the input power to be recycled manually to reset the power supply after the fault has been removed.

The power supply main output will shut down if it drops to under-voltage limits below.

OVP

Parameter	Min	Nom	Max	Unit	Protection Mode
V _O Output Overvoltage	13.5	/	14.5	V	Latch
V _{SB} Output Overvoltage	13.5	/	14.5	V	Auto-retry

UVP

Parameter	Min	Nom	Max	Unit	Protection Mode
V _O Output Overvoltage	/	/	9.6	V	Latch
V _{SB} Output Overvoltage	10.0	/	10.5	V	Auto-retry

Over Temperature Protection (OTP)

The power supply is internally protected against over temperature conditions. When the OTP limit is reached, all outputs, except standby, will shut down and will remain off until the over temperature condition no longer exists.

There is hysteresis point between the OTP threshold and the recovery point to ensure there is no frequent on-off cycling of the outputs. Upon reaching the temperature recovery point, all outputs will auto-recover.

Any OTP fault will be reported in the PMBus status flag.

ELECTRICAL SPECIFICATIONS

Over Current Protection (OCP)

The DS2400SPE series power supply main output is internally protected against output overload or short circuit applied to its output. If the over-current is not more than 120% and does not last for more than 55ms, the power supply continues to operate. Latch occurs when the over-current exceeds the conditions mentioned. Any over-current above 170% (+/-10% tolerance) causes the power supply to latch immediately within 10ms. The latched state requires PS_ON_L or the input power to be recycled to reset the power supply after the fault has been removed. A fault in the main output does not cause the standby output to shut down.

The standby has an OCP limit from 110% to 150% and auto-retry when the overload is removed. A fault in the standby output shuts down other outputs and auto-recovers when the overload on the standby is removed.

Parameter	Min	Nom	Max	Protection Mode
V _O Output Overcurrent Protection	120%	/	170%	Latch if the overload >55mS
V _O Output Overcurrent Protection	170%	/	/	Latch immediately
V _{SB} Output Overcurrent Protection	110%	/	150%	Shutdown and auto-retry

Short Circuit Protection (SCP)

The DS2400SPE series power supply protects against a short circuit, which is defined as an impedance of 0.06ohm or less, applied to any output during start-up or while running. When the main output is shorted, the power supply latches off immediately. The latched state requires AC power / PS_ON_L recycling to restart the power supply.

When the standby output is shorted, the output goes into “hiccup mode”. When the standby output attempts to restart, the maximum peak current from the standby output is less than 10A. The maximum average current, taking into account the “hiccup” duty cycle, does not exceed the rated output current of the standby.

MECHANICAL SPECIFICATIONS

Mechanical Outlines (unit: mm)

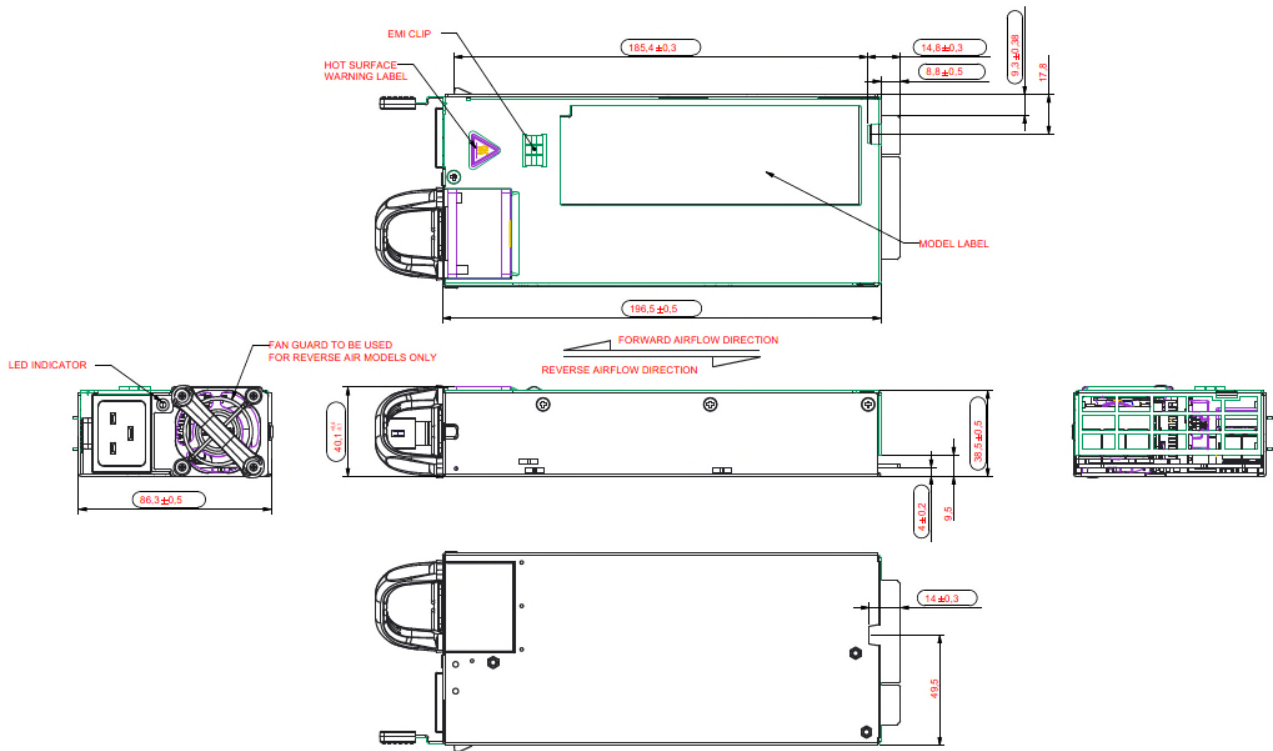

MECHANICAL SPECIFICATIONS

Connector Definitions

AC Input Connector

Pin 1 – Line

Pin 2 – Neutral

Pin 3 – Earth Ground

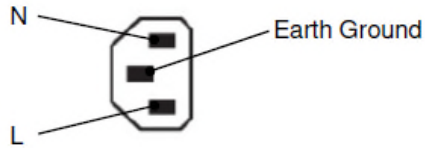

Output Connector - Power Blades

P1-P8 – Main Output (V_O)

P9-P18 – Main Output Return

P19-P20 – Standby Output (V_{SB})

P21-P28 – Main Output Return

P29-P36 – Main Output (V_O)

Power Supply Output Card Edge (Bottom Side)

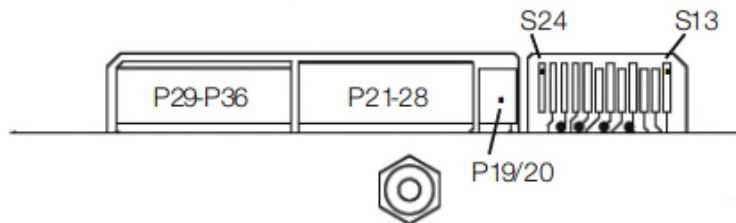

Output Connector - Control Signals

S1 – PS_PRESENT

S2 & S3 – RESERVED

S4 – PWR_GOOD (PWOK)

S5 – ACOK (AC Input Present)

S6 – RETURN

S7 – I_SHARE

S8 – RESERVED

S9 – PS_INTERRUPT_L / ALERT

S10 – RETURN

S11 & S12 – RESERVED

S13 – PS_ON_L

S14 – PSKILL_H

S15 – RESERVED

S16 – RETURN

S17 – SDA

S18 – RETURN

S19 – SCL

S20 – RETURN

S21 – REMOTE SENSE-

S22 – RETURN

S23 – REMOTE SENSE+

S24 – RESERVED

Power Supply Output Card Edge (Top Side)

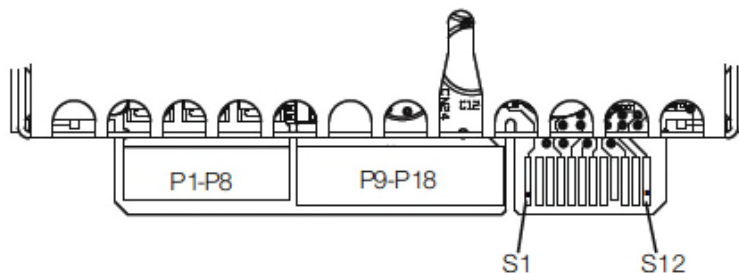

MECHANICAL SPECIFICATIONS

Power / Signal Mating Connectors and Pin Types

Table 5. Mating Connectors for DS2400SPE Series		
Reference	On Power Supply	Mating Connector or Equivalent
AC Input Connector	IEC320-C20	IEC320-C19
Output Connector	Card-edge	FCI 10107844-002LF or any equivalent

MECHANICAL SPECIFICATIONS

LED Indicator Definitions

LED INDICATOR

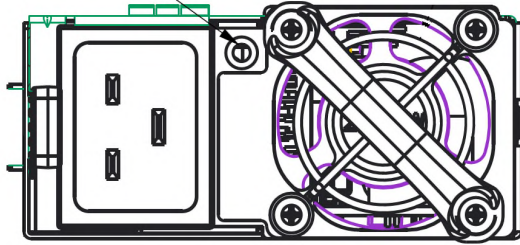

One bi-color (green/amber) LED at the power supply front provides the status signal. The status LED conditions are shown on the below table.

Conditions	LED Status
Output ON and OK.	Solid Green
No AC power to all power supplies.	Off
Standby mode (PS_ON_L = High)	Blinking Green
Power supply failure (OCP,OVP,OTP, etc.)	Blinking Amber

MECHANICAL SPECIFICATIONS

Weight

The DS2400SPE series power supply weight is 1160g/2.56lbs.

ENVIRONMENTAL SPECIFICATIONS

EMC Immunity

DS2400SPE series power supply is designed to meet the following EMC immunity specifications.

Table 6. Environmental Specifications	
Standard	Description
EN55032/FCC/CFR47	Radiated Emissions, 30M - 1GHz, Class A
EN55032/FCC/CFR47	Conducted Emissions, 150K - 30MHz, Class A
IEC/EN61000-3-2	Harmonics - AC supply <16A per phase
IEC/EN61000-3-3	Voltage Fluctuations - AC supply <16A per phase
IEC/EN61000-4-2	Electromagnetic Compatibility (EMC) - Testing and measurement techniques - Electrostatic discharge immunity test: 15KV air, 8KV contact discharge. Performance - Criteria B
IEC/EN61000-4-3	Electromagnetic Compatibility (EMC) - Testing and measurement techniques - Radiated, radio-frequency, electromagnetic field immunity test: 10V/m. Performance - Criteria A
IEC/EN61000-4-4	Electromagnetic Compatibility (EMC) - Testing and measurement techniques - Electrical fast transient/burst immunity test: +/-2KV for AC power port. Performance - Criteria B +/- 0.5KV for AC power port. Performance - Criteria A
IEC/EN61000-4-5	Electromagnetic Compatibility (EMC) - Testing and measurement techniques - Surge test: +/-2KV common mode and +/-1KV differential mode for AC ports. Performance - Criteria A
IEC/EN61000-4-6	Electromagnetic Compatibility (EMC) - Testing and measurement techniques - Conducted Immunity 10Vrms. Performance - Criteria A.
EN61000-4-11	Electromagnetic Compatibility (EMC) - Testing and measurement techniques - Voltage dips and interruptions: Criteria B: >95% reduction for 10ms; Criteria B: >30% reduction for 500mS, or Criteria C: >95% reduction for 500mS.

Notes: Performance Criteria as defined by EN300386.

Performance Criteria A: The apparatus shall continue to operate as intended after the test. No degradation of performance or loss of function is allowed below specified performance level during intended use of operation.

Performance Criteria B: The apparatus shall continue to operate as intended after the test. No degradation of performance or loss of function is allowed below specified performance level during intended use of operation. Degradation of performance is allowed during the exposure to an electromagnetic phenomenon but no change of actual operating state is allowed.

Performance Criteria C: Temporary loss of function is allowed, provided the function is self-recoverable or can be restored by the operation of the controls.

ENVIRONMENTAL SPECIFICATIONS

Safety Certifications

The DS2400SPE series power supply is intended for inclusion in other equipment and the installer must ensure that it is in compliance with all the requirements of the end application. This product is only for inclusion by professional installers within other equipment and must not be operated as a stand alone product.

Table 7. Safety Certifications for DS2400SPE Series Power Supply		
Standard	Agency	Description
UL/cUL60950 (UL Recognized)	UL + CUL	US and Canada Requirements
DEMKO+CB Report EN60950		All CENELEC Countries
CE Mark		European Requirements
UKCA	UKCA	UK Requirements
CHINA CQC Approval		China Requirements
KC		Korea Certification
EAC		Russia Requirements
BIS		India Requirements
BSMI		Taiwan Requirements

ENVIRONMENTAL SPECIFICATIONS

EMI Emissions

The DS2400SPE series power supply has been designed to comply with the Class A limits of EMI requirements of FCC CFR 47 Part 15 Subpart B and the limits specified in CISPR22 / EN55032.

Conducted Emissions

The applicable standard for conducted emissions is EN55032 (FCC Part 15). Conducted noise can appear as both differential mode and common mode noise currents. Differential mode noise is measured between the two input lines, with the major components occurring at the supply fundamental switching frequency and its harmonics. Common mode noise, a contributor to both radiated emissions and input conducted emissions, is measured between the input lines and system ground and can be broadband in nature.

Conducted Emission at AC power

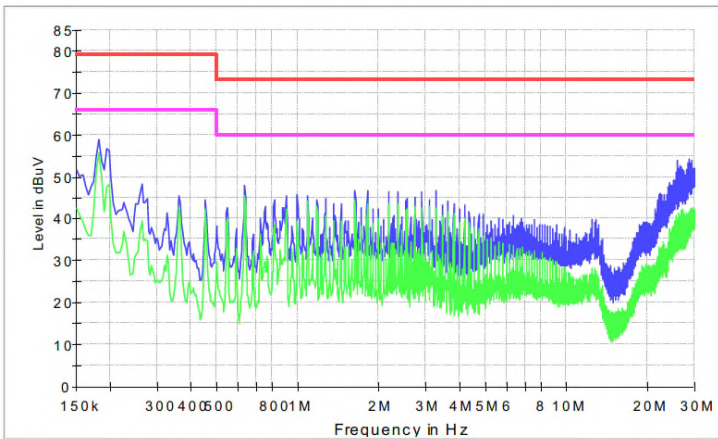

The DS2400SPE series power supply has internal EMI filters to ensure the convertor’s conducted EMI levels comply with EN55032 (FCC Part 15) Class A limits. The EMI measurements are performed with resistive loads at maximum rated loading.

Sample of EN55032 conducted EMI measurement at 230Vac / 50Hz input.

Note: Red Line refers to Artesyn Quasi Peak margin, which is 6dB below the CISPR international limit. Pink Line refers to the Quasi Average margin, which is 6dB below the CISPR international limit.

Conducted EMI emissions specifications of the DS2400SPE series power supply:

Parameter	Model	Symbol	Min	Typ	Max	Unit
FCC Part 15, class A	All	Margin	6	-	-	dB
CISPR 32 (EN55032), class A	All	Margin	6	-	-	dB

ENVIRONMENTAL SPECIFICATIONS

Radiated Emissions

Unlike conducted EMI, radiated EMI performance in a system environment may differ drastically from that in a stand-alone power supply. The shielding effect provided by the system enclosure may bring the EMI level from Class A to Class B. It is thus recommended that radiated EMI be evaluated in a system environment. The applicable standard is EN55032 Class A (FCC Part 15). Testing AC-DC converters as a stand-alone component to the exact requirements of EN55032 can be difficult because the standard calls for 1m lead to be attached to the input and outputs and aligned such as to maximize the disturbance. In such a set-up, it is possible to form a perfect dipole antenna that very few AC-DC converters could pass. However, the standard also states that an attempt will be made to maximize the disturbance consistent with the typical application by varying the configuration of the test sample.

ENVIRONMENTAL SPECIFICATIONS

Operating Temperature

The DS2400SPE series power supply ambient operating limits are shown in the table below.

Table 8. Operating Temperature Requirements (Air Inlet Temperature)						
Model	Conditions	Output Power	Operating Temperature		Altitude	System Back Pressure (in H ₂ O)
			Min	Max		
DS2400SPE-3	V _{IN,AC} = 90-140Vac V _{IN,AC} = 180-264Vac	1400W 2400W	0°C	50°C	950m/3100ft	0.0
	V _{IN,AC} = 90-140Vac V _{IN,AC} = 180-264Vac	1400W 2200W	0°C	50°C	3050m/10000ft	0.0
	V _{IN,AC} = 90-140Vac V _{IN,AC} = 180-264Vac	1200W 1800W	0°C	60°C	3050m/10000ft	0.0
	V _{IN,AC} = 90-140Vac V _{IN,AC} = 180-264Vac	1350W 2000W	0°C	50°C	3050m/10000ft	0.5
DS2400SPE-3-001	V _{IN,AC} = 90-140Vac V _{IN,AC} = 180-264Vac	1400W 2200W	0°C	40°C	950m/3100ft	0.0
	V _{IN,AC} = 90-140Vac V _{IN,AC} = 180-264Vac	1400W 2400W	0°C	40°C	Sea Level	0.0
	V _{IN,AC} = 90-140Vac V _{IN,AC} = 180-264Vac	1400W 1900W	0°C	40°C	3050m/10000ft	0.0
	V _{IN,AC} = 90-140Vac V _{IN,AC} = 180-264Vac	1200W 1700W	0°C	50°C	3050m/10000ft	0.0

ENVIRONMENTAL SPECIFICATIONS

Storage and Shipping Temperature

The DS2400SPE series power supply can be stored or shipped at temperatures between -40°C to +70°C.

Altitude

The DS2400SPE series power supply will operate within specifications at altitudes up to 10,000 feet above sea level. The power supply will not be damaged when stored at altitudes up to 50,000 feet above sea level.

Humidity

The CSU2400AP series power supply can operate within specifications when subjected to a relative humidity from 5% to 95% non-condensing. The power supply can be stored in a relative humidity from 5% to 95% non-condensing.

Vibration

The DS2400SPE series power supply will pass the following vibration specifications:

Non-Operating Random Vibration

Acceleration	3.13	gRMS	
Frequency Range	5 - 500	Hz	
Duration	15	Mins	
Direction	6 mutually perpendicular axis		
PSD Profile	FREQ (Hz)	SLOPE (db/oct)	PSD (g ² /Hz)
	5	/	0.000595
	50	/	0.03
	500	/	0.0585

Operating Random Vibration

Acceleration	0.63	gRMS	
Frequency Range	5 - 500	Hz	
Duration	10	Mins	
Direction	3 mutually perpendicular axis		
PSD Profile	FREQ (Hz)	SLOPE (db/oct)	PSD (g ² /Hz)
	5	/	0.000882
	50	/	0.000882
	500	/	0.0004332

ENVIRONMENTAL SPECIFICATIONS

Shock

The DS2400SPE series power supply will pass the following vibration specifications:

Non-Operating Half-Sine Shock

Acceleration	40	G
Duration	15	in. / sec
Pulse	Half-sine	
Number of Shock	3 shocks in each of 6 faces	

Operating Half-Sine Shock

Acceleration	30	G
Duration	11	mSec
Pulse	Half-sine	
Number of Shock	3 shocks in each of 6 faces	

POWER AND CONTROL SIGNAL DESCRIPTIONS

AC Input Connector

This connector supplies the AC Mains to the DS2400SPE series power supply.

- Pin 1 – L
- Pin 2 – N
- Pin 3 – Earth Ground

Output Connector – Power Blades

These pins provide the main output for the DS2400SPE series power supply. The Main Output (V_O) and the Main Output Return pins are the positive and negative rails, respectively, of the V_O main output of the DS2400SPE series power supply. The Main Output (V_O) is electrically isolated from the power supply chassis.

- P1-P8 – Main Output (V_O)
- P9-P18 – Main Output Return
- P19-P20 – Standby Output (V_{SB})
- P21-P28 – Main Output Return
- P29-P36 – Main Output (V_O)

Output Connector – Control Signals

The DS2400SPE series power supply contains a 24 pins control signal header providing an analogue control interface, standby power and I²C interface signal connections.

PWR_GOOD (PWOK) - (Pin S4)

A power good signal will be asserted, driven HIGH (>2.0V) by the power supply to indicate that all outputs are valid. If the main output falls below 10.9V for any reason, then this output will be driven LOW (<0.4V). This signal has 1K pull-up resistor connected to standby bus before Oring device inside PSU.

PWOK Signal Electrical Characteristics:

High = OK, Low = Not OK.			
Load (per power supply unit)	Min	Max	Unit
Output High Voltage	2.4	3.6	V
Output Low Voltage	0.0	0.4	V
Output Signal Source Current	-	2	mA
Output Signal Sink Current	-	4	mA
Output Rise and Fall Time (Zero decoupling capacitor)	-	100	uSec

POWER AND CONTROL SIGNAL DESCRIPTIONS

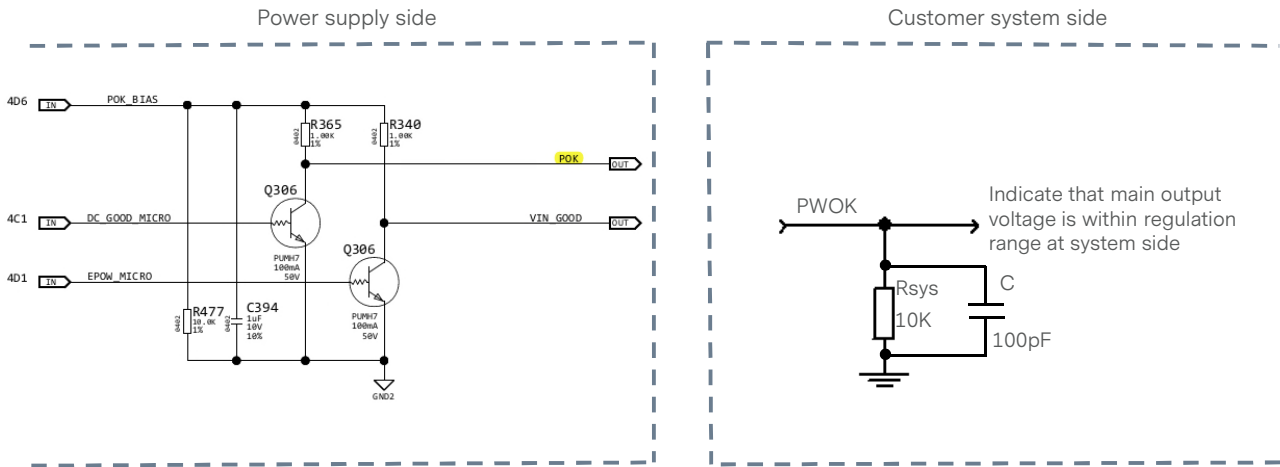

ACOK (AC Input Present) - (Pin S5)

The ACOK is an open collector signal which is normally HIGH (>2.0V) whenever input AC voltage is within allowable limits. This signal will go LOW (<0.4V) within 6ms from loss of AC. Power supply has internal 1Kohm pull-up resistor to internal bias. Additional pull-up on system side may be added but current limited to 0.7mA. Suitable noise filter capacitor connected to standby return line is recommended on system side.

ACOK Signal Electrical Characteristics:

High = OK, Low = Not OK.			
Load (per power supply unit)	Min	Max	Unit
Output High Voltage	2.4	3.6	V
Output Low Voltage	0.0	0.4	V
Output Signal Source Current	-	2	mA
Output Signal Sink Current	-	4	mA
Output Rise and Fall Time (Zero decoupling capacitor)	-	100	uSec

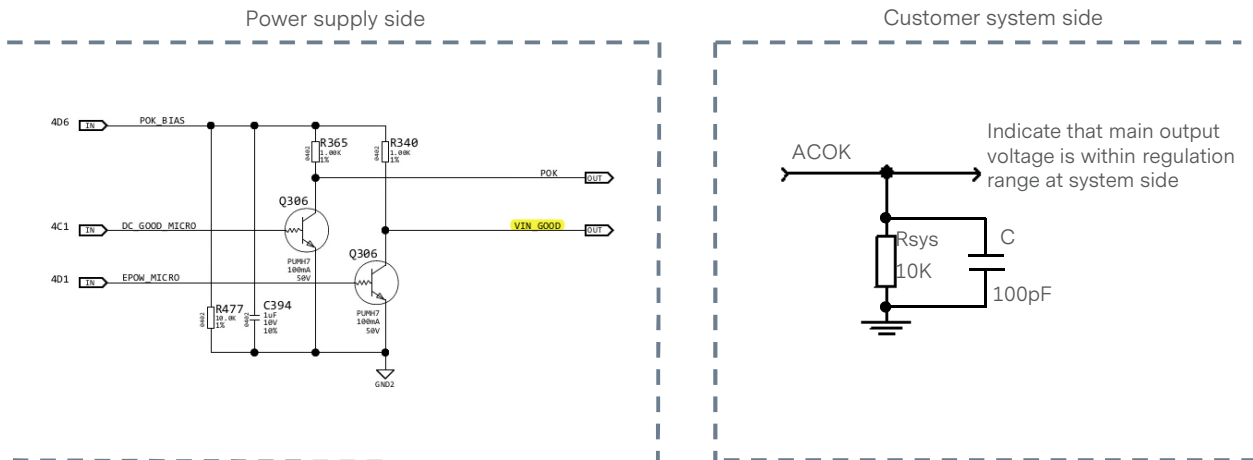

POWER AND CONTROL SIGNAL DESCRIPTIONS

I_SHARE (Current Share Bus) - (Pin S7)

This signal is a bus which will allow two or more power supplies to share the system load current.

This signal will have a voltage which is directly proportional to supplied current, and be represented by $7 \cdot I_{out}/I_{max}$. A linear slope from minimum load to full load is expected. The I_SHARE voltage will be within the voltage range specified in below table. It is capable of sinking 0.4mA and sourcing 4mA.

I_SHARE Signal Accuracy:

Load (per power supply unit)	I_SHARE Signal Voltage (Vdc)		
	Min	Typ	Max
100%	6.912	7.0	7.088
50%	3.412	3.5	3.588
0%	0.000	0.0	0.450

The I_SHARE signal can be disabled by shorting this pin to ground. The main output voltage will stay within regulation limits in this condition.

PS_PRESENT_L - (Pin S9)

This signal pin is grounded inside the power supply. It can be used to sense PSUs seated in the system by using a suitable pull-up to standby bus with a noise filter capacitor connected to standby output return.

PS_PRESENT_L Signal Electrical Characteristics:

High = PSU not present, Low = PSU present.			
Parameter	Min	Max	Unit
Signal Sink Current when LOW	-	4	mA
Signal Sink Current when HIGH	-	50	uA

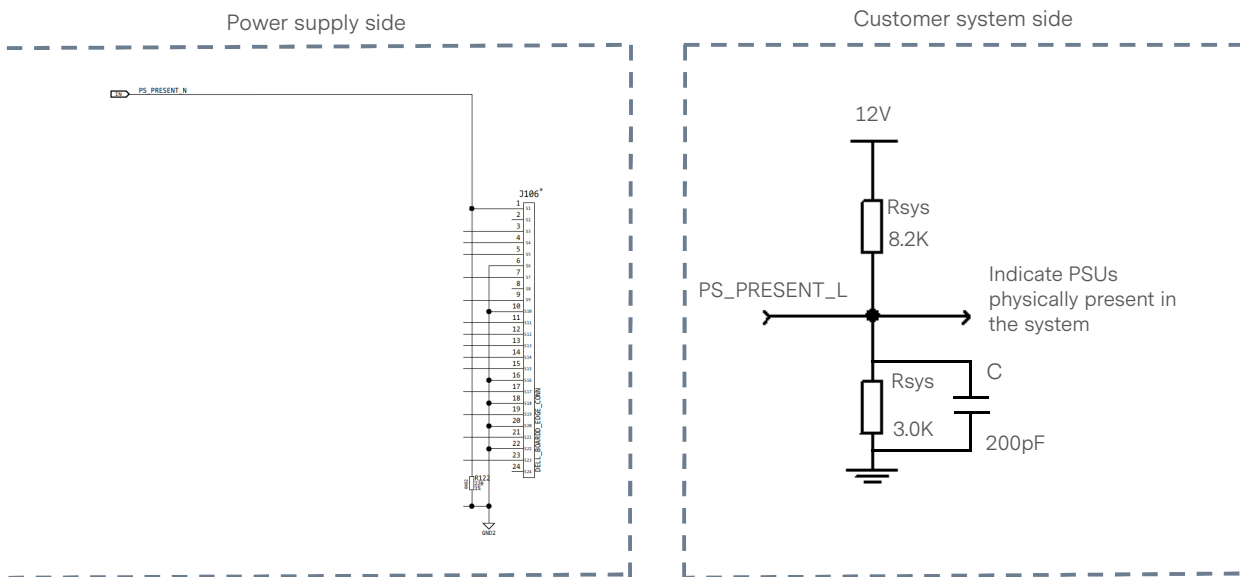

POWER AND CONTROL SIGNAL DESCRIPTIONS

PS_ON_L (Remote On/Off) - (Pin S13)

This signal is active low signal, enables or disables the main output of the power supply. It has 10K internal pull-up resistor, no additional pull-up required by system.

When the signal is pulled low (<0.8V) by the system, the main output will be enabled. The signal can source a maximum of 1mA in this state. Pulling this signal to high (>2.0V) will shutdown the main output. This signal can be pulled high to 5.0V maximum. The standby output is not affected by this signal. This signal is defined by the logic table below.

PS_ON_L Signal Logic Table:

PS_ON_L	PSKILL_H	Main Output State
Low	Low	On
Low	Open	Off
Open	Low	Off
Open	Open	Off

PS_ON_L Signal Electrical Characteristics:

High = PSU Off, Low = PSU On.			
Parameter	Min	Max	Unit
Input High Voltage	2.0	3.6	V
Input Low Voltage	0.0	0.8	V
Source Current when LOW	-	4	mA
Expected Rise and Fall Time (zero decoupling capacitor)	-	500	uSec

This function is supported through PMBus, please refer to section “DS2400SPE Series Support PMBus™ Command List” for more details.

For proper power supply operation, it is recommended to provide separate PS_ON_L signal to each unit using suitable circuit capable to sink 4mA max current when connected in parallel configuration.

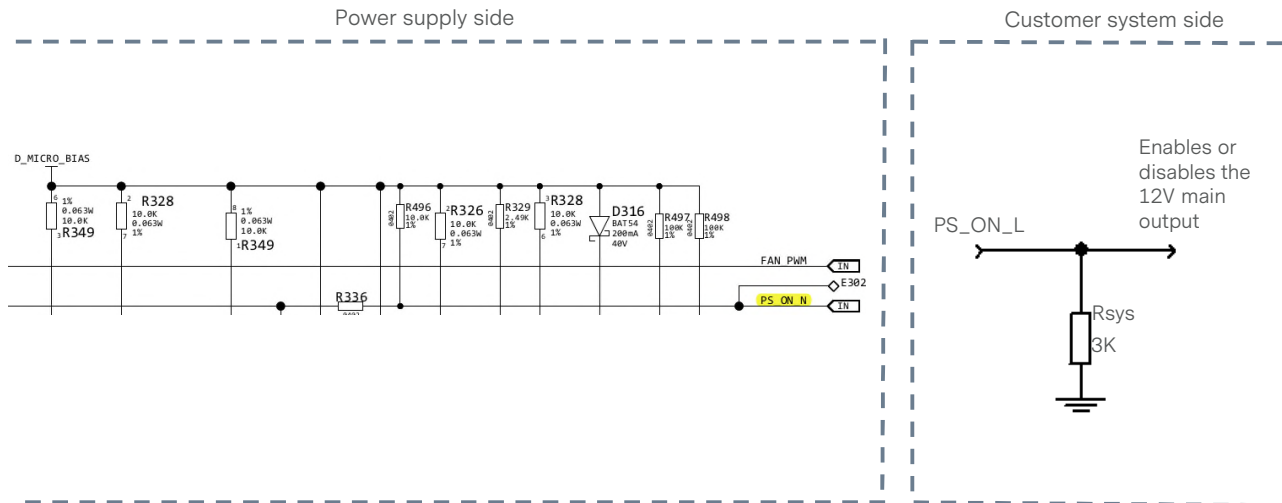

POWER AND CONTROL SIGNAL DESCRIPTIONS

PSKILL_H - (Pin S14)

This signal has the shortest pin in the output connector. It functions as the first break / last mate pin, thus, supports hot-swap capability. This enables or disables the 12.2V main output of the power supply. When this signal is opened by the power supply removal from the system, the main output will immediately shut down.

PSKILL_H Signal Electrical Characteristics:

High = PSU Off, Low = PSU On.			
Parameter	Min	Max	Unit
Input High Voltage	2.0	3.6	V
Input Low Voltage	0.0	0.8	V
Source Current when LOW	-	4	mA
Expected Rise and Fall Time (zero decoupling capacitor)	-	500	uSec

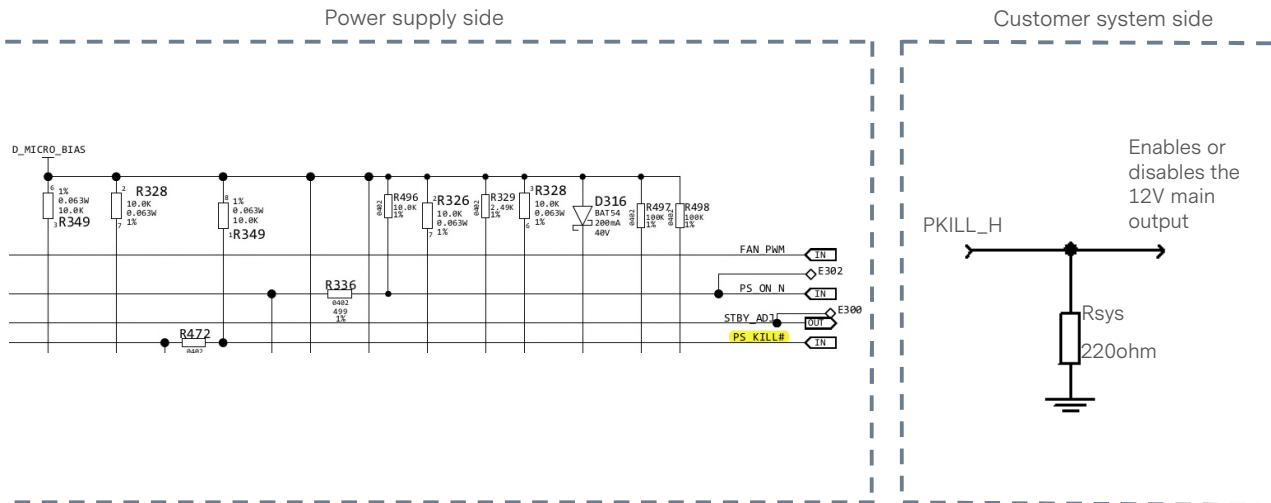

REMOTE SENSE +, REMOTE SENSE - (Pins S21, S23)

The power supply main output is equipped with remote sense on the REMOTE SENSE + and REMOTE SENSE - pins. This remote sense circuit can compensate for a power path drop of 200mV on each sense line. It will not raise the power supply's output voltage to the OVP trip level.

SDA, SCL, and PS_INTERRUPT_L

Please refer to "Communication Bus Descriptions" section.

COMMUNICATION BUS DESCRIPTIONS

I²C Bus Signals

DS2400SPE series power supply contains enhanced monitor and control functions implemented via the I²C bus. The DS2400SPE series I²C functionality (PMBus™ and FRU data) can be accessed via the output connector control signals. The communication bus is powered either by the internal 3.3V supply or from an external power source connected to the standby output (i.e. accessing an unpowered power supply as long as the standby output of another power supply connected in parallel is on).

If units are connected in parallel or in redundant mode, the standby outputs must be connected together in the system. Otherwise, the I²C bus will not work properly when a unit is inserted into the system without the DC source connected.

Note: PMBus™ functionality can be accessed only when the PSU is powered-up. Guaranteed communication I²C speed is 100KHz.

Power Supply Addressing

The DS2400SPE standard power supply has the fixed address: B0h.

PS_INTERRUPT_L - (Pin S9)

PS_INTERRUPT_L is used to send a signal to the system that a fault in the power supply occurred. This signal is normally logic level HIGH. It will go to a LOW logic level when a fault bit has been set in the power supply's status register. To reset the PS_INTERRUPT_L signal back to normal (logic HIGH level), perform one of the following actions - (1) recycle input AC power, (2) toggle PSON signal and (3) issuance of a CLEAR_FAULTS PMBus™ command.

SDA, SCL (I²C Data and Clock Signals) - (Pins S17, S19)

SDA and SCL are bi-directional serial bus lines for communication for PMBus devices in the power supply and the host system. These pins are internally pulled up to internal bias supply with a 100K resistor. These pins are recommended to be pulled-up in the system by an 2.2Kohm resistor to 3.3V and a 200pF decoupling capacitor at the system side.

If units are connected in parallel or redundant mode, the stand-by output must be capable of maintaining supply to the power supply controller such that I²C communication is not lost even without an AC supply in one power supply.

If these pins are pulled up to the stand-by output created from the main output using a step-down, non-isolated DC/DC provided within the end system, the ground of the stand-by output and main output must be connected together.

I²C Bus Communication Interval

The interval between two consecutive I²C communications to the power supply must be at least 15ms to ensure proper monitoring functionality.

I²C Bus Signal Integrity

The noise on the I²C bus (SDA, SCL lines) due to the power supply will be less than 300mV peak-to-peak. This noise measurement should be made with an oscilloscope bandwidth limited to 100MHz. Measurements must be made at the power supply output connector with 10Kohm resistors pulled up to 3.3V source and a decoupling 47pF ceramic capacitors to standby output return.

COMMUNICATION BUS DESCRIPTIONS

I²C Bus Internal Implementation, Pull-ups and Bus Capacitances

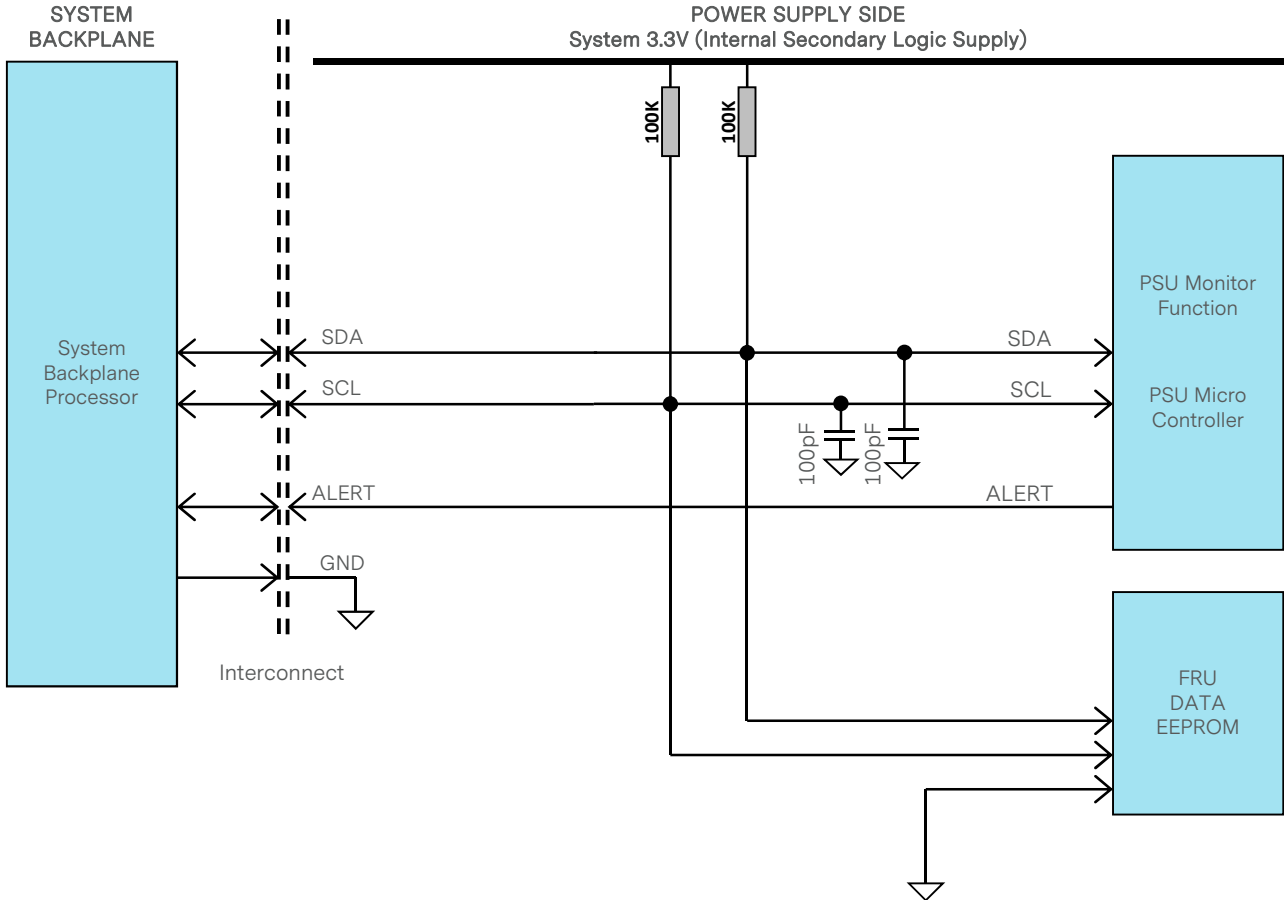

I²C Bus - Recommended external pull-ups

Electrical and interface specifications of I²C signals (referenced to standby output return pin, unless otherwise indicated):

Parameter	Condition	Symbol	Min	Type	Max	Unit
SDA, SCL Internal Pull-up Resistor		R_{int}	-	100	-	Kohm
SDA, SCL Recommended External Bus Capacitance		C_{int}	-	100	-	pF
Recommended External Pull-up Resistor	1 to 4 PSU	R_{ext}	-	2.2	-	Kohm

COMMUNICATION BUS DESCRIPTIONS

Logic Levels

DS2400SPE series power supply I²C communication bus will respond to logic levels as per below:

Logic High: 3.3V nominal (Spec is 2.1V to 5.5V)**

Logic Low: 500mV nominal (Spec is 800mV max)**

**Note: Artesyn 73-769-001 I²C adapter was used.

Timings

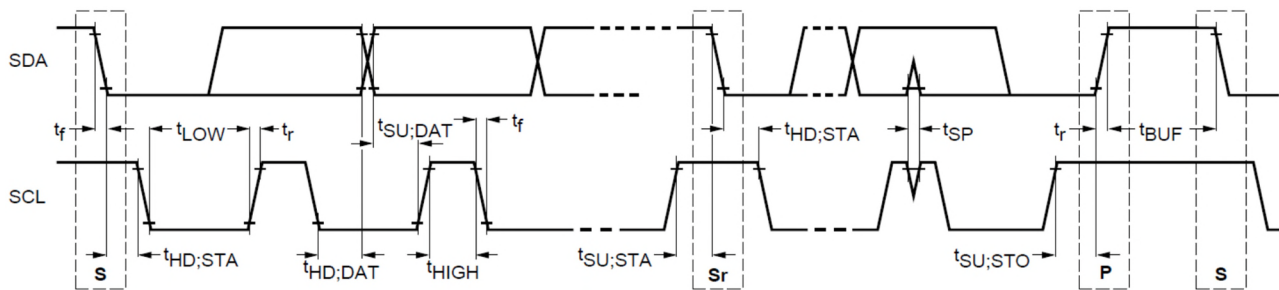

Parameter	Symbol	Standard-Mode Specs		Actual Measured	Unit
		Min	Max		
SCL clock frequency	f_{SCL}	0	100	99.74	KHz
Hold time (repeated) START condition	$t_{HD;STA}$	4.0	-	4.73	uS
LOW period of SCL clock	t_{LOW}	4.7	-	4.91	uS
HIGH period of SCL clock	t_{HIGH}	4.0	50	4.16	uS
Setup time for repeated START condition	$t_{SU;STA}$	4.7	-	4.87	uS
Data hold time	$t_{HD;DAT}$	0	3.45	1.7	uS
Data setup time	$t_{SU;DAT}$	250	-	5029	nS
Rise time	t_r	-	1000	SCL = 916 SDA = 914.4	nS
Fall time	t_f	-	300	SCL = 136.7 SDA = 145.1	nS
Setup time for STOP condition	$t_{SU;STO}$	4.0	-	5.37	uS
Bus free time between a STOP and START condition	t_{BUF}	4.7	-	63.5***	uS

***Note: Artesyn 73-769-001 I²C adapter (USB-to-I2C) and Universal PMBus™ GUI software was used.

COMMUNICATION BUS DESCRIPTIONS

I²C Clock Synchronization

The DS2400SPE series power supply applies clock stretching. An addressed slave power supply holds the clock line (SCL) low after receiving (or sending) a byte, indicating that it is not yet ready to process more data. The system master that is communicating with the power supply will attempt to raise the clock to transfer the next bit but must verify that the clock line was actually raised. If the power supply is clock stretching, the clock line will still be low (because the connections are open-drain).

The maximum time-out condition for clock stretching for DS2400SPE series is 30 milliseconds.

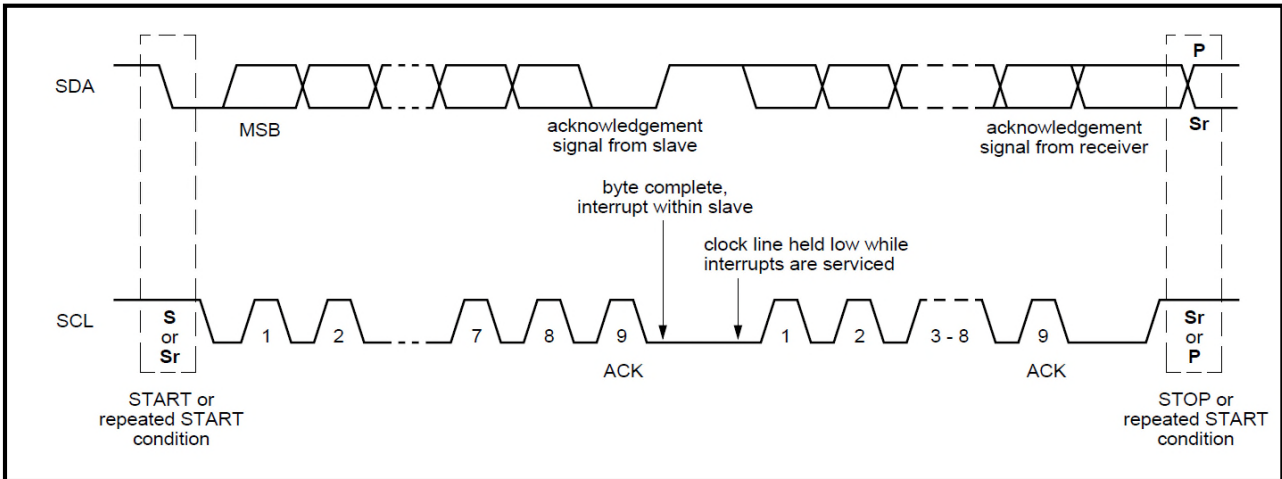

COMMUNICATION BUS DESCRIPTIONS

FRU (EEPROM) Data

The FRU (Field Replaceable Unit) data format is compliant with the Intel IPMI v1.0 specification.

The DS2400SPE series uses 1 page of EEPROM for FRU purpose. A page of EEPROM contains up to 256 byte-sized data locations.

Where:	OFFSET	-The OFFSET denotes the address in decimal format of a particular data byte within DS2400SPE series EEPROM.
	VALUE	-The VALUE details data written to a particular memory location of the EEPROM.
	DEFINITION	-The contents DEFINITION refers to the definition of a particular data byte.

DS2400SPE series FRU (EEPROM) Data:

OFFSET		DEFINITION (REMARKS)	SPEC VALUE	
(DEC)	(HEX)		(DEC)	(HEX)
COMMON HEADER, 8 BYTES				
0	00	FORMAT VERSION NUMBER (Common header) 7:4 - Reserved, write as 0000b 3:0 - Format version number = 1h for this specification	1	01
1	01	INTERNAL USE AREA OFFSET (Not required, do not reserve)	22	16
2	02	CHASSIS INFO AREA OFFSET (Not required, do not reserve)	1	01
3	03	BOARD INFO AREA OFFSET (Not required, do not reserve)	0	00
4	04	PRODUCT INFO AREA OFFSET	4	04
5	05	MULTI RECORD AREA OFFSET	13	0D
6	06	PAD (Not required, do not reserve)	0	00
7	07	ZERO CHECK SUM (256 - (Sum of bytes 0 to 6))	215	D7
8	08	FORMAT VERSION NUMBER 7:4 - Reserved, write as 0000b 3:0 - Format Version Number = 1h for this specification	1	01
9	09	CHASSIS INFO AREA LENGTH in multiple of 8 bytes	3	03
10	0A	CHASSIS TYPE (Default value is 0.)	0	00
11	0B	CHASSIS PART NUMBER Type/Length CAh (if used) Type = "ASCII+LATIN1" = (11)b length = 10 bytes = (001010)b	202	CA
12	0C	CHASSIS PART NUMBER BYTES (Default value is 0.)	0	00
13	0D		0	00
14	0E		0	00
15	0F		0	00
16	10		0	00
17	11		0	00
18	12		0	00
19	13		0	00
20	14		0	00
21	15		0	00
22	16	CHASSIS SERIAL NUMBER Type/Length CFH (if used) Type = "ASCII+LATIN1" = (11)b length = 15 bytes = (001111)b	199	C7
23	17	CHASSIS SERIAL NUMBER BYTES , default value is 0.	0	00
24	18		0	00
25	19		0	00
26	1A		0	00
27	1B		0	00
28	1C		0	00
29	1D		0	00
30	1E	End Tag (Default value is 0.)	193	C1
31	1F	Zero Check Sum (From 8d to 30d if used)	170	AA

COMMUNICATION BUS DESCRIPTIONS

DS2400SPE series FRU (EEPROM) Data:

OFFSET		DEFINITION (REMARKS)	SPEC VALUE	
(DEC)	(HEX)		(DEC)	(HEX)
PRODUCT INFORMATION AREA, 72 BYTES				
32	20	FORMAT VERSION NUMBER (Product Info Area) 7:4 - Reserved, write as 0000b 3:0 - Format Version Number = 1h for this specification	1	01
33	21	PRODUCT INFO AREA LENGTH (In multiples of 8 bytes)	9	09
34	22	Language	25	19
35	23	Manufacturer Name Type/Length , 7-byte allocation = C7H	199	C7
36	24	MANUFACTURER'S NAME 7 bytes sequence "A" = 41h "R" = 52h "T" = 54h "E" = 55h "S" = 53h "Y" = 59h "N" = 4Eh	65	41
37	25		82	52
38	26		84	54
39	27		69	45
40	28		83	53
41	29		89	59
42	2A		78	4E
43	2B	Product Name Type/Length, 15-byte allocation = CFH	207	CF
44	2C	Product Name , 12 bytes sequence "D" = 44H "S" = 53H "2" = 32H "4" = 34H "0" = 30H "O" = 30H "S" = 53H "P" = 50H "E" = 45H "_" = 2DH "3" = 33H	68	44
45	2D		83	53
46	2E		50	32
47	2F		52	34
48	30		48	30
49	31		48	30
50	32		83	53
51	33		80	50
52	34		69	45
53	35		45	2D
54	36		51	33
55	37		32	20
56	38		32	20
57	39		32	20
58	3A	32	20	
59	3B	Part / Model Number Type/Length, 15-byte allocation = CFH	207	CF
60	3C	Part / Model Number "D" = 44H "S" = 53H "2" = 32H "4" = 34H "0" = 30H "O" = 30H "S" = 53H "P" = 50H "E" = 45H "_" = 2DH "3" = 33H	68	44
61	3D		83	53
62	3E		50	32
63	3F		52	34
64	40		48	30
65	41		48	30
66	42		83	53
67	43		80	50
68	44		69	45
69	45		45	2D
70	46		51	33
71	47		32	20
72	48		32	20
73	49		32	20
74	4A		32	20
75	4B	PRODUCT VERSION NUMBER Type/Length 2-byte allocation = C2H (Per unit)	194	C2
76	4C	"0" = 30H	48	30
77	4D	"A" = 41H	65	41
78	4E	PRODUCT SERIAL NUMBER Type/Length, 13-byte allocation = CDH	205	CD

COMMUNICATION BUS DESCRIPTIONS

DS2400SPE series FRU (EEPROM) Data:

OFFSET		DEFINITION (REMARKS)	SPEC VALUE	
(DEC)	(HEX)		(DEC)	(HEX)
79	4F	Model ID	XX	XX
80	50		XX	XX
81	51		XX	XX
82	52		XX	XX
83	53	MANUFACTURING YEAR AND WEEK CODE	XX	XX
84	54		XX	XX
85	55	Unique Serial Number	XX	XX
86	56		XX	XX
87	57		XX	XX
88	58		XX	XX
89	59	MODEL REVISION Should track model revision indicated on model label.	XX	XX
90	5A		XX	XX
91	5B	MANUFACTURING LOCATION "P" In Decimal = 080 In Hex = 50H	80	50
92	5C	Product Serial Number: ASSET TAG (Default = 0)	0	00
93	5D	End Tag In Decimal: 193 In Hex: 0C1H	193	C1
94	5E	Reserved	0	00
95	5F		0	00
96	60		0	00
97	61		0	00
98	62		0	00
99	63		0	00
100	64		0	00
101	65		0	00
102	66		0	00
103	67	ZERO CHECK SUM (Per unit)	XX	XX
MULTI RECORD AREA, 72 BYTES				
104	68	Power Supply Record Header (72 bytes) Record Type ID (0x00 = Power supply information) 3-0: (0010)b, Record Format Version Record length: 24 bytes Record checksum (zero checksum from 109d to 132d) Header checksum (zero checksum from 104d to 107d)	0	00
105	69		2	02
106	6A		24	18
107	6B		196	C4
108	6C		34	22
POWER SUPPLY RECORD				
109	6D	Overall Capacity of The Power Supply , 2 bytes sequence, 1200W = 0960H 15-12: (0000)b, reserved 11-0: 2400W = 0960H	96	60
110	6E		09	09
111	6F	Peak VA , 2 bytes sequence 15-12: (0000)b, reserved 11-0: FFFFH if not specified.	255	FF
112	70		255	FF
113	71	Inrush Current , 45A In Hex = 2DH	45	2D
114	72	Inrush Interval , In Decimal = 200 In Hex = C8H	200	C8
115	73	Low End Input Voltage Range 1 (10mV) , (90V / 10mV) 9000 = 2328H 2 bytes sequence In Decimal = 040, 035 In Hex = 28H, 23H	40	28
116	74		35	23

COMMUNICATION BUS DESCRIPTIONS

DS2400SPE series FRU (EEPROM) Data:

OFFSET		DEFINITION (REMARKS)	SPEC VALUE	
(DEC)	(HEX)		(DEC)	(HEX)
117 118	75 76	High End Input Voltage Range 1 (10mV) , (140V/10mV) 14000 = 36B0H 2 bytes sequence In Decimal = 176, 054 In Hex = B0H, 36H	176 54	B0 36
119 120	77 78	Low End Input Voltage Range 2 (10mV) 180V = 18000 (x10mV) = 4650H In Decimal = 080, 070 In Hex = 50H, 46H	80 70	50 46
121 122	79 7A	High End Input Voltage Range 2 (10mV) 264V = 26400 (x10mV) = 6720H In Decimal = 032, 103 In Hex = 20H, 67H	32 103	20 67
123	7B	Low End Input Frequency Range , 47Hz = 2FH	47	2F
124	7C	High End Input Frequency Range , 63Hz = 3FH	63	3F
125	7D	AC Dropout Tolerance in ms , 10mS = 0AH	10	0A
126	7E	Binary Flags , "1" indicates function supported and a "0" indicates function not supported. Bits 7-5: RESERVED, write as 000B Bit 4: Tachometer pulses per rotation / predictive fail polarity BIT = 0 Bit 3: Hot swap / redundancy support BIT = 1 Bit 2: Auto switch support BIT = 0 Bit 1: Power factor correction support BIT = 1 Bit 0: Predictive fail support BIT = 0	26	1A
127 128	7F 80	Peak Wattage Capacity and Holdup Time , not applicable Bits 15-12: Holdup time in seconds Bits 11-0: Peak capacity in Watts	0 0	00 00
129 130 131	81 82 83	Combined Wattage , not applicable Byte 1: Bits 7-4: Voltage1 Bits 3-0: Voltage2 Byte 2 and Byte 3: Total combined wattage Stored with LSB first then MSB	0 0 0	00 00 00
132	84	Predictive Fail Tachometer Lower Threshold , not applicable. Predictive failure is not supported.	0	00
12VDC OUTPUT RECORD HEADER				
133 134 135 136 137	85 86 87 88 89	Record type = 01 for DC output record End of list /record format version number for 12VDC output record Record length of 12VDC output record: 13 bytes Record CHECKSUM of 12VDC output record (Zero CHECKSUM) (256-(sum of bytes 138 to 150) Header CHECKSUM of 12VDC output record header (Zero CHECKSUM) (256-(sum of bytes 133 to 136)	1 2 13 238 02	01 02 0D EE 02
12V OUTPUT RECORD				
138	8A	Output Information , 001 = 01H	1	01
139 140	8B 8C	Nominal Voltage (10mV) , (12V/10mV) 1200 = 04B0H 2 bytes sequence In Decimal: 176, 004 In Hex: B0H, 04H	176 4	B0 04
141 142	8D 8E	Maximum Negative Voltage Deviation (10mV) , 1160 = 0488H 2 bytes sequence In Decimal: 136, 004 In Hex: 88H, 04H	136 4	88 04

COMMUNICATION BUS DESCRIPTIONS

DS2400SPE series FRU (EEPROM) Data:

OFFSET		DEFINITION (REMARKS)	SPEC VALUE	
(DEC)	(HEX)		(DEC)	(HEX)
143	8F	Maximum Positive Voltage Deviation (10mV) , 1280 = 0500H 2 bytes sequence	00	00
144	90		5	05
145	91	Ripple and Noise pk-pk (mV) , 120 = 78H 2 bytes sequence In Decimal: 120, 000 In Hex: 78H, 00H	120	78
146	92		0	00
147	93	Minimum Current Draw (10mA) , 0050 = 0032H 2 bytes sequence In Decimal: 050, 000 In Hex: 32H, 00H	50	32
148	94		0	00
149	95	Maximum Current Draw (10mA) , 196.7A = 19670 (x10mA) = 4CD6H 2 bytes sequence In Decimal: 214, 076 In Hex: D6H, 4CH	214	D6
150	96		76	4C
12VSB OUTPUT RECORD HEADER				
151	97	Record type = 01 for DC output record	1	01
152	98	End of list / record format version number for 12Vsb output record	130	82
153	99	Record length of 12Vsb output record: 13 bytes	13	0D
154	9A	Record CHECKSUM of 12Vsb output record (zero CHECKSUM) (256-(sum of bytes 156 to 168))	129	81
155	9B	Header CHECKSUM of 12Vsb output record header (zero CHECKSUM) (256-(sum of bytes 151 to 154))	239	EF
12VSB OUTPUT RECORD				
156	9C	Output Information , 002 = 02H Bit 7: Standby information = 1B Bits 6-4: Reserved, write as 000B Bits 3-0: Output number 2 = 010B	130	82
157	9D	Nominal Voltage (10mV) , 12.00V = 1200 (x10mV) = 04B0H 2 bytes sequence	176	B0
158	9E		4	04
159	9F	Maximum Negative Voltage Deviation (10mV) , 11.40V = 1140 (x10mV) = 0474H 2 bytes sequence	116	74
160	A0		04	04
161	A1	Maximum Positive Voltage Deviation (10mV) , 12.6V = 1260 (x10mV) = 04ECH 2 bytes sequence	236	EC
162	A2		4	04
163	A3	Ripple and Noise Pk-Pk (mV) , 120mV = 0078H 2 bytes sequence	120	78
164	A4		0	00
165	A5	Minimum Current Draw (10mA) , 0010 = 000AH 2 bytes sequence	10	0A
166	A6		0	00
167	A7	Maximum Current Draw (10mA) , 0350 = 015EH 2 bytes sequence	94	5E
168	A8		1	01
OEM RECORD HEADER				
161	A1	Record type = C0H for OEM record	192	C0
162	A2	End of list / Record format version number for 3.3Vsb output record	130	82

COMMUNICATION BUS DESCRIPTIONS

DS2400SPE series FRU (EEPROM) Data:

OFFSET		DEFINITION (REMARKS)	SPEC VALUE	
(DEC)	(HEX)		(DEC)	(HEX)
169	A9	RESERVED	0	00
170	AA	RESERVED	0	00
171	AB	RESERVED	0	00
172	AC	RESERVED	0	00
173	AD	RESERVED	0	00
174	AE	RESERVED	0	00
175	AF	RESERVED	0	00
176	B0	PAD (reserved), default value is 0.	1	01
177	B1		0	00
178	B2		0	00
179	B3		0	00
180	B4		0	00
181	B5		0	00
182	B6		0	00
183	B7		0	00
184	B8		0	00
185	B9		0	00
186	BA		0	00
187	BB		0	00
188	BC		0	00
189	BD		0	00
190	BE		0	00
191	BF		0	00
192	C0		0	00
193	C1		0	00
194	C2		0	00
195	C3		0	00
196	C4		0	00
197	C5		0	00
198	C6		0	00
199	C7		0	00
200	C8		0	00
201	C9		0	00
202	CA		0	00
203	CB		0	00
204	CC		0	00
205	CD		0	00
206	CE		0	00
207	CF		0	00
208	D0		0	00
209	D1		0	00
210	D2		0	00
211	D3		0	00
212	D4		0	00
213	D5		0	00
214	D6		0	00
215	D7		0	00
216	D8		0	00
217	D9		0	00
218	DA		0	00
219	DB		0	00
220	DC		0	00
221	DD		0	00
222	DE		0	00
223	DF		0	00
224	E0		0	00
225	E1		0	00

COMMUNICATION BUS DESCRIPTIONS

DS2400SPE series FRU (EEPROM) Data:

OFFSET		DEFINITION (REMARKS)	SPEC VALUE	
(DEC)	(HEX)		(DEC)	(HEX)
226	E2	RESERVED, default value is 0.	0	00
227	E3		0	00
228	E4		0	00
229	E5		0	00
230	E6		0	00
231	E7		0	00
232	E8		0	00
233	E9		0	00
234	EA		0	00
235	EB		0	00
236	EC		0	00
237	ED		0	00
238	EE		0	00
239	EF		0	00
240	F0		0	00
241	F1		0	00
242	F2		0	00
243	F3		0	00
244	F4		0	00
245	F5		0	00
246	F6		0	00
247	F7		0	00
248	F8		0	00
249	F9		0	00
250	FA		0	00
251	FB		0	00
252	FC		0	00
253	FD		0	00
254	FE		0	00
255	FF		0	00

PMBus™ SPECIFICATIONS

The DS2400SPE series is compliant with the industry standard PMBus™ protocol for monitoring and control of the power supply via the I²C interface port.

DS2400SPE Series PMBus™ General Instructions

Equipment Setup

The following is typical I²C communication setup:

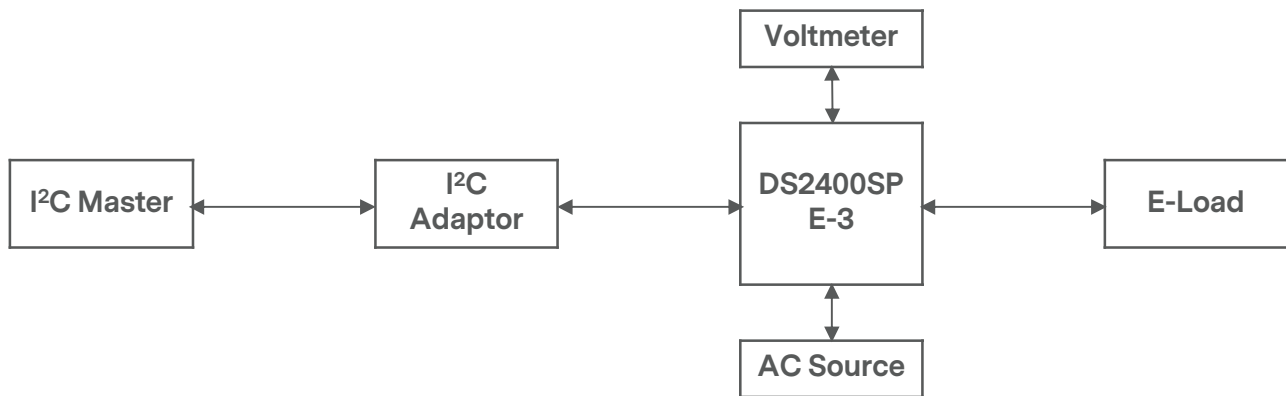

PMBus™ SPECIFICATIONS

The DS2400SPE Series Supported PMBus™ Command List:

Command Code	Command Name	Default Value	Access Type	Data Bytes	Data Format	Description
00h	PAGE	00	R/W	1	Hex	
01h	OPERATION	80	R/W	1	Bitmapped	Used to turn the unit ON/OFF.
	b7:6	10				00 - Immediate turn OFF (No sequencing) 10 - PSU ON Margining not supported.
	b5:0	00000				Reserved
02h	ON_OFF_CONFIG	1D	R	1	Bitmapped	Configures the combination of CONTROL pin and serial communication commands needed to turn the unit ON/OFF.
	b7:5					Reserved
	b4 - Enable CONTROL pin and serial communication control.	1				0 - Unit powers up any time power is present regardless of the state of CONTROL pin. 1 - Unit powers up as dictated by CONTROL pin and OPERATION command (b3:0).
	b3 - Serial communication control	1				0 - Unit ignores ON/OFF portion of the OPERATION command. 1 - Enables serial communication ON/OFF portion of OPERATION command. Requires CONTROL pin to be asserted for the unit to start and energize the output.
	b2 - Sets how the unit responds to CONTROL pin	1				0 - Unit ignores CONTROL pin. (ON/OFF controlled by OPERATION command). 1 - Unit requires CONTROL pin to be asserted to start the unit.
	b1 - CONTROL pin polarity	0				0 - Active low (Pull low to start the unit) 1 - Active high (Pull high to start the unit)
	b0 - CONTROL pin action	0				0 - Use programmed turn ON/OFF delay. 1 - Turn OFF the output and stop transferring energy to the output as fast as possible.
03h	CLEAR_FAULTS		S			
05h	PAGE_PLUS_WRITE	00	BW	Varies		
06h	PAGE_PLUS_READ	00	BR/BW	Varies		
10h	WRITE_PROTECT	80	R/W	1	Bitmapped	

PMBus™ SPECIFICATIONS

The DS2400SPE Series Supported PMBus™ Command List:

Command Code	Command Name	Default Value	Access Type	Data Bytes	Data Format	Description
19h	CAPABILITY	90	R	1	Bitmapped	Provides a way for the hosts system to determine some key capabilities of a PMBus™ device.
	b7 - Packet Error Checking					0 - PEC not supported 1 - PEC supported
	b6 - Maximum Bus Speed					0 - Maximum supported bus speed, 100KHz 1 - Maximum supported bus speed, 400KHz
	b5 - SMBALERT					0 - SMBus Alert Pin not supported. 1 - SMBus Alert Pin supported.
	b4:0					Reserved
1Ah	QUERY	-	BR/BW	2	Hex	Used to determine if the PSU supports a specific command; It should return the proper information about any commands listed.
1Bh	SMBALERT_MASK		BR/BW	2	Direct	Used with STATUS_INPUT, STATUS_TEMPERATURE, STATUS_IOUT.
20h	VOUT_MODE		R	2		Specifies the mode and parameters of output voltage related data formats.
21h	VOUT_COMMAND		R	2	Direct	Sets the output voltage reference. Vout command sends discreet value to change or trim output voltage. The value acts as digital reference of the power supply after additional operations are performed (to make the representation compatible). Affects OVP_WARNING and FAULT LIMIT, as well as POWER_GOOD_ON/OFF level.
30h	COEFFICIENTS		BW/BR	5	Direct	Use to retrieve the m, b and R coefficients, needed for DIRECT data format.
	byte 5	00				R byte
	byte 4:3	0000				b low Byte, b high byte
	byte 2:1	0001				m low Byte, m high byte

PMBus™ SPECIFICATIONS

The DS2400SPE Series Supported PMBus™ Command List:

Command Code	Command Name	Default Value	Access Type	Data Bytes	Data Format	Description
3Ah	FAN_CONFIG_1_2	90	R	1	Bitmapped	
	b7	1				0 - No fan is installed in position 1. 1 - Fan is installed in position 1.
	b6	0				0 - Fan is commanded in RPM. 1 - Fan is commanded is DC.
	b5:4	01				00 - 1 pulse per revolution 01 - 2 pulses per revolution 10 - 3 pulses per revolution 11 - 4 pulses per revolution
	b3	0				1 - Fan is installed in position 2. 0 - No fan is installed in position 2.
	b2	0				1 - Fan is commanded in RPM. 0 - Fan is commanded in DC.
	b1:0	00				00 - 1 pulse per revolution 01 - 2 pulses per revolution 10 - 3 pulses per revolution 11 - 4 pulses per revolution
3Bh	FAN_COMMAND_1	0000	R/W	2	Linear	Adjusts the operation of the fans. The device may override the command, if it requires higher value, to maintain proper device temperature. Duty cycle control - commands speeds from 0 to 100%.
40h	VOUT_OV_FAULT_LIMIT	801C	R/W	2	Linear	Sets output over voltage threshold. (14.25V)
44h	VOUT_UV_FAULT_LIMIT	9812	R/W	2	Linear	Sets under-voltage fault threshold. (9.297V)
46h	IOUT_OC_FAULT_LIMIT	D7F3	R/W	2	Linear	Sets the over current threshold in Amps. (245.75A)
4Ah	IOUT_OC_WARN_LIMIT	13F3	R/W	2	Linear	Sets the output over current warning threshold in Amps. (196.75A)
5Dh	IIN_OC_WARN_LIMIT	HL: 00DA LL: 50DA	R/W	2	Linear	Sets the input over current warning threshold in Amps. (16A for high line and 18.5A for low line)
6Bh	PIN_OP_WARN_LIMIT	HL: A312 LL: 9011	R/W	2	Linear	HL: 2700W LL: 1600W Sets the input over power warning threshold in Watts. (2700W for high line and 1600W for low line)

PMBus™ SPECIFICATIONS

The DS2400SPE Series Supported PMBus™ Command List:

Command Code	Command Name	Default Value	Access Type	Data Bytes	Data Format	Description
78h	STATUS_BYTE		R	1		Returns the summary of critical faults.
	b6 - OFF					Unit is OFF.
	b5 - VOUT_OV					Output over-voltage fault has occurred.
	b4 - IOUT_OC					Output over-current fault has occurred.
	b3 - VIN_UV					An input under-voltage fault has occurred.
	b2 - TEMPERATURE					A temperature fault or warning has occurred.
	b1 - CML					A communication, memory or logic fault has occurred.
79h	STATUS_WORD		R	2	Bitmapped	Summary of units fault and warning status.
	b15 - VOUT					An output voltage fault or warning has occurred.
	b14 - IOUT					An output current or power fault or warning has occurred.
	b13 - INPUT					An input voltage, current or power fault or warning as occurred.
	b11 - POWER_GOOD#					The POWER_GOOD signal is de-asserted.
	b10 - FANS					A fan or airflow fault or warning has occurred.
	b9 - OTHERS					A bit in STATUS_OTHER is set.
	b6 - OFF					Unit is OFF.
	b5 - VOUT_OV					Output over-voltage fault has occurred.
	b4 - IOUT_OC					Output over-current fault has occurred.
	b3 - VIN_UV					An input under-voltage fault has occurred.
	b2 - TEMPERATURE					A temperature fault or warning has occurred.
	b1 - CML					A communication, memory or logic fault has occurred.
	b0 - NONE OF THE ABOVE	-				A fault warning not listed in bits[7:1] has occurred. Not supported
7Ah	STATUS_VOUT		R	1	Bitmapped	
	b7 - VOUT Over-voltage Fault					VOUT Over-voltage fault
	b4 - VOUT Under-voltage Fault					VOUT Under-voltage fault
7Bh	STATUS_IOUT		R	1	Bitmapped	
	b7 - IOUT Overcurrent Fault					IOUT Overcurrent fault
	b5 - IOUT Overcurrent Warning					IOUT Overcurrent warning

PMBus™ SPECIFICATIONS

The DS2400SPE Series Supported PMBus™ Command List:

Command Code	Command Name	Default Value	Access Type	Data Bytes	Data Format	Description
7Ch	STATUS_INPUT		R	1	Bitmapped	Input related faults and warnings
	b7 - VIN_OV_FAULT					VIN Over-voltage fault
	b4 - VIN_UV_FAULT					VIN Under-voltage fault
	b3 - Unit Off for Low Input Voltage					Unit is OFF for insufficient input voltage.
	b1 - IIN_OC_WARNING					IIN Overcurrent warning
7Dh	STATUS_TEMPERATURE		R	1	Bitmapped	Temperature related faults and warnings
	b7 - Over Temperature Fault					Over temperature fault
	b6 - Over Temperature Warning					Over temperature warning
7Eh	STATUS_CML		R	1	Bitmapped	Communications, logic and memory
	b7 - Invalid / Unsupported command					Invalid or unsupported command Received
	b6 - Invalid / Unsupported Data					Invalid data
	b5 - Packet Error Check Failed					Packet error check failed
80h	STATUS_MFR_SPECIFIC		R	1	Bitmapped	
	b7 - Current Share Warning					Current share warning
	b6 - 12Vaux Under-voltage or Over-current Fault					12Vaux under-voltage or overcurrent fault
	b5 - 12V Over-current Fault					12V Over-current Fault
	b4 - 12Vaux Over-voltage Fault					12Vaux Over-voltage Fault
	b3 - 12V Under-voltage Fault					12V Under-voltage Fault
	b2 - 12V Over-voltage Fault					12V Over-voltage Fault
	b1 - Thermal Fault					Thermal Fault
b0 - Fan Fault					Fan Fault	
81h	STATUS_FANS_1_2		R	1	Bitmapped	
	b7 - Fan1 Fault					Fan1 Fault
	b5 - Fan1 Warning					Fan1 Warning
	b3 - Fan 1 Speed Overridden					Fan 1 Speed Overridden
86h	READ_EIN		BR	6	Direct	Returns the accumulated input power over time.
87h	READ_EOUT		BR	6	Direct	Returns the accumulated output power over time.
88h	READ_VIN		R	2	Linear	Returns input voltage in Volts ac.
89h	READ_IIN		R	2	Linear	Returns input current in Amperes
8Bh	READ_VOUT		R	2	Linear	Returns the actual, measured voltage in Volts.
8Ch	READ_IOUT		R	2	Linear	Returns the output current in amperes.
8Dh	READ_TEMPERATURE_1 (Ambient)		R	2	Linear	Returns the ambient temperature in degree Celsius.
8Eh	READ_TEMPERATURE_2 (Hot Spot 1)		R	2	Linear	Returns the hot spot 1 temperature in degree Celsius.

PMBus™ SPECIFICATIONS

The DS2400SPE Series Supported PMBus™ Command List:

Command Code	Command Name	Default Value	Access Type	Data Bytes	Data Format	Description
8Fh	READ_TEMPERATURE_3 (Hot Spot 2)		R	2	Linear	Returns the hot spot 2 temperature in degree Celsius.
90h	READ_FAN_SPEED_1		R	2	Linear	Speed of fan 1
96h	READ_POUT		R	2	Linear	Returns the output power, in Watts.
97h	READ_PIN		R	2	Linear	Returns the input power, in Watts.
98h	PMBUS_REVISION		R	1	Bitmapped	Reads the PMBus revision number.
99h	MFR_ID		BR, ASCII	4		Abbrev or symbol of manufacturers name.
9Ah	MFR_MODEL		BR, ASCII	15		Manufacturers model number, ASCII format
9Bh	MFR_REVISION		BR, ASCII	2		Manufacturers, revision number, ASCII format
9Ch	MFR_LOCATION		BR, ASCII	16		Manufacturers facility, ASCII format
9Dh	MFR_DATA		BR	6		Manufacture date (YYYYMMDD)
9Eh	MFR_SERIAL		BR	13		Unit serial number, ASCII format.
A0h	MFR_VIN_MIN	5A00	R	2	Linear	Minimum input voltage (90Vac)
A1h	MFR_VIN_MAX	0801	R	2	Linear	Maximum input voltage (264Vac)
A2h	MFR_IIN_MAX	00DA	R	2	Linear	Maximum input current (16A)
A3h	MFR_PIN_MAX	HL: A312 LL: 9011	R		Linear	Maximum input power (2700W for high line and 1600W for low line)
A4h	MFR_VOUT_MIN	3317	R	2	Linear	Minimum output voltage. (11.6V)
A5h	MFR_VOUT_MAX	9A19	R	2	Linear	Maximum output voltage. (12.8V)
A6h	MFR_IOUT_MAX	HL: 13F3 LL: 96EB	R	2	Linear	Maximum output current (196.75A for high line and 114.75 for low line)
A7h	MFR_POUT_MAX	HL: 5812 LL: 5E11	R	2	Linear	Maximum output power (2400W for high line and 1400W for low line)
A8h	MFR_TAMBIENT_MAX	3700	R	2	Linear	Maximum operating ambient temperature (secondary ambient) (55degC)
A9h	MFR_TAMBIENT_MIN	0A00	R	2	Linear	Minimum operating ambient temperature (secondary ambient) (10degC)
AAh	MFR_EFFICIENCY_LL		BR	14		Sets or retrieves information about the efficiency of the device while operating at a low line condition. Vin: 115V / P(L): 280W / E(L): 88% / P(M): 700W / E(M): 92% / P(H): 1400W / E(H): 91%
ABh	MFR_EFFICIENCY_HL		BR	14		Sets or retrieves information about the efficiency of the device while operating at a high line condition. Vin: 230V / P(L): 480W / E(L): 93% / P(M): 1200W / E(M): 94% / P(H): 2400W / E(H): 91%

APPLICATION NOTES

Current Sharing

The DS2400SPE series main output V_O is equipped with current sharing capability. When two or more power supplies are connected and operating in parallel, the sharing accuracy between units must be within the limits specified in the table below.

The power supply supports up to 4 units in parallel. Current sharing below 7% load per unit is not required.

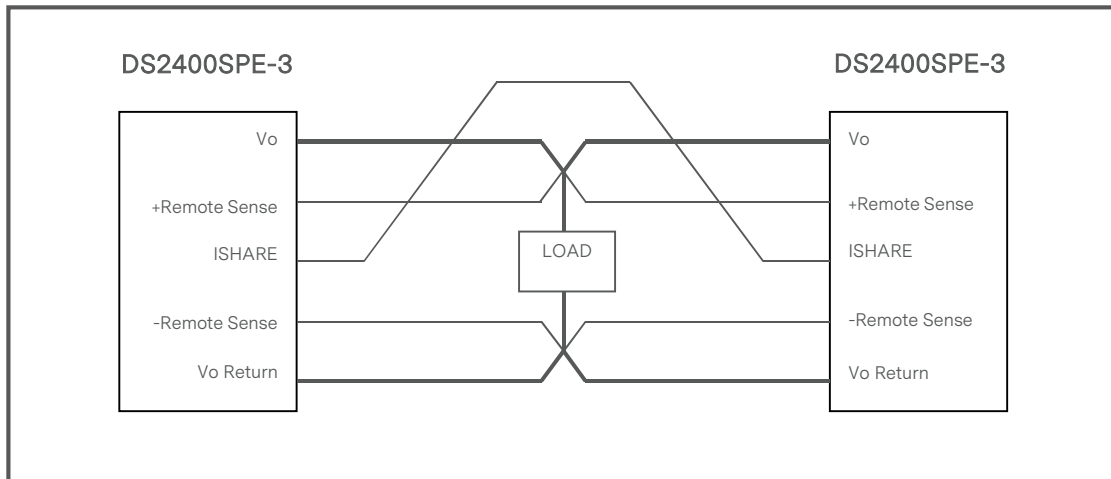

Current Sharing Accuracy:

Load (per power supply unit)	Max Difference between PSUs
10% - 100%	8.0A
<10%	10.0A

APPLICATION NOTES

Output Ripple and Noise Measurement

The setup outlined in the diagram below has been used for output voltage ripple and noise measurements on the DS2400SPE series. When measuring output ripple and noise, a scope jack in parallel with a 0.1 μ F ceramic chip capacitor, and a 10 μ F tantalum capacitor will be used. Oscilloscope can be set to 20MHz bandwidth for this measurement.

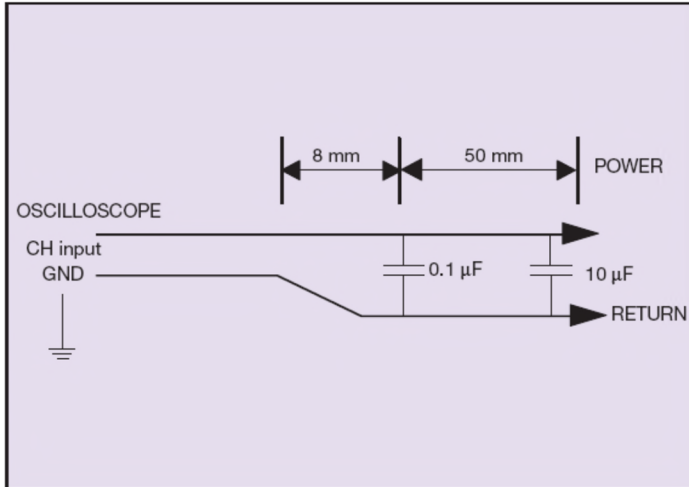

RECORD OF REVISION AND CHANGES

Issue	Date	Description	Originators
1.0	08.13.2019	First Issue	E. Wang
1.1	03.04.2021	Update cover and back cover	C. Liu
1.2	06.01.2022	Update UKCA mark	E. Wang
1.3	03.21.2024	Update max input current to 16.0A max	E. Wang



For international contact information,
visit advancedenergy.com.

powersales@aei.com (Sales Support)
productsupport.ep@aei.com (Technical Support)
+1 888 412 7832

ABOUT ADVANCED ENERGY

Advanced Energy (AE) has devoted more than four decades to perfecting power for its global customers. AE designs and manufactures highly engineered, precision power conversion, measurement and control solutions for mission-critical applications and processes.

Our products enable customer innovation in complex applications for a wide range of industries including semiconductor equipment, industrial, manufacturing, telecommunications, data center computing, and medical. With deep applications know-how and responsive service and support across the globe, we build collaborative partnerships to meet rapid technological developments, propel growth for our customers, and innovate the future of power.

PRECISION | POWER | PERFORMANCE | TRUST

Specifications are subject to change without notice. Not responsible for errors or omissions. ©2020 Advanced Energy Industries, Inc. All rights reserved. Advanced Energy®, and AE® are U.S. trademarks of Advanced Energy Industries, Inc.