

ARTESYN SIL/SMT20C2 SERIES

C-Class Non-Isolated



Advanced Energy's Artesyn SMT20C2 series surface mount 20 amp non-isolated DC-DC converter is designed for cost- and space-sensitive applications. It accepts a wide range 4.5 to 13.8 Vdc input and provides an output that is adjustable from 0.59 to 5.1 Vdc to accommodate a wide variety of silicon power needs. Rated at 100 watts, the converter has a typical efficiency of 93%. Standard features include remote sense, remote On/Off and remote 'power good' indication.

SPECIAL FEATURES

- 20 A current rating
- Input voltage range: 4.5 - 13.8 Vdc
- Output voltage: 0.59 - 5.1 V
- Industry-leading value
- Cost optimized design
- Excellent transient response
- Output enable
- Output voltage adjustability
- Path for future upgrades
- Supports silicon voltage migration
- Reduced design-in and qual time
- Current sink capability
- RoHS compliant
- Two year warranty

SAFETY

- UL, cUL CAN/CSA 22.2 No.
- TÜV Product Service (EN60950)
- CB report and certificate to IEC60950

DATA SHEET

Total Power:

20 Amps

Input Voltage:

4.5 - 13.8 Vdc

of Outputs:

Single



ELECTRICAL SPECIFICATIONS

Input		
Input voltage range		4.5 - 13.8 Vdc
Input current	Minimum load Remote OFF	50 mA 5 mA
Input current (max.)	See Note 3	18 A @ I _o max.
Start-up time	Remote ON/OFF	3 ms
Output		
Output voltage	See Note 5	0.59 - 5.1 V
Output setpoint accuracy	0.1% trim resistors	±1.0%
Line regulation	Low line to high line	±0.2%
Load regulation	Full load to min. load	±0.5%
Min./max. load		0 A/20 A
Overshoot	At turn-on	0.5% max.
Undershoot	At turn-off	100 mV max.
Ripple and noise 5 Hz to 20 MHz	See Note 1	30 mV V _{in} = 5 V, V _{out} = 2.5 V
Transient response	See Note 1, 2	130 mV max. deviation; 50 μs recovery to within regulation band
General		
Efficiency	V _{in} = 5 V, V _o = 2.5 V, I _o = 20 A	90%
Switching frequency	Fixed	750 kHz
Material flammability		UL94V-0
Approvals and standards		EN60950; UL/cUL6950
Weight		8.50 g (0.03 oz.)
MTBF	12 V @ 40 °C, 100% load Bellcore 332	6,721,853 hours
Coplanarity		150 μm

All specifications are typical at nominal input, full load at 25 °C, unless otherwise stated.

ENVIRONMENTAL SPECIFICATIONS

Thermal performance	Operating ambient temperature	-0 °C to +70 °C
See Note 5	Non-operating temperature	-40 °C to +125 °C
Protection		
Short-circuit	Hiccup, non-latching	
Overvoltage protection	Hiccup, non-latching	
Recommended System Capacitance		
Input	See Note 6	0 µF
Output	See Note 7	0 µF

ORDERING INFORMATION

Model Number ⁽⁸⁾	Output Power (Max.)	Input Voltage	Mount	Output Voltage	Output Current (Min.)	Output Current (Max.)	Efficiency (Typical)	Regulation	
								Line	Load
SIL20C2-00SADJ-HJ	100 W	4.5 - 13.8 Vdc	Horizontal	0.59 - 5.1 V	0 A	20 A	93%	±0.2%	±0.5%
SIL20C2-00SADJ-VJ	100 W	4.5 - 13.8 Vdc	Vertical	0.59 - 5.1 V	0 A	20 A	93%	±0.2%	±0.5%
SMT20C2-00SADJJ	100 W	4.5 - 13.8 Vdc	Horizontal Surface Mount	0.59 - 5.1 V	0 A	20 A	93%	±0.2%	±0.5%

PART NUMBER SYSTEM WITH OPTIONS

Product Family	Rated Output Current	Performance	Generation	Input Voltage	Output Voltage	Mounting Option	RoHS Compliance
SXX	20	C	2	00	SADJ	V	J
SIL = Single In Line SMT = Surface Mount	06 = 6 Amp 15 = 15 Amp 20 = 20 Amp 30 = 30 Amp 40 = 40 Amp	C = Cost Optimized	Blank = Standard 2 = Increased current density	00 = 4.5 - 13.8 V	Single Adjustable Output	V = Vertical H = Horizontal Blank = Horizontal Surface Mount	J = Pb free (RoHS 6/6 compliant)

OUTPUT VOLTAGE ADJUSTMENT

The ultra-wide output voltage trim range offers major advantages to users who select the SIL/SMT40C2 series. It is no longer necessary to purchase a variety of modules in order to cover different output voltages. The output voltage can be trimmed in a range of 0.59 - 5.1 V. When the SIL20C2 converter leaves the factory, the output has been adjusted to the default voltage of 0.59 V.

Notes:

1. Measured as per recommended system capacitance.
2. $di/dt = 10 \text{ A}/\mu\text{s}$, $V_{in} = \text{Nom}$, $T_c = 25 \text{ }^\circ\text{C}$, load change = 0.75 I_o to full I_o and full I_o to 0.75.
3. External input fusing is recommended.
4. Additional part numbers may be available with different output voltages.
5. Airflow dependent, 100 LFM minimum required.
6. No capacitors needed for ripple current stability.
7. No capacitors needed for stability.
8. NOTICE: Some models do not support all options. Please contact your local Artesyn Embedded Power representative or use the on-line model number search tool at <http://www.artesyn.com> to find a suitable alternative.

STANDARD APPLICATION DRAWING

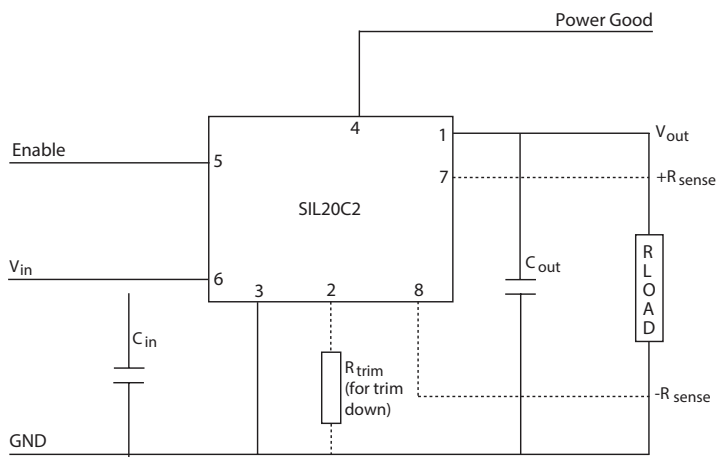

MECHANICAL DRAWINGS

Vertical Mount

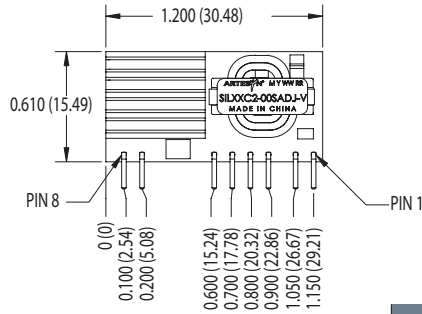
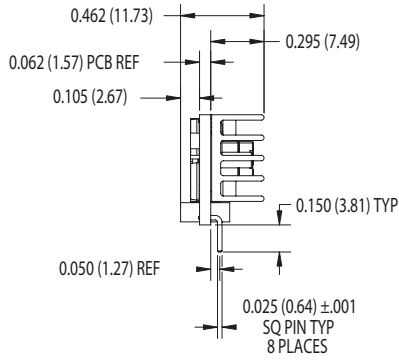

Dimensions in Inches (mm)
Tolerances (unless otherwise specified)
2 Places ±0.030 (±0.76)
3 Places ±0.010 (±0.25)

Pin Assignments	
Pin	Function
1	Vout
2	Trim
3	Ground
4	Power Good
5	Enable
6	Vin
7	Remote Sense (+)
8	Remote Sense (-)

Horizontal Mount

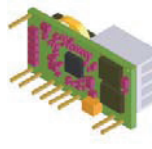
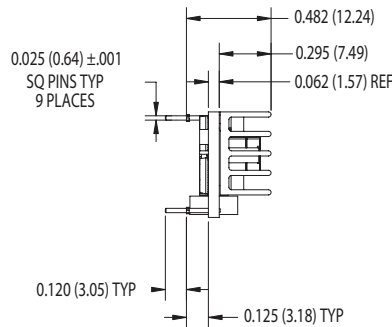
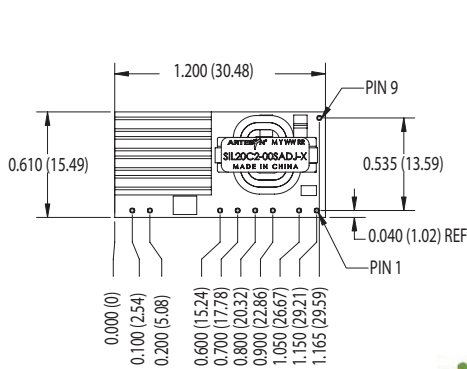

Dimensions in Inches (mm)
Tolerances (unless otherwise specified)
2 Places ±0.030 (±0.76)
3 Places ±0.010 (±0.25)

Pin Assignments	
Pin	Function
1	Vout
2	Trim
3	Ground
4	Power Good
5	Enable
6	Vin
7	Remote Sense (+)
8	Remote Sense (-)
9	Mech Support (Horizontal version only)

MECHANICAL DRAWINGS (CONTINUED)

Surface Mount

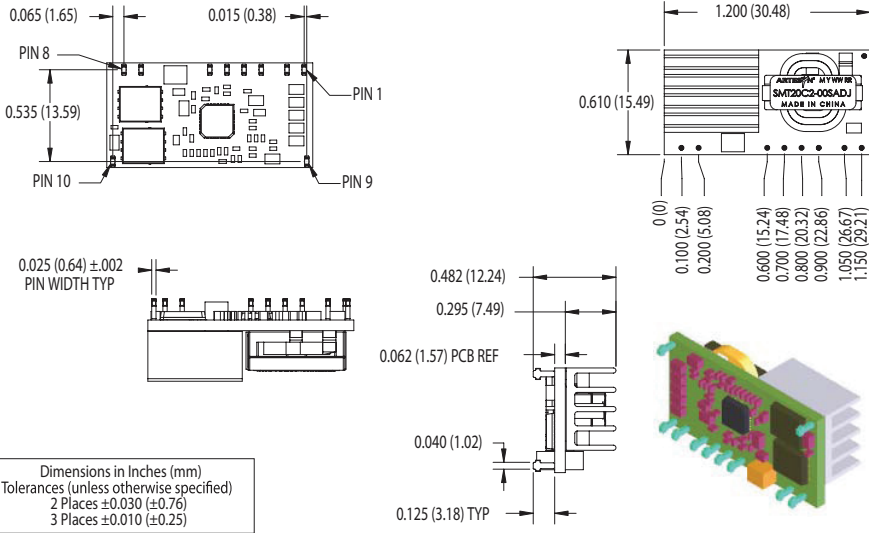

Pin Assignments	
Pin	Function
1	Vout
2	Trim
3	Ground
4	Power Good
5	Enable
6	Vin
7	Remote Sense (+)
8	Remote Sense (-)
9	Mech Support (Horizontal Version only)
10	Mech Support (Horizontal Version only)



For international contact information,
visit advancedenergy.com.

powersales@aei.com (Sales Support)
productsupport.ep@aei.com (Technical Support)
+1 888 412 7832

ABOUT ADVANCED ENERGY

Advanced Energy (AE) has devoted more than three decades to perfecting power for its global customers. AE designs and manufactures highly engineered, precision power conversion, measurement and control solutions for mission-critical applications and processes.

Our products enable customer innovation in complex applications for a wide range of industries including semiconductor equipment, industrial, manufacturing, telecommunications, data center computing, and medical. With deep applications know-how and responsive service and support across the globe, we build collaborative partnerships to meet rapid technological developments, propel growth for our customers, and innovate the future of power.

PRECISION | POWER | PERFORMANCE

Specifications are subject to change without notice. Not responsible for errors or omissions. ©2020 Advanced Energy Industries, Inc. All rights reserved. Advanced Energy®, AE® and Artesyn™ are U.S. trademarks of Advanced Energy Industries, Inc.