

ARTESYN iHP SERIES

Up to 30000 W Configurable Power System



iHP12/15

iHP24/30

PRODUCT DESCRIPTION

Advanced Energy’s Artesyn iHP series power supply is designed for a wide range of medical and industrial applications. The configurable intelligent power system provides accuracy, resolution and stability as either a programmable voltage or current source.

The iHP power system offers developers either an analog or digital interface to their system supporting standard communications protocols. Analog 0 to 5V or 0 to 10V separate for voltage or current, digital Ethernet UDP, RS485, CAN or Ethernet TCP/IP with PowerPro connect Module option. An optional ISOCOMM board provides EtherCAT for use by industrial and semiconductor manufacturing tools.

SPECIAL FEATURES

- Multi output intelligent and modular high power system
- Standard 19” rack
- Outputs parallel up to 1600A
- Outputs series up to 1000V
- 100% digital control
- Outputs program as voltage or current source
- Medical safety approved - no isolation XFMR needed
- Flexible control interfaces
- Air cooled
- Semi F47 compliance
*iHP24L3A & iHP24H3A can support SEMI-F47 compliance for full load without derating
- Field upgradeable firmware
- Programmable slew rate
- Fast current slew rate up to 200 Hz
- Active power factor correction
- User defined command profiles

SAFETY

- UL62368
- UL60950-1 with UL62368-1 (iHP24C3A only)
- CSA C22.2 No.62368-1
- EN62368-1
- EN60601-1; IEC60601-1; IEC60601
- UL60601-1 1st Edition;
- ANSI/AAMI ES60601-1 (2005+C1:09+A2:10) 3rd Edition
- CAN/CSA-C22.2 No. 60601-1(2008)
- CB Certificate and Report
- CE (LVD+RoHS)
- UKCA Mark

AT A GLANCE

Total Power

Up to 30000 W

Input Voltage

180 to 264 Vac

342 to 528 Vac

Single or 3-Phase for iHP12

3-Phase for iHP24

432 to 528 Vac for iHP15,
iHP30/30S

540 to 660Vac 3-Phase for
iHP24C

of Outputs

Up to 8





MODEL NUMBERS

Ordering Information

iHP**XYZA	-	XVZ-XVZ-XVZ-XVZ-	-	XX-**	-	X	-	XXX
①		②		③		④		⑤

①	②	③		④	⑤
Case Type	Module / Voltage	Case Option Codes		CONF Code	MOD Code
**: Case Power 12 = 12 kW 15 = 15 kW 24 = 24 kW 30 = 30 kW 24S ¹ = 24 kW 30S ¹ = 30 kW X: Voltage Range L = Low Range ² 180-264Vac H = High Range 342-528Vac (432-528 for iHP15/30) C = Canadian 540-660Vac Y: Input Phase 1 = Single Phase 3 = 3-Phase Z: Cooling A = Air Cooled A: Accessory options Blank = Standard Configuration C = Factory Configured and Tested 1 = Standard Configuration with ECAT ISOCOMM 2 = Factory Configured and Test with ECAT ISOCOMM 3-9 = Future	X: Output Type S = Single (1-Slot) T = Single (3-Slot) V: Nominal Voltage A = 200V L = 12V Q = 24V T = 32V W = 48V (50 V for 12 kW) 8 = 80V 1 = 125V 2 = 250V 3 = 300V (12 kW) Z: Mode Blank = Standard P = Precision	First Digit 0 = None 1 = Slot 1&2 2 = Slot 2&3 3 = Slot 3&4 4 = Slot 4&5 5 = Slot 5&6 6 = Slot 6&7 7 = Slot 7&8 8 = Slot 1,2&3 9 = Slot 1,2,3&4 A = Slot 1,2,3,4&5 B = Slot 1,2,3,4,5&6 C = Slot 1,2,3,4,5,6&7 D = Slot 1,2,3,4,5,6,7&8 E = Slot 1&2; 3&4 F = Slot 1&2; 3&4; 5&6 G = Slot 1&2; 3&4; 5&6; 7&8 H = Slot 1,2&3; 4&5 J = Slot 1,2&3; 4&5; 6&7 K = Slot 1,2&3; 4,5&6 L = Slot 1,2&3; 4,5&6; 7&8 M = Slot 1,2,3&4; 5&6 N = Slot 1,2,3&4; 5&6; 7&8 P = Slot 1,2,3&4; 5,6&7 R = Slot 1,2,3&4; 5,6,7&8 S = Slot 1,2,3,4&5; 6&7 T = Slot 1,2,3,4&5; 6,7&8 U = Slot 1,2,3,4,5&6; 7&8 Z = Special Defined by MOD Code	Second Digit 0 = None P = Parallel S = Series 1 = Combo 2 P/S 2 = Combo 2 S/P 3 = Combo 3 P/P/S 4 = Combo 3 P/S/P 5 = Combo 3 P/S/S 6 = Combo 3 S/P/P 7 = Combo 3 S/P/S 8 = Combo 3 S/S/P 9 = Combo 4 P/P/P/S A = Combo 4 P/P/S/P B = Combo 4 P/P/S/S C = Combo 4 P/S/P/P D = Combo 4 P/S/P/S E = Combo 4 P/S/S/P F = Combo 4 P/S/S/S G = Combo 4 S/P/P/P H = Combo 4 S/P/P/S J = Combo 4 S/P/S/P K = Combo 4 S/P/S/S L = Combo 4 S/S/P/P M = Combo 4 S/S/P/S N = Combo 4 S/S/S/P	Any alpha characters except "C" = special factory Set-up	
		-** is allowed for secondary series/parallel code 1 = Groups 8 = Groups 1,2&3 9 = Groups 1,2,3&4 E = Gorups 1&2; 3&4 P = Parallel S = Series 1 = Combo 2 P/S 2 = Combo 2 S/P			

Note 1 - Short rack.
 Note 2 - The lowest input voltage for the iHP24L3A is 187.5Vac.

MODEL NUMBERS

Voltage Codes

Output - General Specs										
Module Code	SL	SQ	ST	SW	S8	S1	SA	S2	TW	T3
# Of Outputs	1	1	1	1	1	1	1	1	1	1
Nominal Output (V)	12.0	24.0	32.0	48.0	80.0	125.0	200.0	250.0	50.0	300.0
Max Power (W)	2400	2880	2880	3000	3000	3000	3000	3000	12000	12000
Output Current Range (A)	0-200	0-120	0-90	0-62.5	0-37.5	0-24	0-15	0-12	0-270	0-50
Min Load Capacitor (uF)	0	0	0	0	0	0	0	0	0	0
Max Load Capacitor (uF)	48000	32000	15040	8700	4800	4000	1300	1300	22000	1800
Power Density (W/cu-in)	32.5	39.0	39.0	40.6	40.6	40.6	39.0	40.6	TBA	TBA
Module Input Voltage	400V									
Module Operating Temperature	0 °C to +50 °C at 100% rated load									
Series Operation	250V modules can be connected in series up to 800V for Medical and 1000V for ITE.								No series operation offering	
Parallel Operation	Up to 8 modules can be paralleled in 1 rack.								Up to 2 modules can be paralleled in 1 rack	
	Up to 6 racks connected in parallel. Single wire parallel connection will be provided as part of configuration.									

MODEL NUMBERS

Case Size

Case	Max Output Power	Dimensions	Connections
iHP12/15	12/15kW	502.68 x 482.6 x 132.5mm (19.79" x 19.00" x 5.22")	Terminal-Block
iHP24/30	24/30kW	752.28 x 482.6 x 132.5mm (29.62" x 19.00" x 5.22")	Terminal-Block
iHP24S/30S	24/30kW	645.48 x 482.6 x 132.5mm (25.43" x 19.00" x 5.22")	Terminal-Block
iHP24C	24kW	738.2 x 482.6 x 132.5 mm (29.09" x 19.00" x 5.22")	Terminal-Block

Case Input Type

Terminal Block

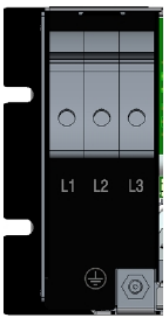

iHP24C3A

For iHP12 and iHP24 L/H/S

For iHP24C case

Note: AC power must be wired to L1, L2, and L3 for 3 phases input and L1&L2 for single phase input.

ELECTRICAL SPECIFICATIONS

Absolute Maximum Ratings

Stress in excess of those listed in the “Absolute Maximum Ratings” may cause permanent damage to the power supply. These are stress ratings only and functional operation of the unit is not implied at these or any other conditions above those given in the operational sections of this TRN. Exposure to any absolute maximum rated condition for extended periods may adversely affect the power supply’s reliability.

Table 1. Absolute Maximum Ratings						
Parameter	Models	Symbol	Min	Typ	Max	Unit
Input Voltage	iHP12L1A	$V_{IN,AC}$	180	-	264	Vac
	iHP12L3A		180	-	264	Vac
	iHP12H3A		342	-	528	Vac
	iHP24H/SH3A		342	-	528	Vac
	iHP24L/SH3A		187.5	-	264	Vac
	iHP24C3A		540	-	660	Vac
Maximum Output Power ¹	iHP12	$P_{O,max}$	-	-	12000	W
	iHP24	$P_{O,max}$	-	-	24000	W
Isolation Voltage ²	Primary to Safety Ground Primary to Secondary Secondary to Safety Ground	12V,15V,24V,48V	-	-	2034	Vac
			-	-	5000	Vac
			-	-	1570	Vac
Isolation Voltage ²	Primary to Safety Ground Primary to Secondary Secondary to Safety Ground	80V,125V,250V	-	-	2034	Vac
			-	-	5000	Vac
			-	-	2400	Vac
Isolation Voltage ²	Primary to Safety Ground Primary to Secondary Secondary to Safety Ground	50V, 200V, 300V	-	-	3470	Vac
			-	-	6107	Vac
			-	-	2636	Vac
Ambient Operating Temperature	All models	T_A	0	-	50 ³	°C
Storage Temperature	All models	T_{STG}	-40	-	85	°C
Humidity (non-condensing)	Operating	All models	20	-	90	%
	Non-operating	All models	10	-	95	%
Altitude ⁴	Operating	All models	-	-	9842	Feet
	Non-operating	All models	-	-	30000	Feet

Note 1 - When operating at 480Vac 3-phase nominal (432 to 528Vac), and using the 12 kW modules, extra slots left available can be populated with the 3 kW single slot modules to provide up to 30 kW (iHP30) in the 8-slot racks and 15 kW (iHP15) in the 4-slot racks for up to 4 outputs.

Note 2 - The duration for the hi-pot voltage is 2sec.

Note 3 - At 100% rated load.

Note 4 - 3000 meters at operating, 9144 meters at non-operating.

ELECTRICAL SPECIFICATIONS

Input Specifications

Table 2. Input Specifications							
Parameter		Condition	Symbol	Min	Typ	Max	Unit
Operating Input Voltage, AC ¹	iHP12L1A	All	$V_{IN,AC}$	180	200/240	264	Vac
	iHP12L3A			180	200/240	264	Vac
	iHP12H3A			342	380/480	528	Vac
	iHP24H/SH3A			342	380/480	528	Vac
	iHP24L/SH3A			187.5	208/240	264	Vac
	iHP24C3A ²			540	600	660	Vac
Input AC Frequency		All	$f_{IN,AC}$	47	50/60	63	Hz
Maximum Input Current/phase	iHP12L1A	$I_O = I_{O,max}$ $I_{SB} = I_{SB,max}$	$I_{IN,max}$	-	-	75	A_{RMS}
	iHP12L3A			-	-	44	A_{RMS}
	iHP12H3A			-	-	23	A_{RMS}
	iHP24H/SH3A			-	-	51	A_{RMS}
	iHP24L/SH3A			-	-	84	A_{RMS}
	iHP24C3A			-	-	29 ³	A_{RMS}
Standby Input Current ($V_O = \text{Off}$, $I_{SB} = 0A$)		All	$I_{IN,standby}$	-	-	1.5	A_{RMS}
Standby Input Power ($V_O = \text{Off}$, $I_{SB} = 0A$)		All	$P_{IN,standby}$	-	-	100	W
No Load Input Current ($V_O = \text{On}$, $I_O = 0A$, $I_{SB} = 0A$)		All	I_{IN,no_load}	-	-	1.5	A_{RMS}
No Load Input Power ($V_O = \text{On}$, $I_O = 0A$, $I_{SB} = 0A$)		All	P_{IN,no_load}	-	-	125	W
Line Interruption		All	Designed to meet SEMI F47-0706, 53, 58, S14 at nominal input voltages.				
Harmonic Line Currents	iHP12L1A iHP12L3A iHP12H3A iHP24H/SH3A iHP24L/SH3A iHP24C3A	$I_O = I_{O,max}$	THD	THD < 13%, PWHD < 22%			

Note 1 - For iHP12L1A, normal rating is 200/220/230/240Vac; For iHP12L3A, normal rating is 200/208/240Vac.

Note 2 - 540Vac to 660Vac L-L (600Vac normal); 312Vac to 382Vac L-N (347Vac normal).

Note 3 - 29A@312Vac, L-N voltage.

ELECTRICAL SPECIFICATIONS

Input Specifications

Table 2. Input Specifications Con't							
Parameter		Condition	Symbol	Min	Typ	Max	Unit
Power Factor	iHP12L1A	$I_O = I_{O,max}$		0.99	-	-	Vac
	iHP12L3A			0.98	-	-	Vac
	iHP12H3A			0.98	-	-	Vac
	iHP24H/SH3A			0.98	-	-	Vac
	iHP24L/SH3A			0.98	-	-	Vac
	iHP24C3A			0.98	-	-	Vac
Inrush Current		$V_{IN,AC} = 264Vac$		2.5*max input current			A_{PK}
Input Fuse ¹		Internal, 10x38mm, Fast Acting 600V		-	-	25	A
Input Leakage Current ²	iHP12L1A	All		-	-	1.25	mA
	iHP12L3A			-	-	1.25	mA
	iHP12H3A			-	-	2.5	mA
	iHP24H/SH3A			-	-	2.5	mA
	iHP24L/SH3A			-	-	2.5	mA
	iHP24C3A			-	-	2.5	mA
PFC Switching Frequency		All	$f_{SW,PFC}$	-	225	-	KHz
Phase Imbalance	iHP12L1A	All		-	-	-	%
	iHP12L3A			-	-	5	%
	iHP12H3A			-	-	5	%
	iHP24H/SH3A			-	-	5	%
	iHP24L/SH3A			-	-	5	%
	iHP24C3A			-	-	5	%
Operating Efficiency ^{3,4} @ 25°C	iHP12L1A	$I_O = I_{O,max}$	η	91/90	-	-	%
	iHP12L3A			91/90	-	-	%
	iHP12H3A			91/90	-	-	%
	iHP24H/SH3A			91/90	-	-	%
	iHP24L/SH3A			91/90	-	-	%
	iHP24C3A			90	-	-	%
Number of Unit in Parallel	Up to 6 racks						
Power Switch	Front panel ON/OFF switch						
Phase Detection	Loss of phase can inhibit unit off. Housekeeping/comms must continue with phase loss.						
Under Voltage Detection	All	Nominal input locked on at turn-on. Under voltage shutdown at 15% below nominal. Turn-on at 12% below nominal. Not to interfere with SEMI F47 specs.					

Note 1 - Input Fuse is distributed to each PFC. Each PFC has 2 input AC Fuse with 25A rating. Not user serviceable.

Note 2 - For fixed EN60601 3rd edition leakage = 5 mA.

Note 3 - Except iHP24C3A, the efficiency >90% at low normal input voltage; >91% at high normal input voltage. For iHP24C3A, the efficiency >90% at 600Vac.

Note 4 - See page 79 for DLC specific efficiency and life calculations.

ELECTRICAL SPECIFICATIONS

12.0V Module Output Specifications (SL)

Table 3. 12.0V Module Output General Specifications:						
Parameter	Condition	Symbol	Min	Typ	Max	Unit
Nominal Output Voltage	All	V_o	-	12.0	-	Vdc
Maximum Power	All	P_o	-	-	2400	W
Output Current	All	I_o	0	-	200	A
Load Capacitor	All	C_o	0	-	48000	uF
Power Density	All		-	32.5	-	W/cu-in
Module Input Voltage	All		-	400	-	Vdc
Module Operating Temperature	All		0	-	65	°C
V_o Current Share Accuracy	All	$\pm\%I_{o,max}$	-	-	10	%
Series Operation	12V, 24V, 32V and 48V modules can be connected in series up to 300V for Medical 2MOPP; up to 400V for Medical 2MOOP & ITE.					
Parallel Operation	Up to 8 modules can be paralleled in 1 rack, with up to 6 racks connected in parallel. Single Wire Parallel connection will be provided as part of configuration.					

ELECTRICAL SPECIFICATIONS

12.0V Module Output Specifications (SL)

Table 4. 12.0V Module in Voltage Source Mode:						
Parameter	Condition	Symbol	Min	Typ	Max	Unit
Nominal Output Voltage	All	V_O	-	12.0	-	Vdc
Output Voltage Adjust Range	All	V_O	0.6	-	14.4	Vdc
Output Line Regulation	All	$\pm V_O$	-	-	12	mV
Output Load Regulation	All	$\pm V_O$	-	-	24	mV
Output Ripple and Noise		V_O	-	-	60	mV _{PK}
Low Frequency Ripple		V_O	-	-	24	mV _{RMS}
Programming Accuracy	Digital Analog	$\pm \%V_O$	- -	- -	0.1 1.0	%
Programming Resolution			-	TBD	-	mV
Measurement Accuracy		$\pm \%V_O$	-	0.2 ²	-	%
Measurement Resolution			-	TBD	-	
V_O Dynamic Response ¹	Peak Deviation Setting Time	50% load change	$\pm \%V_O$ T_s	- -	- -	5 1 % mS
Minimum Dynamic Load	All	I_o	40	-	-	A
V_O Long Term Stability Max change over 8 hours	After thermal equilibrium (30 mins)	$\pm \%V_O$	-	-	0.05	%
Temp Coefficient			-	200	-	PPM/°C
Current Sense Method	Internal Shunt					

Note 1 - Test with 4700uF capacitor.

Note 2 - 0.2% of set output + 0.2% of nominal output voltage.

ELECTRICAL SPECIFICATIONS

12.0V Module Output Specifications (SL)

Table 5. 12.0V Module in Current Source Mode:						
Parameter	Condition	Symbol	Min	Typ	Max	Unit
Nominal Output Voltage	All	V_o	-	12.0	-	Vdc
Output Current Adjust Range	All	I_o	0	-	200	A
Output Current Ripple		I_o	-	-	200	mA_{RMS}
Output Current Line Regulation	All	$\pm I_o$	-	-	200	mA
Output Current Load Regulation	All	$\pm I_o$	-	-	800	mA
Programming Accuracy	Digital Analog	$\pm \%I_{o,\text{max}}$	- -	- -	0.7 1.3	%
Programming Resolution			-	-	79.2	mA
Measurement Accuracy		$\pm \%I_{o,\text{max}}$	-	0.7 ¹	-	%
Measurement Resolution		I_o	-	-	79.2	mA
I_o Dynamic Response	Load#1 (Ohm) – Resistive: Equivalent to 110% of Max Power (@ Vnom) Load#2 (Ohm) – Resistive: Equivalent to 200% of Max Power (@ Vnom)	$\pm \%I_o$ T_s	- -	- -	5 20	% mS
I_o Long Term Stability Max change over 8 hours	After thermal equilibrium (30 mins)	$\pm \%I_o$	-	-	0.05	%
Temp Coefficient			-	300	-	PPM/°C
Current Sense Method	Internal Shunt					

Note 1 - 0.7% + 0.7% of rated output maximum.

ELECTRICAL SPECIFICATIONS

24.0V Module Output Specifications (SQ)

Table 6. 24.0V Module Output General Specifications:						
Parameter	Condition	Symbol	Min	Typ	Max	Unit
Nominal Output Voltage	All	V_o	-	24.0	-	Vdc
Maximum Power	All	P_o	-	-	2880	W
Output Current	All	I_o	0	-	120	A
Load Capacitor	All	C_o	0	-	32000	uF
Power Density	All		-	39.0	-	W/cu-in
Module Input Voltage	All		-	400	-	Vdc
Module Operating Temperature	All		0	-	65	°C
V_o Current Share Accuracy	All	$\pm\%I_{o,max}$	-	-	10	%
Series Operation	12V, 24V, 32V and 48V modules can be connected in series up to 300V for Medical 2MOPP; up to 400V for Medical 2MOOP & ITE.					
Parallel Operation	Up to 8 modules can be paralleled in 1 rack, with up to 6 racks connected in parallel. Single Wire Parallel connection will be provided as part of configuration.					

ELECTRICAL SPECIFICATIONS

24.0V Module Output Specifications (SQ)

Table 7. 24.0V Module in Voltage Source Mode:						
Parameter	Condition	Symbol	Min	Typ	Max	Unit
Nominal Output Voltage	All	V_O	-	24.0	-	Vdc
Output Voltage Adjust Range	All	V_O	1.2	-	28.8	Vdc
Output Line Regulation	All	$\pm V_O$	-	-	24	mV
Output Load Regulation	All	$\pm V_O$	-	-	48	mV
Output Ripple and Noise		V_O	-	-	120	mV _{PK}
Low Frequency RMS Ripple		V_O	-	-	48	mV _{RMS}
Program Accuracy	Digital Analog	$\pm\%V_O$	- -	- -	0.1 1.0	%
Program Resolution			-	1	-	mV
Measure Accuracy		$\pm\%V_O$	-	0.2 ²	-	%
Measure Resolution		$\pm V_O$	-	1	-	mV
V_O Dynamic Response ¹	Peak Deviation Setting Time	50% load change	$\pm\%V_O$ T_s	- -	- -	5 1 % mS
Minimum Dynamic Load	All	I_O	24	-	-	A
V_O Long Term Stability Max change over 8 hours	After thermal equilibrium (30 mins)	$\pm\%V_O$	-	-	0.05	%
Temp Coefficient			-	200	-	PPM/°C
Current Sense Method	Internal Shunt					

Note 1 - Test with 2700uF capacitor.

Note 2 - 0.2% of set output + 0.2% of nominal output voltage.

ELECTRICAL SPECIFICATIONS

24.0V Module Output Specifications (SQ)

Table 8. 24.0V Module in Current Source Mode:							
Parameter	Condition	Symbol	Min	Typ	Max	Unit	
Nominal Output Voltage	All	V_o	-	24.0	-	Vdc	
Output Current Adjust Range	All	I_o	0	-	120	A	
Output Current Ripple		I_o	-	-	120	mA_{RMS}	
Output Line Regulation	All	$\pm I_o$	-	-	200	mA	
Output Load Regulation	All	$\pm I_o$	-	-	800	mA	
Program Accuracy	Digital Analog	$\pm \%I_{o,max}$	- -	- -	0.7 1.3	%	
Program Resolution			-	-	26.4	mA	
Measure Accuracy		$\pm \%I_{o,max}$	-	0.7 ¹	-	%	
Measure Resolution		I_o	-	-	26.4	mA	
I_o Dynamic Response	Peak Deviation Setting time	Load#1 (Ohm) – Resistive: Equivalent to 110% of Max Power (@ Vnom)	$\pm \%I_o$	-	-	5	%
		Load#2 (Ohm) – Resistive: Equivalent to 200% of Max Power (@ Vnom)	T_s	-	-	20	mS
I_o Long Term Stability Max change over 8 hours	After thermal equilibrium (30 mins)	$\pm \%I_o$	-	-	0.05	%	
Temp Coefficient			-	300	-	PPM/°C	
Current Sense Method	Internal Shunt						

Note 1 - 0.7% + 0.7% of rated output maximum.

ELECTRICAL SPECIFICATIONS

32.0V Module Output Specifications (ST)

Table 9. 32.0V Module Output General Specifications:						
Parameter	Condition	Symbol	Min	Typ	Max	Unit
Nominal Output Voltage	All	V_o	-	32.0	-	Vdc
Maximum Power	All	P_o	-	-	2880	W
Output Current	All	I_o	0	-	90	A
Load Capacitor	All	C_o	0	-	15040	uF
Power Density	All		-	39.0	-	W/cu-in
Module Input Voltage	All		-	400	-	Vdc
Module Operating Temperature	All		0	-	65	°C
V_o Current Share Accuracy	All	$\pm\%I_{o,max}$	-	-	10	%
Series Operation	12V, 24V, 32V and 48V modules can be connected in series up to 300V for Medical 2MOPP; up to 400V for Medical 2MOOP & ITE.					
Parallel Operation	Up to 8 modules can be paralleled in 1 rack, with up to 6 racks connected in parallel. Single Wire Parallel connection will be provided as part of configuration.					

ELECTRICAL SPECIFICATIONS

32.0V Module Output Specifications (ST)

Table 10. 32.0V Module in Voltage Source Mode:						
Parameter	Condition	Symbol	Min	Typ	Max	Unit
Nominal Output Voltage	All	V_O	-	32.0	-	Vdc
Output Voltage Adjust Range	All	V_O	1.6	-	38.4	Vdc
Output Line Regulation	All	$\pm V_O$	-	-	32	mV
Output Load Regulation	All	$\pm V_O$	-	-	64	mV
Output Ripple and Noise		V_O	-	-	160	mV _{PK}
Low Frequency RMS Ripple		V_O	-	-	54	mV _{RMS}
Program Accuracy	Digital Analog	$\pm\%V_O$	- -	- -	0.1 1.0	%
Program Resolution			-	TBD	-	mV
Measure Accuracy		$\pm\%V_O$	-	0.2 ²	-	%
Measure Resolution		$\pm V_O$	-	TBD	-	mV
V_O Dynamic Response ¹	Peak Deviation Setting Time	50% load change	$\pm\%V_O$ T_s	- -	- -	5 1 % mS
Minimum Dynamic Load	All	I_O	18	-	-	A
V_O Long Term Stability Max change over 8 hours	After thermal equilibrium (30 mins)	$\pm\%V_O$	-	-	0.05	%
Temp Coefficient			-	200	-	PPM/°C
Current Sense Method	Internal Shunt					

Note 1 - Test with 2200uF capacitor.

Note 2 - 0.2% of set output + 0.2% of nominal output voltage.

ELECTRICAL SPECIFICATIONS

32.0V Module Output Specifications (ST)

Table 11. 32.0V Module in Current Source Mode:						
Parameter	Condition	Symbol	Min	Typ	Max	Unit
Nominal Output Voltage	All	V_o	-	32.0	-	Vdc
Output Current Adjust Range	All	I_o	0	-	90	A
Output Current Ripple		I_o	-	-	120	mA_{RMS}
Output Line Regulation	All	$\pm I_o$	-	-	90	mA
Output Load Regulation	All	$\pm I_o$	-	-	375	mA
Program Accuracy	Digital Analog	$\pm \%I_{o,max}$	- -	- -	0.7 1.3	%
Program Resolution			-	-	7.2	mA
Measure Accuracy		$\pm \%I_{o,max}$	-	0.7 ¹	-	%
Measure Resolution		I_o	-	-	7.2	mA
I_o Dynamic Response	Load#1 (Ohm) – Resistive: Equivalent to 110% of Max Power (@ Vnom) Load#2 (Ohm) – Resistive: Equivalent to 200% of Max Power (@ Vnom)	$\pm \%I_o$ T_s	- -	- -	5 20	% mS
I_o Long Term Stability Max change over 8 hours	After thermal equilibrium (30 mins)	$\pm \%I_o$	-	-	0.05	%
Temp Coefficient			-	300	-	PPM/°C
Current Sense Method	Internal Shunt					

Note 1 - 0.7% + 0.7% of rated output maximum.

ELECTRICAL SPECIFICATIONS

48.0V Module Output Specifications (SW)

Table 12. 48.0V Module Output General Specifications:						
Parameter	Condition	Symbol	Min	Typ	Max	Unit
Nominal Output Voltage	All	V_o	-	48.0	-	Vdc
Maximum Power	All	P_o	-	-	3000	W
Output Current	All	I_o	0	-	62.5	A
Load Capacitor	All	C_o	0	-	8700	uF
Power Density	All		-	40.6	-	W/cu-in
Module Input Voltage	All		-	400	-	Vdc
Module Operating Temperature	All		0	-	65	°C
V_o Current Share Accuracy	All	$\pm\%I_{o,max}$	-	-	10	%
Series Operation	12V, 24V, 32V and 48V modules can be connected in series up to 300V for Medical 2MOPP; up to 400V for Medical 2MOOP & ITE.					
Parallel Operation	Up to 8 modules can be paralleled in 1 rack, with up to 6 racks connected in parallel. Single Wire Parallel connection will be provided as part of configuration.					

ELECTRICAL SPECIFICATIONS

48.0V Module Output Specifications (SW)

Table 13. 48.0V Module in Voltage Source Mode:						
Parameter	Condition	Symbol	Min	Typ	Max	Unit
Nominal Output Voltage	All	V_O	-	48.0	-	Vdc
Output Voltage Adjust Range	All	V_O	2.4	-	57.6	Vdc
Output Line Regulation	All	$\pm V_O$	-	-	48	mV
Output Load Regulation	All	$\pm V_O$	-	-	96	mV
Output Ripple and Noise		V_O	-	-	240	mV _{PK}
Low Frequency RMS Ripple		V_O	-	-	96	mV _{RMS}
Program Accuracy	Digital Analog	$\pm\%V_O$	- -	- -	0.1 1.0	%
Program Resolution			-	2	-	mV
Measure Accuracy		$\pm\%V_O$	-	0.2 ²	-	%
Measure Resolution		$\pm V_O$	-	2	-	mV
V_O Dynamic Response ¹	Peak Deviation Setting Time	50% load change	$\pm\%V_O$ T_s	- -	- -	5 1 % mS
Minimum Dynamic Load	All	I_O	12.5	-	-	A
V_O Long Term Stability Max change over 8 hours	After thermal equilibrium (30 mins)	$\pm\%V_O$	-	-	0.05	%
Temp Coefficient			-	200	-	PPM/°C
Current Sense Method	Internal Shunt; External Shunt can be used for better temperature stability.					

Note 1 - Test with 1000uF capacitor.

Note 2 - 0.2% of set output + 0.2% of nominal output voltage.

ELECTRICAL SPECIFICATIONS

48.0V Module Output Specifications (SW)

Table 14. 48.0V Module in Current Source Mode:						
Parameter	Condition	Symbol	Min	Typ	Max	Unit
Nominal Output Voltage	All	V_o	-	48.0	-	Vdc
Output Current Adjust Range	All	I_o	0	-	62.5	A
Output Current Ripple		I_o	-	-	62.5	mA_{RMS}
Output Line Regulation	All	$\pm I_o$	-	-	125	mA
Output Load Regulation	All	$\pm I_o$	-	-	250	mA
Program Accuracy	Digital Analog	$\pm \%I_{o,max}$	- -	- -	0.7 1.3	%
Program Resolution			-	-	13.2	mA
Measure Accuracy		$\pm \%I_{o,max}$	-	0.7 ¹	-	%
Measure Resolution		I_o	-	-	13.2	mA
I_o Dynamic Response	Load#1 (Ohm) – Resistive: Equivalent to 110% of Max Power (@ Vnom) Load#2 (Ohm) – Resistive: Equivalent to 200% of Max Power (@ Vnom)	$\pm \%I_o$ T_s	- -	- -	5 20	% mS
I_o Long Term Stability Max change over 8 hours	After thermal equilibrium (30 mins)	$\pm \%I_o$	-	-	0.05	%
Temp Coefficient			-	200	-	PPM/°C
Current Sense Method	Internal Shunt					

Note 1 - 0.7% + 0.7% of rated output maximum.

ELECTRICAL SPECIFICATIONS

80.0V Module Output Specifications (S8)

Table 15. 80.0V Module Output General Specifications:						
Parameter	Condition ¹	Symbol	Min	Typ	Max	Unit
Nominal Output Voltage	All	V_o	-	80.0	-	Vdc
Maximum Power	All	P_o	-	-	3000	W
Output Current	All	I_o	0	-	37.5	A
Load Capacitor	All	C_o	0	-	4800	uF
Power Density	All		-	40.6	-	W/cu-in
Module Input Voltage	All		-	400	-	Vdc
Module Operating Temperature	All		0	-	65	°C
V_o Current Share Accuracy	All	$\pm\%I_{o,max}$	-	-	10	%
Series Operation	80V, 125V, 200V and 250V modules can be connected in series up to 600V for Medical 2MOPP; up to 800V for Medical 2MOOP; up to 1000V for ITE.					
Parallel Operation	Up to 8 modules can be paralleled in 1 rack, with up to 6 racks connected in parallel. Single Wire Parallel connection will be provided as part of configuration.					

Note 1 - $V_{out} = V_{nominal}$. $V_{in} = 395V_{dc}$. $P_{out} = \text{Max Power}$. $T_{amb} = 23\text{degC} \pm 5\text{degC}$ (with 30-minute warm-up period).

ELECTRICAL SPECIFICATIONS

80.0V Module Output Specifications (S8)

Table 16. 80.0V Module in Voltage Source Mode:						
Parameter	Condition	Symbol	Min	Typ	Max	Unit
Nominal Output Voltage	All	V_O	-	80.0	-	Vdc
Output Voltage Adjust Range	All	V_O	4.0	-	96.0	Vdc
Output Line Regulation	All	$\pm V_O$	-	-	80	mV
Output Load Regulation	All	$\pm V_O$	-	-	160	mV
Output Ripple and Noise		V_O	-	-	400	mV _{PK}
Low Frequency RMS Ripple		V_O	-	-	160	mV _{RMS}
Program Accuracy	Digital Analog	$\pm\%V_O$	- -	- -	0.1 1.0	%
Program Resolution		$\pm V_O$	-	8	-	mV
Measure Accuracy		$\pm\%V_O$	-	0.2 ²	-	%
Measure Resolution		$\pm V_O$	-	8	-	mV
V_O Dynamic Response ¹	Peak Deviation Setting Time	50% load change	$\pm\%V_O$ T_s	- -	- -	5 1 % mS
Minimum Dynamic Load	All	I_O	7.5	-	-	A
V_O Long Term Stability Max change over 8 hours	After thermal equilibrium (30 mins)	$\pm\%V_O$	-	-	0.05	%
Temp Coefficient			-	200	-	PPM/°C
Current Sense Method	Internal Shunt					

Note 1 - Test with 820uF capacitor.

Note 2 - 0.2% of set output + 0.2% of nominal output voltage.

ELECTRICAL SPECIFICATIONS

80.0V Module Output Specifications (S8)

Table 17. 80.0V Module in Current Source Mode:						
Parameter	Condition	Symbol	Min	Typ	Max	Unit
Nominal Output Voltage	All	V_o	-	80.0	-	Vdc
Output Current Adjust Range	All	I_o	0	-	37.5	A
Output Current Ripple		I_o	-	-	37.5	mA_{RMS}
Output Line Regulation	All	$\pm I_o$	-	-	93.75	mA
Output Load Regulation	All	$\pm I_o$	-	-	150	mA
Program Accuracy	Digital Analog	$\pm \%I_{o,max}$	- -	- -	0.7 1.3	%
Program Resolution			-	-	10	mA
Measure Accuracy		$\pm \%I_{o,max}$	-	0.7 ¹	-	%
Measure Resolution		I_o	-	-	10	mA
I_o Dynamic Response	Load#1 (Ohm) – Resistive: Equivalent to 110% of Max Power (@ Vnom) Load#2 (Ohm) – Resistive: Equivalent to 200% of Max Power (@ Vnom)	$\pm \%I_o$ T_s	- -	- -	5 20	% mS
I_o Long Term Stability Max change over 8 hours	After thermal equilibrium (30 mins)	$\pm \%I_o$	-	-	0.05	%
Temp Coefficient			-	200	-	PPM/°C
Current Sense Method	Internal Shunt					

Note 1 - 0.7% + 0.7% of rated output maximum.

ELECTRICAL SPECIFICATIONS

125.0V Module Output Specifications (S1)

Table 18. 125.0V Module Output General Specifications:						
Parameter	Condition ¹	Symbol	Min	Typ	Max	Unit
Nominal Output Voltage	All	V_o	-	125.0	-	Vdc
Maximum Power	All	P_o	-	-	3000	W
Output Current	All	I_o	0	-	24	A
Load Capacitor	All	C_o	0	-	4000	uF
Power Density	All		-	40.6	-	W/cu-in
Module Input Voltage	All		-	400	-	Vdc
Module Operating Temperature	All		0	-	65	°C
V_o Current Share Accuracy	All	$\pm\%I_{o,max}$	-	-	10	%
Series Operation	80V, 125V, 200V and 250V modules can be connected in series up to 600V for Medical 2MOPP; up to 800V for Medical 2MOOP; up to 1000V for ITE.					
Parallel Operation	Up to 8 modules can be paralleled in 1 rack, with up to 6 racks connected in parallel. Single Wire Parallel connection will be provided as part of configuration.					

Note 1 - $V_{out} = V_{nominal}$. $V_{in} = 395V_{dc}$. $P_{out} = \text{Max Power}$. $T_{amb} = 23\text{degC} \pm 5\text{degC}$ (with 30-minute warm-up period).

ELECTRICAL SPECIFICATIONS

125.0V Module Output Specifications (S1)

Table 19. 125.0V Module in Voltage Source Mode:						
Parameter	Condition	Symbol	Min	Typ	Max	Unit
Nominal Output Voltage	All	V_O	-	125.0	-	Vdc
Output Voltage Adjust Range	All	V_O	6.25	-	150.0	Vdc
Output Line Regulation	All	$\pm V_O$	-	-	125	mV
Output Load Regulation	All	$\pm V_O$	-	-	250	mV
Output Ripple and Noise		V_O	-	-	625	mV _{PK}
Low Frequency RMS Ripple		V_O	-	-	150	mV _{RMS}
Program Accuracy	Digital Analog	$\pm \%V_O$	- -	- -	0.1 1.0	%
Program Resolution		$\pm V_O$	-	6	-	mV
Measure Accuracy		$\pm \%V_O$	-	0.2 ²	-	%
Measure Resolution		$\pm V_O$	-	6	-	mV
V_O Dynamic Response ¹	Peak Deviation Setting Time	50% load change	$\pm \%V_O$ T_s	- -	- -	5 1 % mS
Minimum Dynamic Load	All	I_O	4.8	-	-	A
V_O Long Term Stability Max change over 8 hours	After thermal equilibrium (30 mins)	$\pm \%V_O$	-	-	0.05	%
Temp Coefficient			-	200	-	PPM/°C
Current Sense Method	Internal Shunt					

Note 1 - Test with 560uF capacitor.

Note 2 - 0.2% of set output + 0.2% of nominal output voltage.

ELECTRICAL SPECIFICATIONS

125.0V Module Output Specifications (S1)

Table 20. 125.0V Module in Current Source Mode:						
Parameter	Condition	Symbol	Min	Typ	Max	Unit
Nominal Output Voltage	All	V_o	-	125.0	-	Vdc
Output Current Adjust Range	All	I_o	0	-	24	A
Output Current Ripple		I_o	-	-	24	mA_{RMS}
Output Line Regulation	All	$\pm I_o$	-	-	48	mA
Output Load Regulation	All	$\pm I_o$	-	-	96	mA
Program Accuracy	Digital Analog	$\pm \%I_{o,\text{max}}$	- -	- -	0.7 1.3	%
Program Resolution			-	-	5.2	mA
Measure Accuracy		$\pm \%I_{o,\text{max}}$	-	0.7 ¹	-	%
Measure Resolution		I_o	-	-	5.2	mA
I_o Dynamic Response	Load#1 (Ohm) – Resistive: Equivalent to 110% of Max Power (@ Vnom)	$\pm \%I_o$ T_s	-	-	5	%
	Load#2 (Ohm) – Resistive: Equivalent to 200% of Max Power (@ Vnom)		-	-	20	mS
I_o Long Term Stability Max change over 8 hours	After thermal equilibrium (30 mins)	$\pm \%I_o$	-	-	0.05	%
Temp Coefficient			-	200	-	PPM/°C
Current Sense Method	Internal Shunt					

Note 1 - 0.7% + 0.7% of rated output maximum.

ELECTRICAL SPECIFICATIONS

200.0V Module Output Specifications (SA)

Table 21. 200.0V Module Output General Specifications:						
Parameter	Condition ¹	Symbol	Min	Typ	Max	Unit
Nominal Output Voltage	All	V_o	-	200.0	-	Vdc
Maximum Power	All	P_o	-	-	3000	W
Output Current	All	I_o	0	-	15	A
Load Capacitor	All	C_o	0	-	1300	uF
Power Density	All		-	40.6	-	W/cu-in
Module Input Voltage	All		-	400	-	Vdc
Module Operating Temperature	All		0	-	65	°C
V_o Current Share Accuracy	All	$\pm\%I_{o,max}$	-	-	10	%
Series Operation	80V, 125V, 200V and 250V modules can be connected in series up to 600V for Medical 2MOPP; up to 800V for Medical 2MOOP; up to 1000V for ITE.					
Parallel Operation	Up to 8 modules can be paralleled in 1 rack, with up to 6 racks connected in parallel. Single Wire Parallel connection will be provided as part of configuration.					

Note 1 - $V_{out} = V_{nominal}$. $V_{in} = 395V_{dc}$. $P_{out} = \text{Max Power}$. $T_{amb} = 23\text{degC} \pm 5\text{degC}$ (with 30-minute warm-up period).

ELECTRICAL SPECIFICATIONS

200.0V Module Output Specifications (SA)

Table 22. 200.0V Module in Voltage Source Mode:						
Parameter	Condition	Symbol	Min	Typ	Max	Unit
Nominal Output Voltage	All	V_O	-	200	-	Vdc
Output Voltage Adjust Range	All	V_O	10	-	240	Vdc
Output Line Regulation	All	$\pm V_O$	-	-	200	mV
Output Load Regulation	All	$\pm V_O$	-	-	400	mV
Output Ripple and Noise		V_O	-	-	1250	mV _{PK}
Low Frequency RMS Ripple		V_O	-	-	400	mV _{RMS}
Program Accuracy	Digital Analog	$\pm\%V_O$	- -	- -	0.1 1.0	%
Program Resolution		$\pm V_O$	-	21	-	mV
Measure Accuracy		$\pm\%V_O$	-	0.2 ²	-	%
Measure Resolution		$\pm V_O$	-	21	-	mV
V_O Dynamic Response ¹	Peak Deviation Setting Time	50% load change	$\pm\%V_O$ T_s	- -	- -	5 1 % mS
Minimum Dynamic Load	All	I_O	2.8	-	-	A
V_O Long Term Stability Max change over 8 hours	After thermal equilibrium (30 mins)	$\pm\%V_O$	-	-	0.05	%
Temp Coefficient			-	200	-	PPM/°C
Current Sense Method	Internal Shunt					

Note 1 - Test with 270uF capacitor.

Note 2 - 0.2% of set output + 0.2% of nominal output voltage.

ELECTRICAL SPECIFICATIONS

200.0V Module Output Specifications (SA)

Table 23. 200.0V Module in Current Source Mode:						
Parameter	Condition	Symbol	Min	Typ	Max	Unit
Nominal Output Voltage	All	V_o	-	200	-	Vdc
Output Current Adjust Range	All	I_o	0	-	15	A
Output Current Ripple		I_o	-	-	40	mA_{RMS}
Output Line Regulation	All	$\pm I_o$	-	-	50	mA
Output Load Regulation	All	$\pm I_o$	-	-	56	mA
Program Accuracy	Digital Analog	$\pm \%I_{o,\text{max}}$	- -	- -	0.7 1.3	%
Program Resolution			-	-	2.6	mA
Measure Accuracy		$\pm \%I_{o,\text{max}}$	-	0.7 ¹	-	%
Measure Resolution		I_o	-	-	2.6	mA
I_o Dynamic Response	Load#1 (Ohm) – Resistive: Equivalent to 110% of Max Power (@ Vnom) Load#2 (Ohm) – Resistive: Equivalent to 200% of Max Power (@ Vnom)	$\pm \%I_o$ T_s	- -	- -	5 20	% mS
I_o Long Term Stability Max change over 8 hours	After thermal equilibrium (30 mins)	$\pm \%I_o$	-	-	0.05	%
Temp Coefficient			-	200	-	PPM/°C
Current Sense Method	Internal Shunt					

Note 1 - 0.7% + 0.7% of rated output maximum.

ELECTRICAL SPECIFICATIONS

250.0V Module Output Specifications (S2)

Table 24. 250.0V Module Output General Specifications:						
Parameter	Condition	Symbol	Min	Typ	Max	Unit
Nominal Output Voltage	All	V_o	-	250.0	-	Vdc
Maximum Power	All	P_o	-	-	3000	W
Output Current	All	I_o	0	-	12	A
Load Capacitor	All	C_o	0	-	1300	uF
Power Density	All		-	93.5	-	W/cu-in
Module Input Voltage	All		-	400	-	Vdc
Module Operating Temperature	All		0	-	65	°C
V_o Current Share Accuracy	All	$\pm\%I_{o,max}$	-	-	10	%
Series Operation	80V, 125V, 200V and 250V modules can be connected in series up to 600V for Medical 2MOPP; up to 800V for Medical 2MOOP; up to 1000V for ITE.					
Parallel Operation	Up to 8 modules can be paralleled in 1 rack, with up to 6 racks connected in parallel. Single Wire Parallel connection will be provided as part of configuration.					

ELECTRICAL SPECIFICATIONS

250.0V Module Output Specifications (S2)

Table 25. 250.0V Module in Voltage Source Mode:						
Parameter	Condition	Symbol	Min	Typ	Max	Unit
Nominal Output Voltage	All	V_O	-	250.0	-	Vdc
Output Voltage Adjust Range	All	V_O	12.5	-	300	Vdc
Output Line Regulation	All	$\pm V_O$	-	-	125	mV
Output Load Regulation	All	$\pm V_O$	-	-	250	mV
Output Ripple and Noise		V_O	-	-	1250	mV _{PK}
Low Frequency RMS Ripple		V_O	-	-	150	mV _{RMS}
Program Accuracy	Digital Analog	$\pm \%V_O$	- -	- -	0.1 1.0	%
Program Resolution		$\pm V_O$	-	21	-	mV
Measure Accuracy		$\pm \%V_O$	-	0.2 ²	-	%
Measure Resolution		$\pm V_O$	-	21	-	mV
V_O Dynamic Response ¹	Peak Deviation Setting Time	50% load change	$\pm \%V_O$ T_s	- -	- -	5 1 % mS
Minimum Dynamic Load	All	I_O	2.4	-	-	A
V_O Long Term Stability Max change over 8 hours	After thermal equilibrium (30 mins)	$\pm \%V_O$	-	-	0.05	%
Temp Coefficient			-	200	-	PPM/°C
Current Sense Method	Internal Shunt					

Note 1 - Test with 270uF capacitor.

Note 2 - 0.2% of set output + 0.2% of nominal output voltage.

ELECTRICAL SPECIFICATIONS

250.0V Module Output Specifications (S2)

Table 26. 250.0V Module in Current Source Mode:						
Parameter	Condition	Symbol	Min	Typ	Max	Unit
Nominal Output Voltage	All	V_o	-	250.0	-	Vdc
Output Current Adjust Range	All	I_o	0	-	12	A
Output Current Ripple		I_o	-	-	12	mA_{RMS}
Output Line Regulation	All	$\pm I_o$	-	-	24	mA
Output Load Regulation	All	$\pm I_o$	-	-	48	mA
Program Accuracy	Digital Analog	$\pm \%I_{o,max}$	- -	- -	0.7 1.3	%
Program Resolution			-	-	2.6	mA
Measure Accuracy		$\pm \%I_{o,max}$	-	0.7 ¹	-	%
Measure Resolution		I_o	-	-	2.6	mA
I_o Dynamic Response	Load#1 (Ohm) – Resistive: Equivalent to 110% of Max Power (@ Vnom) Load#2 (Ohm) – Resistive: Equivalent to 200% of Max Power (@ Vnom)	$\pm \%I_o$ T_s	- -	- -	5 20	% mS
I_o Long Term Stability Max change over 8 hours	After thermal equilibrium (30 mins)	$\pm \%I_o$	-	-	0.05	%
Temp Coefficient			-	200	-	PPM/°C
Current Sense Method	Internal Shunt					

Note 1 - 0.7% + 0.7% of rated output maximum.

ELECTRICAL SPECIFICATIONS

50.0V Module Output Specifications (TW)

Table 27. 50.0V Module Output General Specifications:						
Parameter	Condition	Symbol	Min	Typ	Max	Unit
Nominal Output Voltage	All	V_o	-	50.0	-	Vdc
Maximum Power	All	P_o	-	-	12000	W
Output Current	All	I_o	0	-	270 ¹	A
Load Capacitor	All	C_o	0	-	22000	uF
Power Density (W/cu-in)	All		-	TBA	-	W/cu-in
Module Input Voltage	All		-	400	-	Vdc
Module Operating Temperature	All		0	-	65	°C
V_o Current Share Accuracy	All	$\pm\%I_{o,max}$	-	-	10	%
Series Operation	No series operation offering					
Parallel Operation	Up to 2 modules can be paralleled in 1 rack, with up to 6 racks connected in parallel. Single Wire Parallel connection will be provided as part of configuration.					

ELECTRICAL SPECIFICATIONS

50.0V Module Output Specifications (TW)

Table 28. 50.0V Module in Voltage Source Mode:							
Parameter	Condition	Symbol	Min	Typ	Max	Unit	
Nominal Output Voltage	All	V_O	-	50.0	-	Vdc	
Output Voltage Adjust Range	All	V_O	2.5	-	60	Vdc	
Output Line Regulation	All	$\pm V_O$	-	-	50	mV	
Output Load Regulation	All	$\pm V_O$	-	-	100	mV	
Output Ripple and Noise		V_O	-	-	250	mV _{PK}	
Low Frequency RMS Ripple		V_O	-	-	100	mV _{RMS}	
Program Accuracy ¹	Digital Analog	$\pm\%V_O$	- -	- -	0.1 1.0	%	
Program Resolution		$\pm V_O$	-	2	-	mV	
Measure Accuracy		$\pm\%V_O$	-	0.2 ²	-	%	
Measure Resolution		$\pm V_O$	-	TBA	-	mV	
V_O Dynamic Response ³	Peak Deviation Setting Time	50% load change	$\pm\%V_O$ T_s	- -	- -	5 1	% mS
Minimum Dynamic Load	All	I_O	60	-	-	A	
V_O Long Term Stability Max change over 8 hours	After thermal equilibrium (30 mins)	$\pm\%V_O$	-	-	0.05	%	
Temp Coefficient			-	200	-	PPM/°C	
Current Sense Method	Internal Shunt						

Note 1 - Digital: 0.1% of Normal Output Voltage; Analog: 1.0% of normal Output Voltage.

Note 2 - 0.2% of set output + 0.2% of nominal output voltage.

Note 3 - Test with 6800uF capacitor.

ELECTRICAL SPECIFICATIONS

50.0V Module Output Specifications (TW)

Table 29. 50.0V Module in Current Source Mode:						
Parameter	Condition	Symbol	Min	Typ	Max	Unit
Nominal Output Voltage	All	V_o	-	50.0	-	Vdc
Output Current Adjust Range	All	I_o	0	-	270	A
Output Current Ripple		I_o	-	-	270	mA_{RMS}
Output Line Regulation	All	$\pm I_o$	-	-	270	mA
Output Load Regulation	All	$\pm I_o$	-	-	1200	mA
Program Accuracy ¹	Digital Analog	$\pm \%I_{o,max}$	- -	- -	0.7 1.3	%
Program Resolution			-	-	20	mA
Measure Accuracy		$\pm \%I_{o,max}$	-	0.7 ²	-	%
Measure Resolution		I_o	-	-	TBA	mA
I_o Dynamic Response	Load#1 (Ohm) – Resistive: Equivalent to 110% of Max Power (@ Vnom) Load#2 (Ohm) – Resistive: Equivalent to 200% of Max Power (@ Vnom)	$\pm \%I_o$ T_s	- -	- -	5 20	% mS
I_o Long Term Stability Max change over 8 hours	After thermal equilibrium (30 mins)	$\pm \%I_o$	-	-	0.05	%
Temp Coefficient			-	300	-	PPM/°C
Current Sense Method	Internal Shunt					

Note 1 - Digital: 0.7% of Normal Output Voltage; Analog: 1.3% of normal Output Voltage.

Note 2 - 0.7% + 0.7% of rated output Maximum.

Note 3 - Test with 6800uF capacitor.

ELECTRICAL SPECIFICATIONS

300.0V Module Output Specifications (T3)

Table 30. 300.0V Module Output General Specifications:						
Parameter	Condition	Symbol	Min	Typ	Max	Unit
Nominal Output Voltage	All	V_o	-	300.0	-	Vdc
Maximum Power	All	P_o	-	-	12000	W
Output Current	All	I_o	0	-	50	A
Load Capacitor	All	C_o	0	-	1800	uF
Power Density (W/cu-in)	All		-	TBA	-	W/cu-in
Module Input Voltage	All		-	400	-	Vdc
Module Operating Temperature	All		0	-	65	°C
V_o Current Share Accuracy	All	$\pm\%I_{o,max}$	-	-	10	%
Series Operation	No series operation offering					
Parallel Operation	Up to 2 modules can be paralleled in 1 rack, with up to 6 racks connected in parallel. Single Wire Parallel connection will be provided as part of configuration.					

ELECTRICAL SPECIFICATIONS

300.0V Module Output Specifications (T3)

Table 31. 300.0V Module in Voltage Source Mode:						
Parameter	Condition	Symbol	Min	Typ	Max	Unit
Nominal Output Voltage	All	V_O	-	300.0	-	Vdc
Output Voltage Adjust Range	All	V_O	15	-	360	Vdc
Output Line Regulation	All	$\pm V_O$	-	-	300	mV
Output Load Regulation	All	$\pm V_O$	-	-	600	mV
Output Ripple and Noise		V_O	-	-	1500	mV _{PK}
Low Frequency RMS Ripple		V_O	-	-	600	mV _{RMS}
Program Accuracy ¹	Digital Analog	$\pm \%V_O$	- -	- -	0.1 1.0	%
Program Resolution		$\pm V_O$	-	TBA	-	mV
Measure Accuracy		$\pm \%V_O$	-	0.2 ²	-	%
Measure Resolution		$\pm V_O$	-	TBA	-	mV
V_O Dynamic Response ³	Peak Deviation Setting Time	50% load change	$\pm \%V_O$ T_s	- -	- -	5 1 % mS
Minimum Dynamic Load	All	I_O	10	-	-	A
V_O Long Term Stability Max change over 8 hours	After thermal equilibrium (30 mins)	$\pm \%V_O$	-	-	0.05	%
Temp Coefficient			-	200	-	PPM/°C
Current Sense Method	Internal Shunt; External Shunt can be used for better temperature stability.					

Note 1 - Digital: 0.1% of Normal Output Voltage; Analog: 1.0% of normal Output Voltage.

Note 2 - 0.2% of set output + 0.2% of nominal output voltage.

Note 3 - Test with 1200uF capacitor.

ELECTRICAL SPECIFICATIONS

300.0V Module Output Specifications (T3)

Table 32. 300.0V Module in Current Source Mode:						
Parameter	Condition	Symbol	Min	Typ	Max	Unit
Nominal Output Voltage	All	V_o	-	300.0	-	Vdc
Output Current Adjust Range	All	I_o	0	-	50	A
Output Current Ripple		I_o	-	-	50	mA_{RMS}
Output Line Regulation	All	$\pm I_o$	-	-	100	mA
Output Load Regulation	All	$\pm I_o$	-	-	200	mA
Program Accuracy ¹	Digital Analog	$\pm \%I_{o,\text{max}}$	- -	- -	0.7 1.3	%
Program Resolution			-	-	TBA	mA
Measure Accuracy		$\pm \%I_{o,\text{max}}$	-	0.7 ²	-	%
Measure Resolution		I_o	-	-	TBA	mA
I_o Dynamic Response	Load#1 (Ohm) – Resistive: Equivalent to 110% of Max Power (@ Vnom) Load#2 (Ohm) – Resistive: Equivalent to 200% of Max Power (@ Vnom)	$\pm \%I_o$ T_s	- -	- -	5 20	% mS
I_o Long Term Stability Max change over 8 hours	After thermal equilibrium (30 mins)	$\pm \%I_o$	-	-	0.05	%
Temp Coefficient			-	200	-	PPM/°C
Current Sense Method	Internal Shunt					

Note 1 - Digital: 0.7% of Normal Output Voltage; Analog: 1.3% of normal Output Voltage.

Note 2 - 0.7% + 0.7% of rated output Maximum.

ELECTRICAL SPECIFICATIONS

System Timing Specifications

Table 33. System Timing Specifications					
Label	Parameter	Min	Typ	Max	Unit
T1	Delay from AC being applied to V_{SB} being within regulation	2	-	500	mSec
T2	Delay from V_{SB} output to main output voltage V_O being within regulation	-	-	20	Sec
T3	Delay from V_{SB} output to AC OK assertion	-	-	800	mSec
T4	Delay from AC being applied to output voltages being within regulation with Global Enable asserted low.	-	-	21	Sec
T5	Delay from output voltages within regulation limits to Global DC OK asserted high.	100	-	1000	mSec
T6	Delay from loss of AC to standby output remain within regulation	150	-	-	mSec
T7	Delay from loss of AC input to ACOK going to low	-	-	10	mSec
T8	Hold up time - Delay from loss of AC to main output remain within regulation	21	-	-	mSec
T9	Delay from loss of AC to de-assertion of Global DC OK	20	-	-	mSec
T10	Delay from Global DC OK de-asserted to output voltages dropping out of regulation limits	1	-	-	mSec
T11	Delay from Global Enable active to output voltages within regulation limits	-	-	350	mSec

ELECTRICAL SPECIFICATIONS

System Timing Diagram

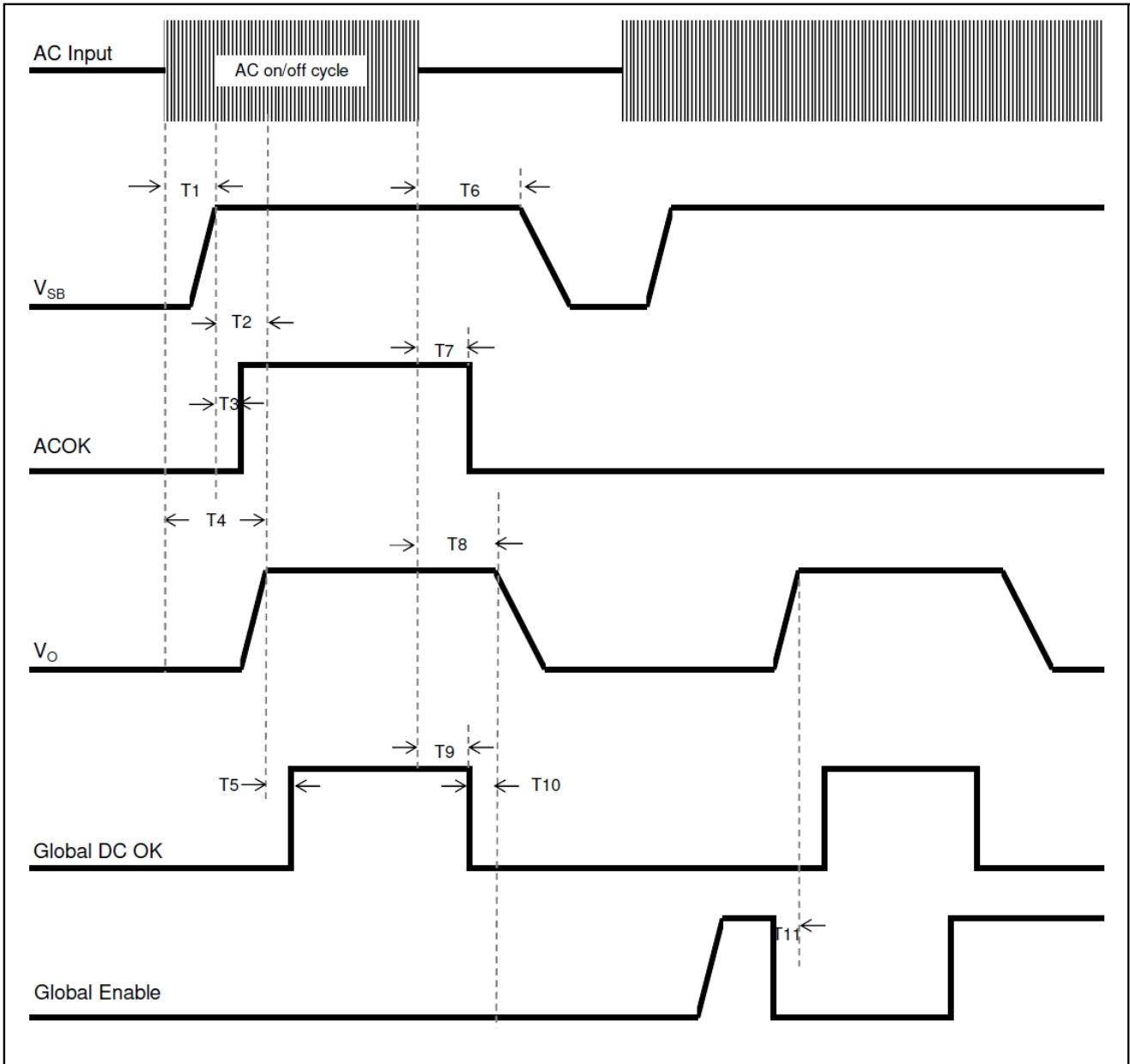

ELECTRICAL SPECIFICATIONS

iHP24 Case Performance Curves

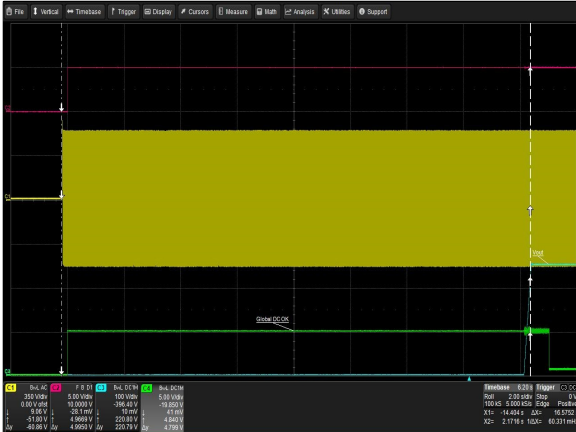

Figure 1: iHP24H3A-S2-00 Turn-on delay via AC mains
 Vin = 380Vac Load: $I_o = 12A$ $I_{SB} = 1A$
 Ch 1: AC Mains Ch 2: V_{SB} Ch 3: V_o Ch 4: Global DCOK

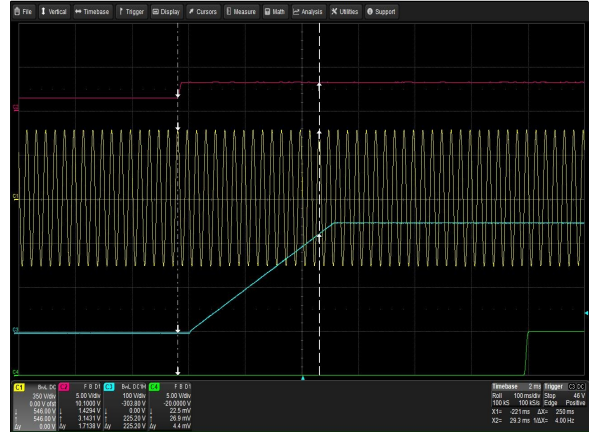

Figure 2: iHP24H3A-S2-00 Turn-on delay via Global inhibit
 Vin = 380Vac Load: $I_o = 12A$ $I_{SB} = 1A$
 Ch 1: AC Mains Ch 2: Global inhibit Ch 3: V_o Ch 4: Global DCOK

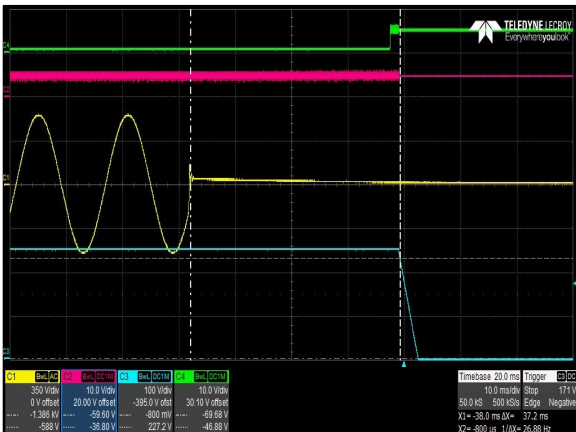

Figure 3: iHP24H3A-S2-00 Hold-up Time
 Vin = 380Vac/63Hz/0° Load: $I_o = 12A$ $I_{SB} = 1A$
 Ch 1: AC Mains Ch 2: V_{SB} Ch 3: V_o Ch 4: Global DCOK

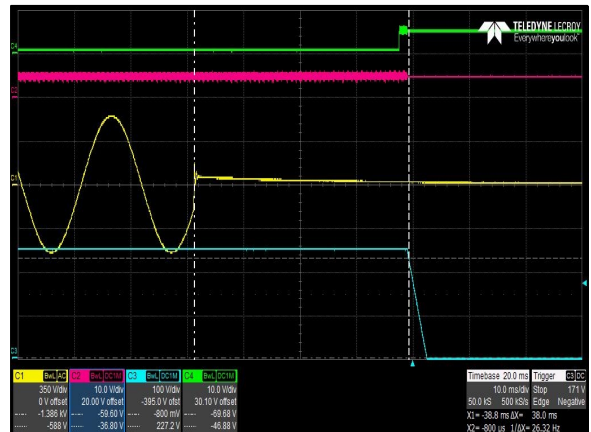

Figure 4: iHP24H3A-S2-00 Hold-up Time
 Vin = 380Vac/47Hz/0° Load: $I_o = 12A$ $I_{SB} = 1A$
 Ch 1: AC Mains Ch 2: V_{SB} Ch 3: V_o Ch 4: Global DCOK

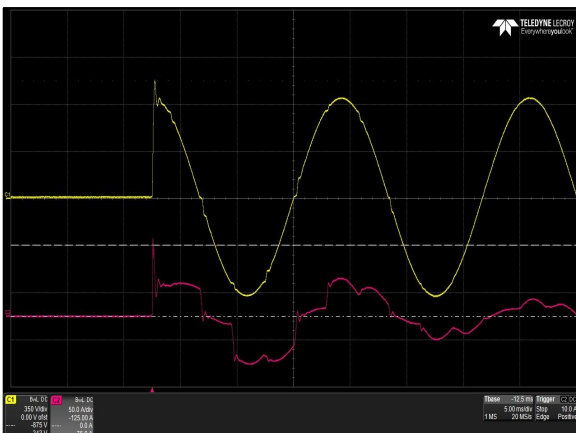

Figure 5: iHP24H3A-S2-00 Start up Inrush Current
 Vin = 528Vac Load: $I_o = 0A$ Turn On Phase = 90°
 Ch 1: V_{IN} Ch 2: I_{IN}

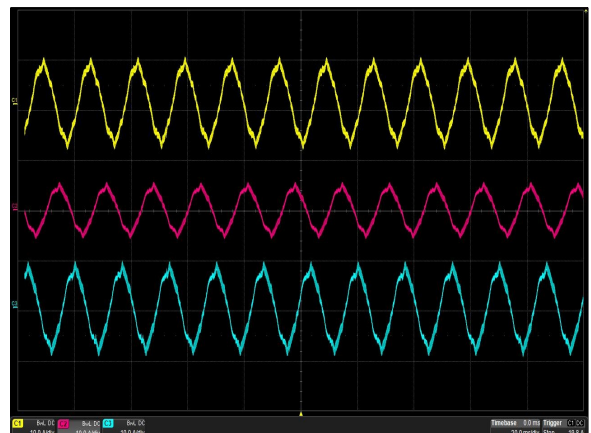
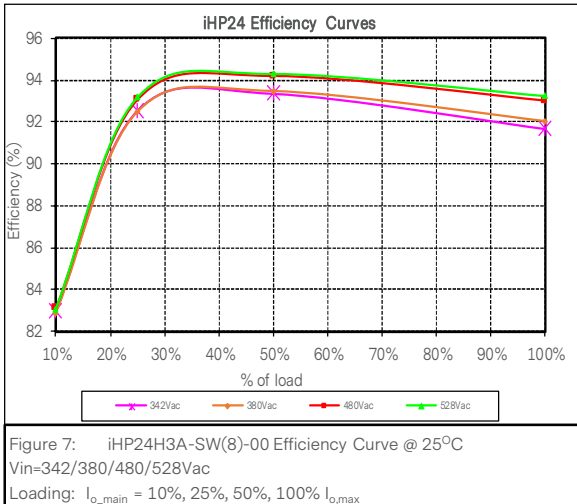

Figure 6: iHP24H3A-S2-00 Input Current Waveform
 Vin = 380Vac Load: $I_o = 12A$ $I_{SB} = 1A$
 Ch 1: Line 1 Ch 2: Line 2 Ch 3: Line 3

ELECTRICAL SPECIFICATIONS

iHP24 Case Performance Curves



ELECTRICAL SPECIFICATIONS

iHP12 Case Performance Curves

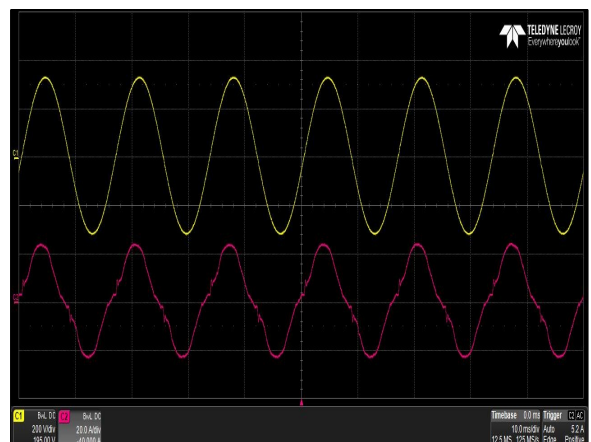
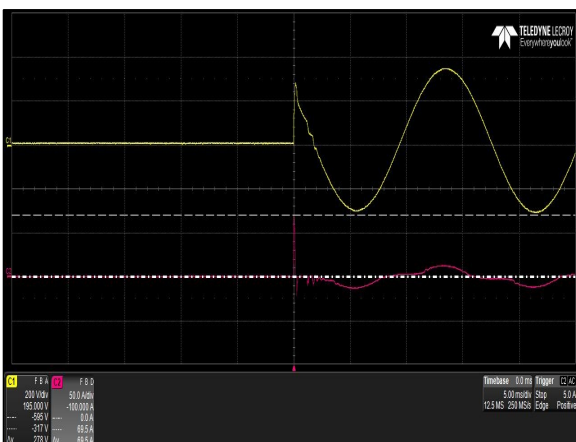
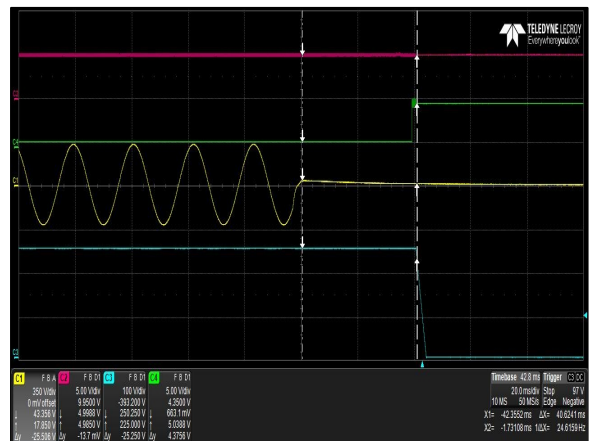
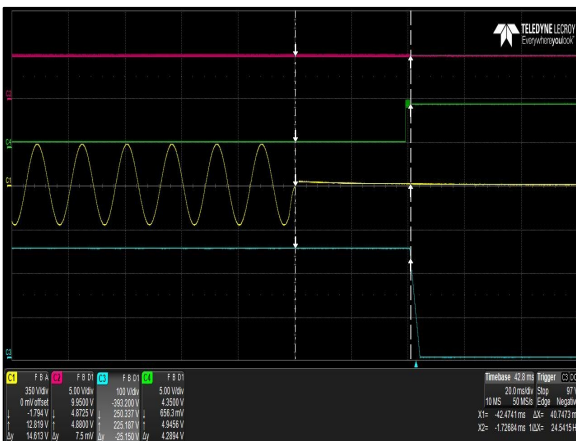
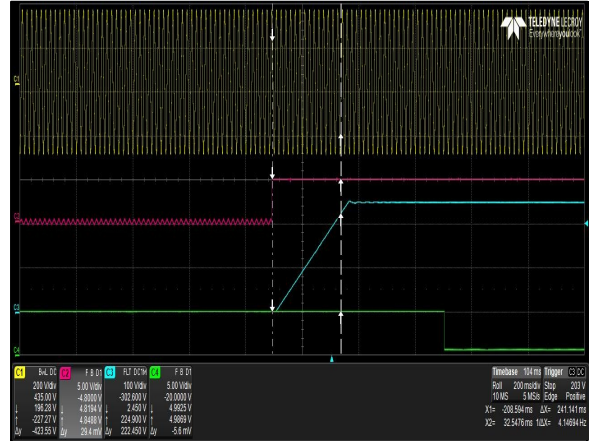
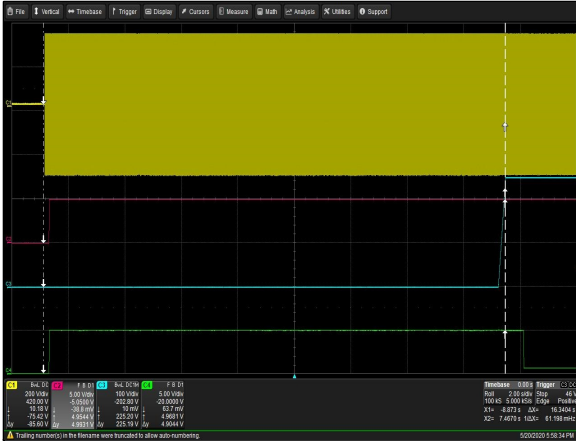

ELECTRICAL SPECIFICATIONS

iHP12 Case Performance Curves

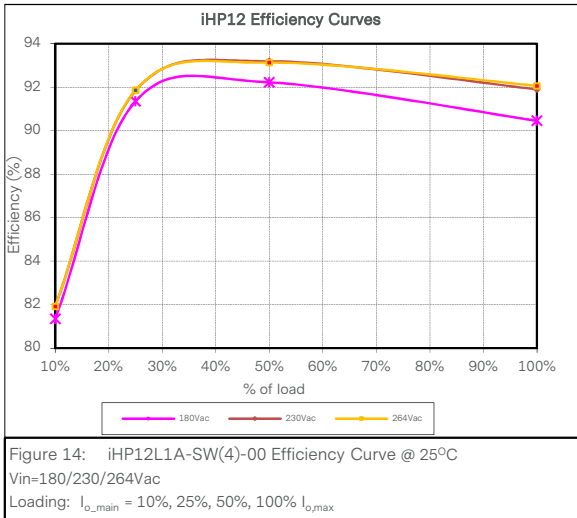

ELECTRICAL SPECIFICATIONS

250V 3000W Module (S2) Performance Curves - Constant Voltage Mode

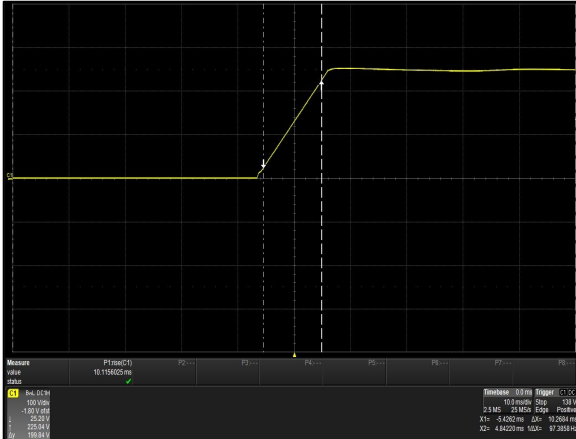

Figure 15: iHP24H3A-S2-00 Output Voltage Startup Characteristic
Load: $I_o = 12A$
Ch 1: V_o

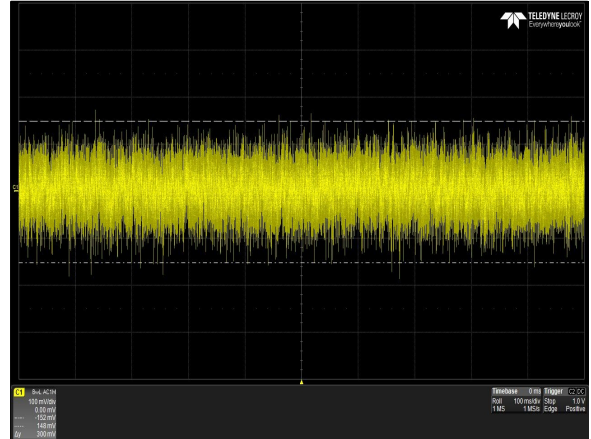

Figure 16: iHP24H3A-S2-00 Ripple and Noise Measurement
Load: $I_o = 4A$
Ch 1: V_o

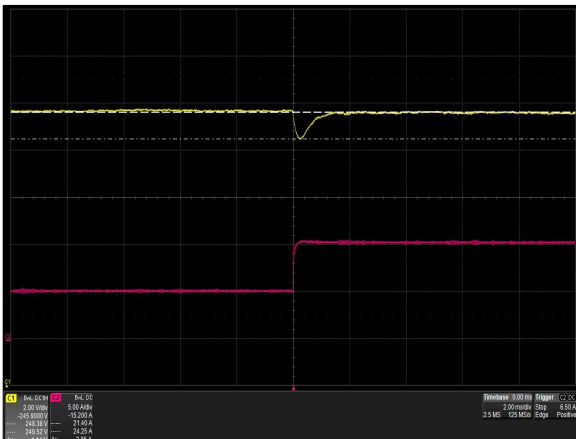

Figure 17: iHP24H3A-S2-00 Transient Response - V_o Deviation
50% to 100% load change, $0.5A/\mu S$ slew rate
Ch 1: V_o Ch 2: I_o

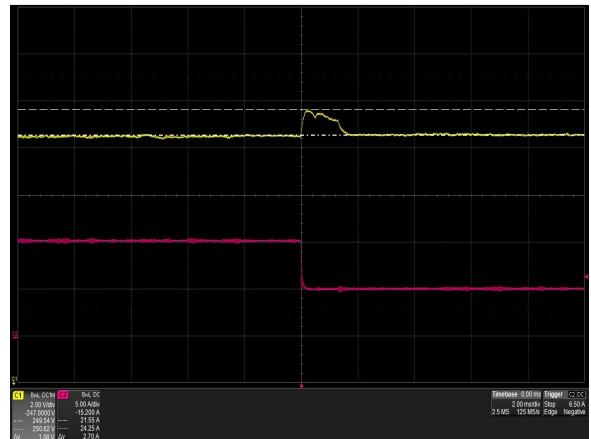

Figure 18: iHP24H3A-S2-00 Transient Response - V_o Deviation
100% to 50% load change, $0.5A/\mu S$ slew rate
Ch 1: V_o Ch 2: I_o

ELECTRICAL SPECIFICATIONS

250V 3000W Module (S2) Performance Curves - Constant Current Mode

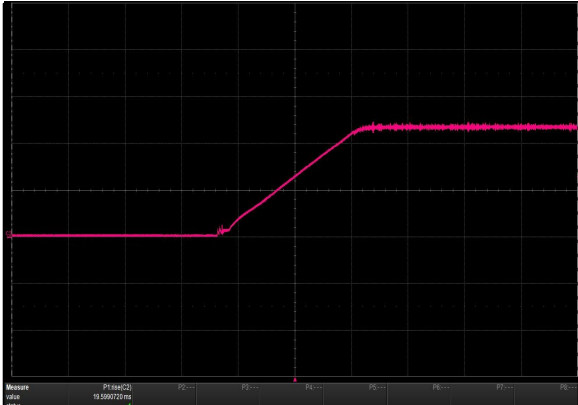

Figure 19: iHP24H3A-S2-00 Output Voltage Startup Characteristic
 Load: R = 20.8 ohm
 Ch 2: I_o

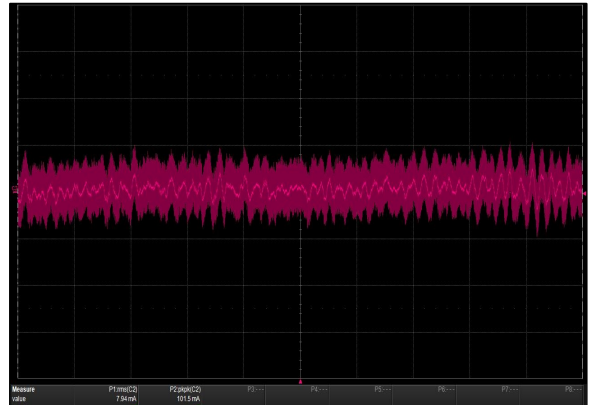

Figure 20: iHP24H3A-S2-00 Ripple and Noise Measurement
 Load: R = 20.8 ohm
 Ch 2: I_o

ELECTRICAL SPECIFICATIONS

200V 3000W Module (SA) Performance Curves - Constant Voltage Mode

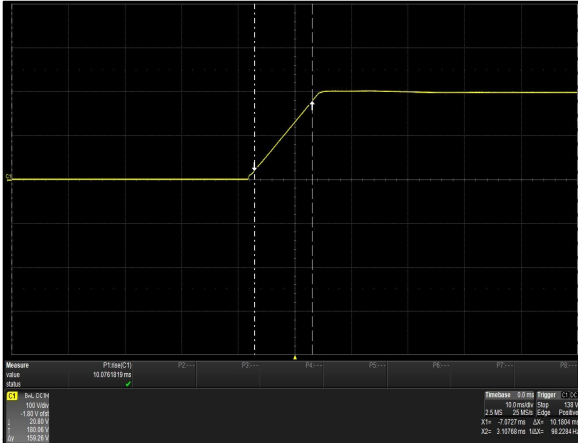

Figure 21: iHP24H3A-SA-00 Output Voltage Startup Characteristic
Load: $I_o = 15A$
Ch 1: V_o

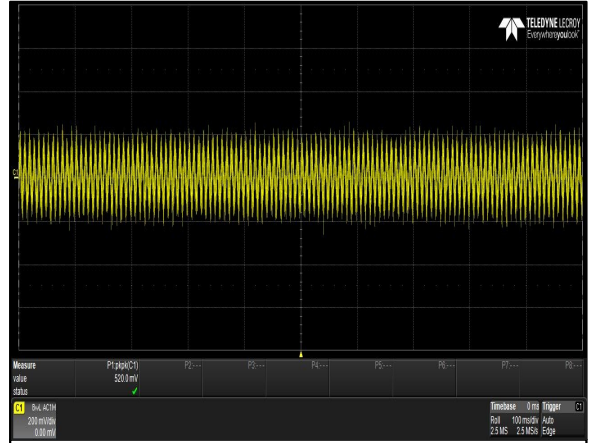

Figure 22: iHP24H3A-SA-00 Ripple and Noise Measurement
Load: $I_o = 15A$
Ch 1: V_o

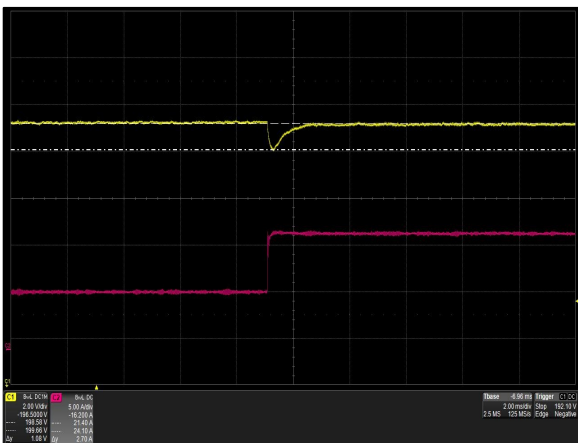

Figure 23: iHP24H3A-SA-00 Transient Response - V_o Deviation
50% to 100% load change, 0.5A/ μ S slew rate
Ch 1: V_o Ch 2: I_o

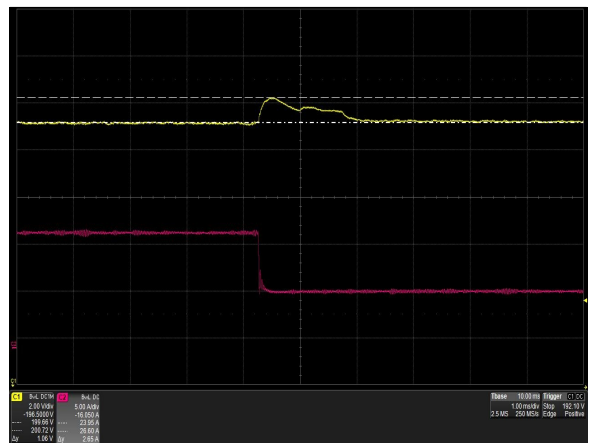

Figure 24: iHP24H3A-SA-00 Transient Response - V_o Deviation
100% to 50% load change, 0.5A/ μ S slew rate
Ch 1: V_o Ch 2: I_o

ELECTRICAL SPECIFICATIONS

200V 3000W Module (SA) Performance Curves - Constant Current Mode

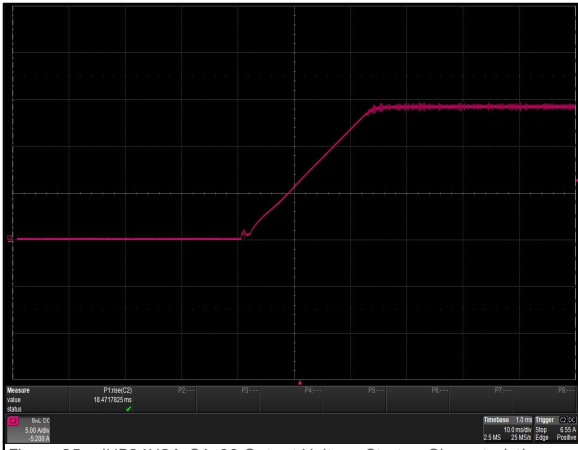

Figure 25: iHP24H3A-SA-00 Output Voltage Startup Characteristic
 Load: R = 13.3 ohm
 Ch 2: I_o

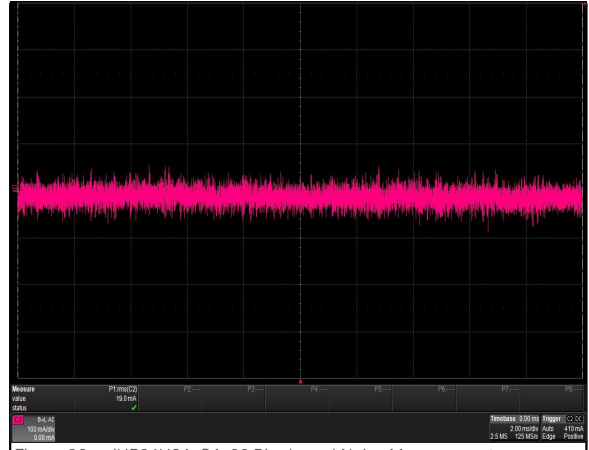

Figure 26: iHP24H3A-SA-00 Ripple and Noise Measurement
 Load: R = 13.3 ohm
 Ch 2: I_o

ELECTRICAL SPECIFICATIONS

125V 3000W Module (S1) Performance Curves - Constant Voltage Mode

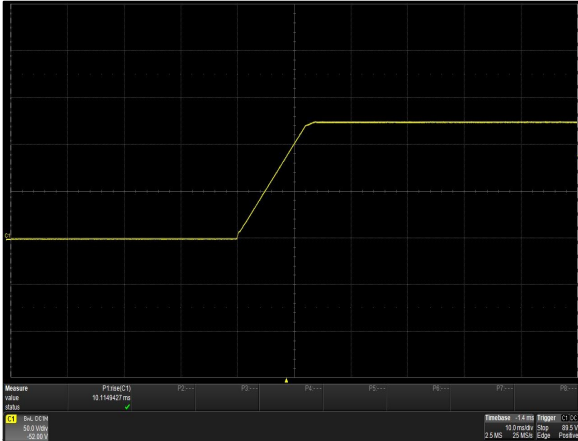

Figure 27: iHP24H3A-S1-00 Output Voltage Startup Characteristic
Load: $I_o = 12A$
Ch 1: V_o

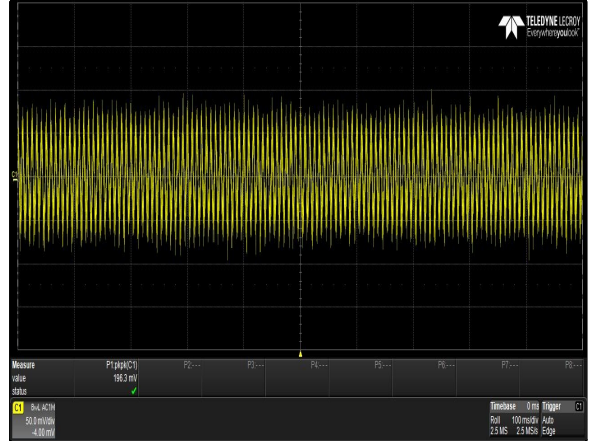

Figure 28: iHP24H3A-S1-00 Ripple and Noise Measurement
Load: $I_o = 4A$
Ch 1: V_o

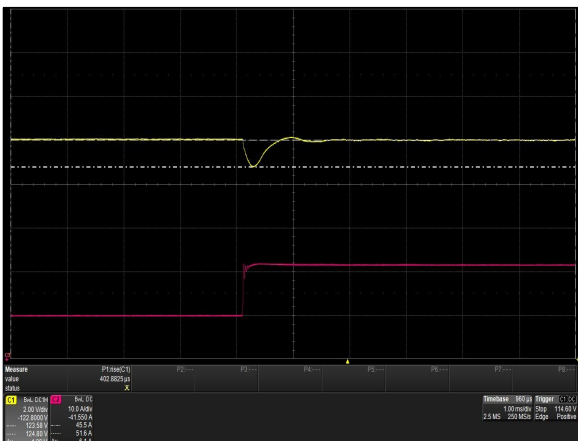

Figure 29: iHP24H3A-S1-00 Transient Response - V_o Deviation
50% to 100% load change, 0.5A/ μ S slew rate
Ch 1: V_o Ch 2: I_o

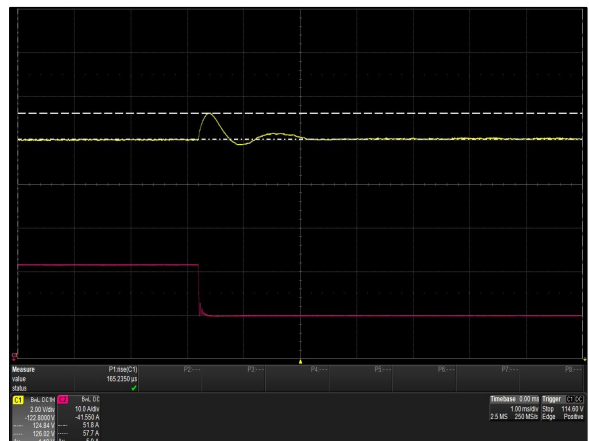

Figure 30: iHP24H3A-S1-00 Transient Response - V_o Deviation
100% to 50% load change, 0.5A/ μ S slew rate
Ch 1: V_o Ch 2: I_o

ELECTRICAL SPECIFICATIONS

125V 3000W Module (S1) Performance Curves - Constant Current Mode

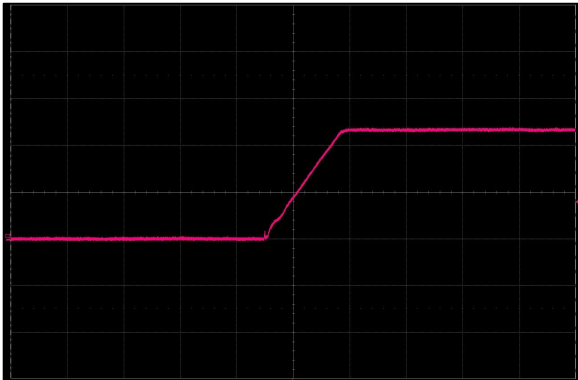

Figure 31: iHP24H3A-S1-00 Output Voltage Startup Characteristic
 Load: R = 5.2 ohm
 Ch 2: I_o

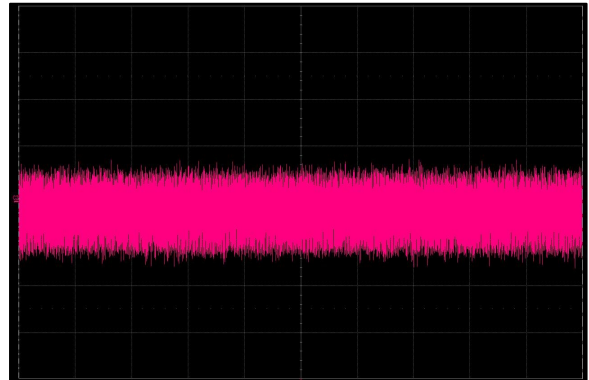

Figure 32: iHP24H3A-S1-00 Ripple and Noise Measurement
 Load: R = 5.2 ohm
 Ch 2: I_o

ELECTRICAL SPECIFICATIONS

80V 3000W Module (S8) Performance Curves - Constant Voltage Mode

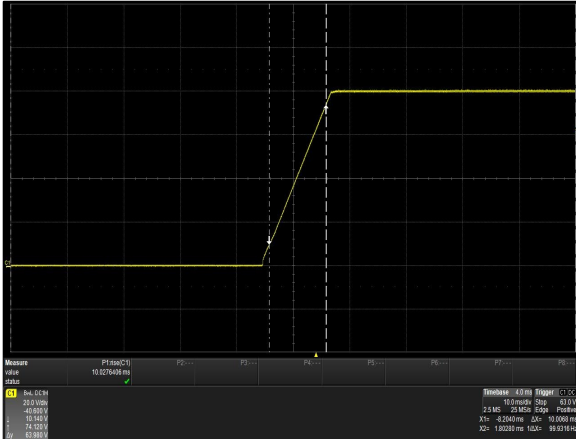

Figure 33: iHP24H3A-S8-00 Output Voltage Startup Characteristic
Load: $I_o = 37.5A$
Ch 1: V_o

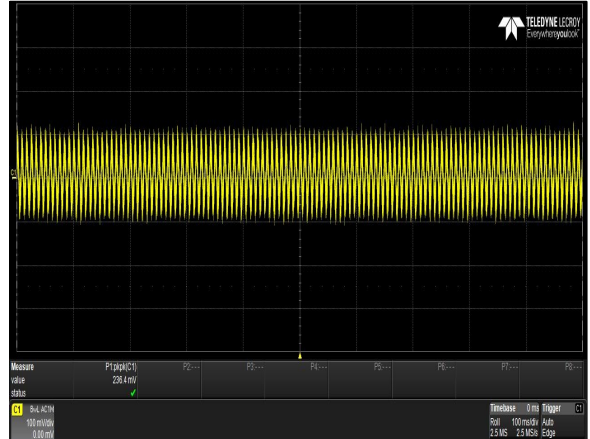

Figure 34: iHP24H3A-S8-00 Ripple and Noise Measurement
Load: $I_o = 37.5A$
Ch 1: V_o

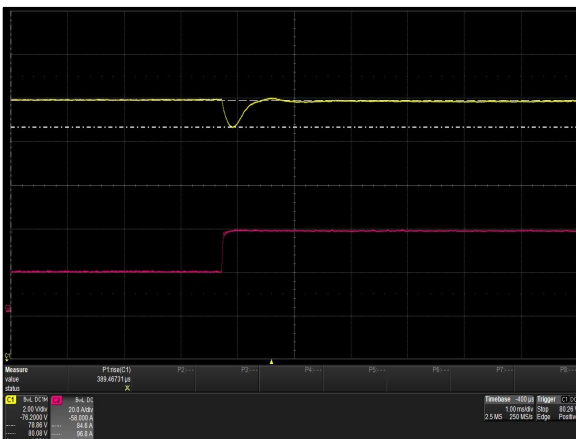

Figure 35: iHP24H3A-S8-00 Transient Response - V_o Deviation
50% to 100% load change, $0.5A/\mu S$ slew rate
Ch 1: V_o Ch 2: I_o

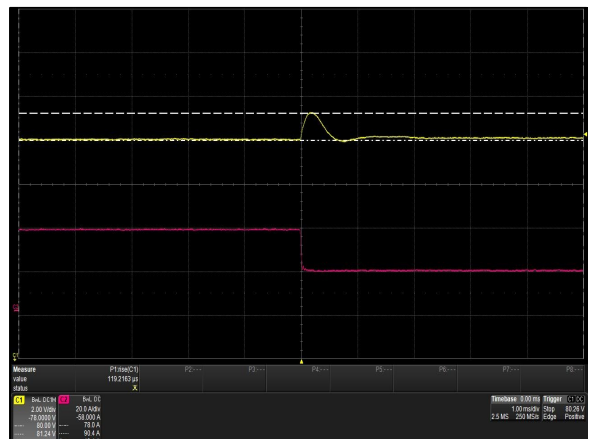

Figure 36: iHP24H3A-S8-00 Transient Response - V_o Deviation
100% to 50% load change, $0.5A/\mu S$ slew rate
Ch 1: V_o Ch 2: I_o

ELECTRICAL SPECIFICATIONS

80V 3000W Module (S8) Performance Curves - Constant Current Mode

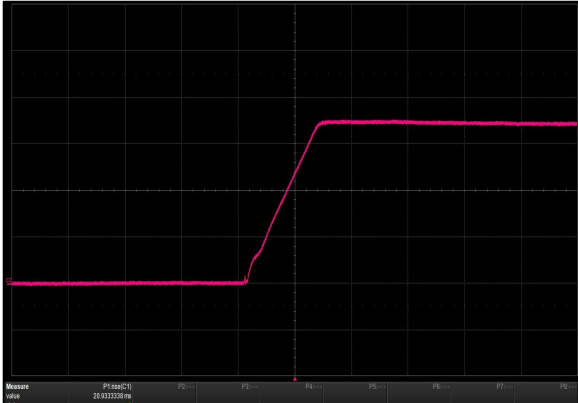

Figure 37: iHP24H3A-S1-00 Output Voltage Startup Characteristic
 Load: R = 2.13 ohm
 Ch 2: I_o

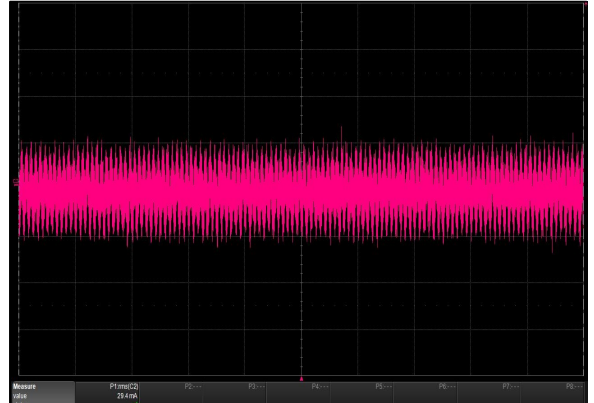

Figure 38: iHP24H3A-S1-00 Ripple and Noise Measurement
 Load: R = 2.13 ohm
 Ch 2: I_o

ELECTRICAL SPECIFICATIONS

48V 3000W Module (SW) Performance Curves - Constant Voltage Mode

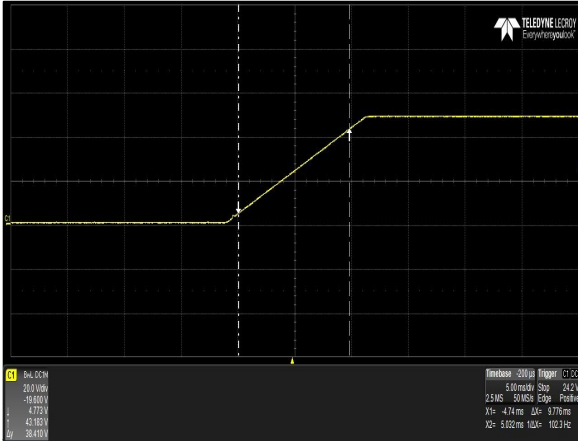

Figure 39: iHP24H3A-SW-00 Output Voltage Startup Characteristic
Load: $I_o = 62.5A$
Ch 1: V_o

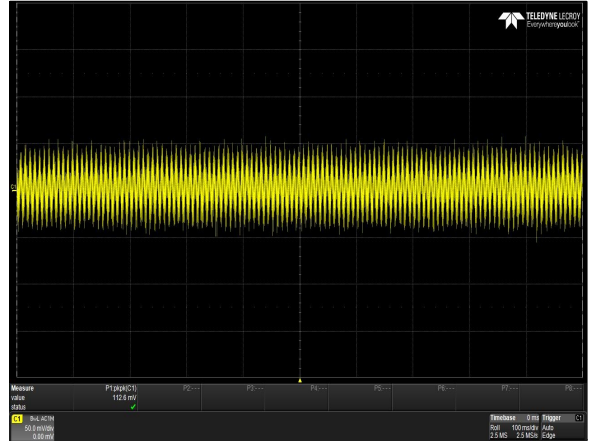

Figure 40: iHP24H3A-SW-00 Ripple and Noise Measurement
Load: $I_o = 62.5A$
Ch 1: V_o

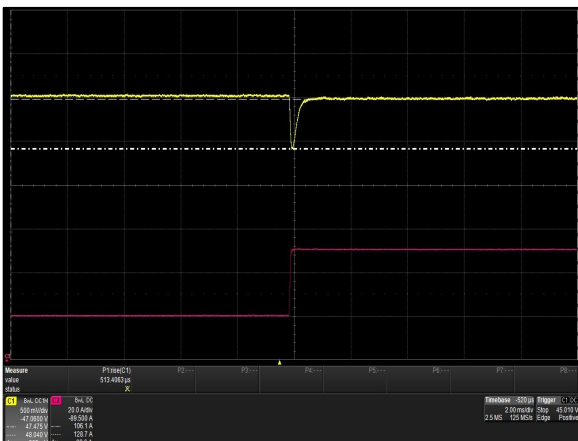

Figure 41: iHP24H3A-SW-00 Transient Response - V_o Deviation
50% to 100% load change, $0.5A/\mu S$ slew rate
Ch 1: V_o Ch 2: I_o

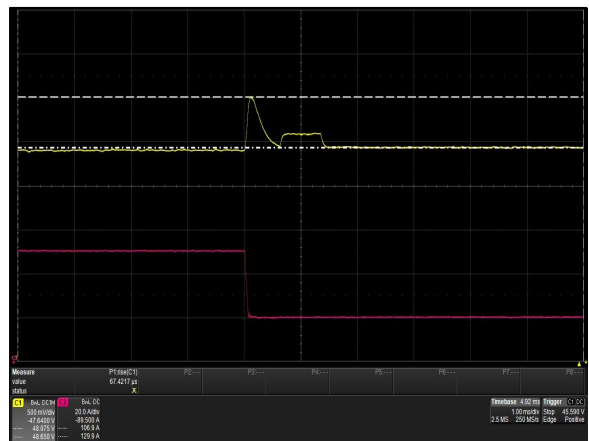

Figure 42: iHP24H3A-SW-00 Transient Response - V_o Deviation
100% to 50% load change, $0.5A/\mu S$ slew rate
Ch 1: V_o Ch 2: I_o

ELECTRICAL SPECIFICATIONS

48V 3000W Module (SW) Performance Curves - Constant Current Mode

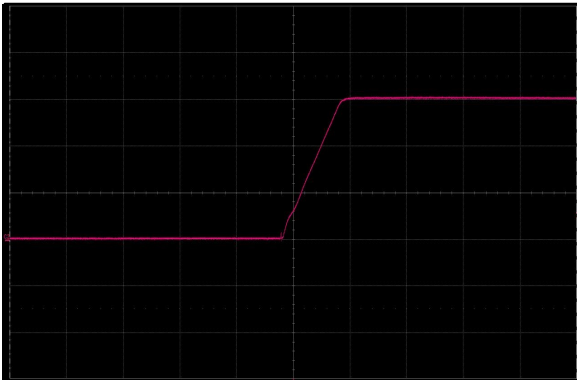

Figure 43: iHP24H3A-SW-00 Output Voltage Startup Characteristic
 Load: R = 0.768 ohm
 Ch 2: I_o

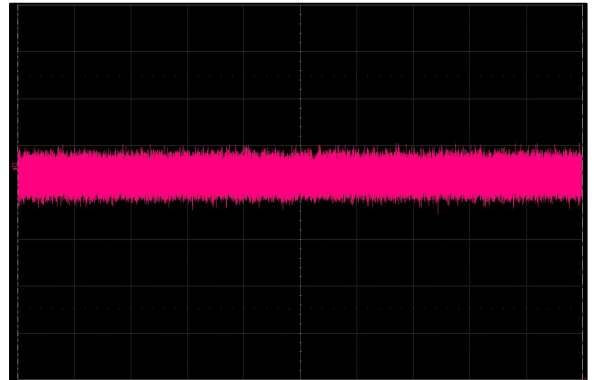

Figure 44: iHP24H3A-SW-00 Ripple and Noise Measurement
 Load: R = 0.768 ohm
 Ch 2: I_o

ELECTRICAL SPECIFICATIONS

32V 2880W Module (ST) Performance Curves - Constant Voltage Mode

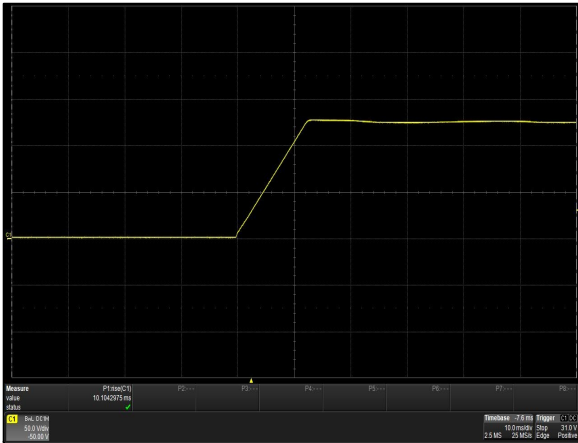

Figure 45: iHP24H3A-ST-00 Output Voltage Startup Characteristic
Load: $I_o = 90A$
Ch 1: V_o

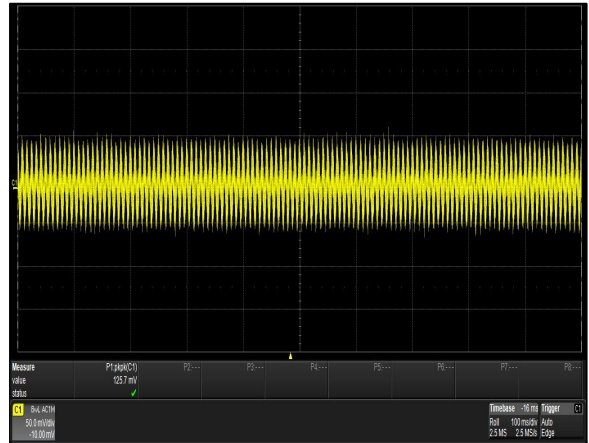

Figure 46: iHP24H3A-ST-00 Ripple and Noise Measurement
Load: $I_o = 90A$
Ch 1: V_o

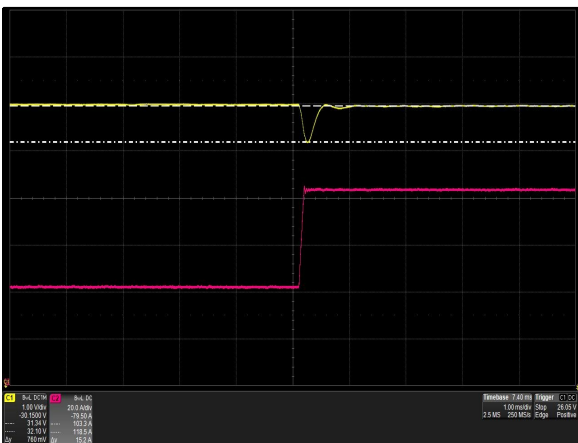

Figure 47: iHP24H3A-ST-00 Transient Response - V_o Deviation
50% to 100% load change, $0.5A/\mu S$ slew rate
Ch 1: V_o Ch 2: I_o

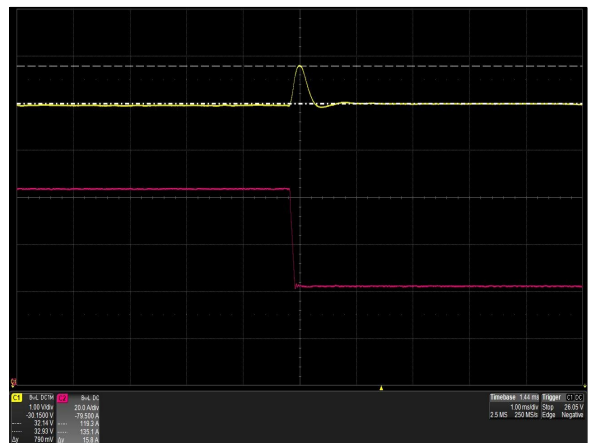

Figure 48: iHP24H3A-ST-00 Transient Response - V_o Deviation
100% to 50% load change, $0.5A/\mu S$ slew rate
Ch 1: V_o Ch 2: I_o

ELECTRICAL SPECIFICATIONS

24V 2880W Module (SQ) Performance Curves - Constant Voltage Mode

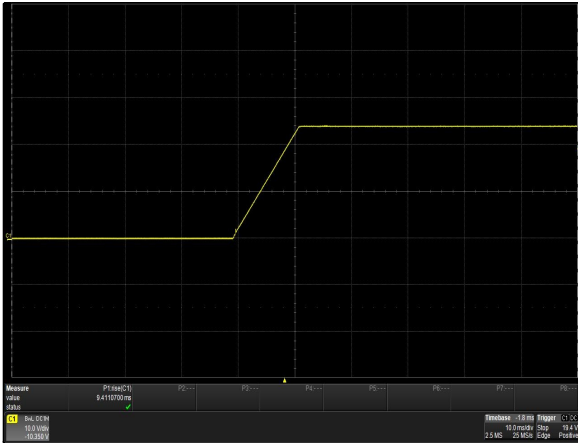

Figure 51: iHP24H3A-SQ-00 Output Voltage Startup Characteristic
Load: $I_o = 120A$
Ch 1: V_o

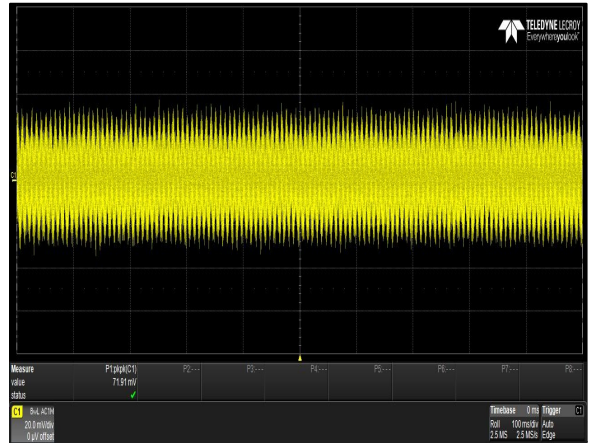

Figure 52: iHP24H3A-SQ-00 Ripple and Noise Measurement
Load: $I_o = 120A$
Ch 1: V_o

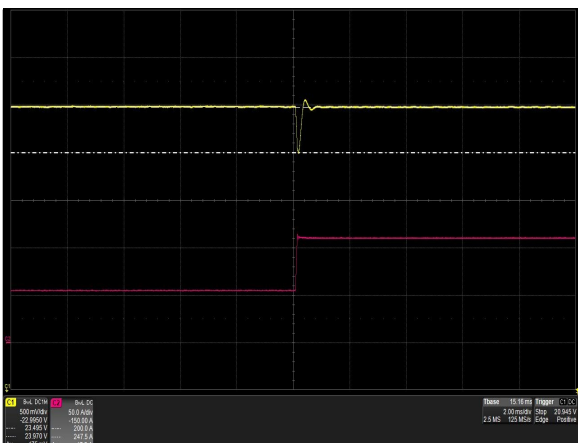

Figure 53: iHP24H3A-SQ-00 Transient Response - V_o Deviation
50% to 100% load change, $0.5A/\mu S$ slew rate
Ch 1: V_o Ch 2: I_o

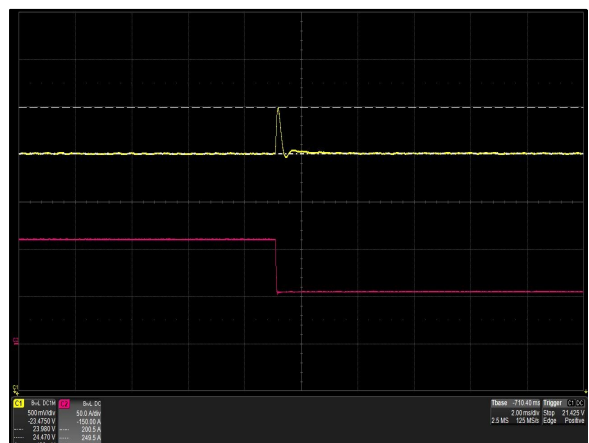
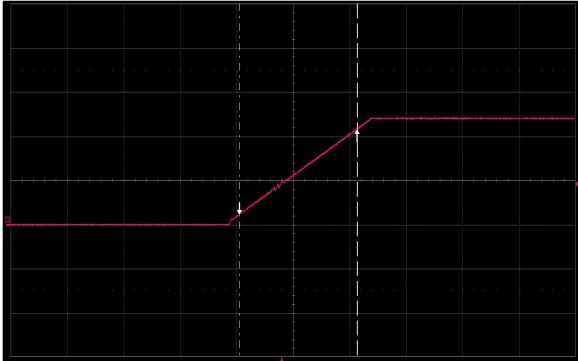

Figure 54: iHP24H3A-SQ-00 Transient Response - V_o Deviation
100% to 50% load change, $0.5A/\mu S$ slew rate
Ch 1: V_o Ch 2: I_o

ELECTRICAL SPECIFICATIONS

24V 2880W Module (SQ) Performance Curves - Constant Current Mode



84.00 50.0 A/div 25.0 ns 25.0 ns 25.0 ns 25.0 ns 25.0 ns 25.0 ns 25.0 ns 25.0 ns
 Timebase: 2.0 ms Trigger: \square 00
 10.000000 Stop 47.0 A
 2.5 MS 25 MS 500
 X1= 7.500 ms X2= 20.07 ms
 X3= 13.37 ms X4= 47.91 Hz

Figure 55: iHP24H3A-SQ-00 Output Voltage Startup Characteristic
 Load: R = 0.2 ohm
 Ch 2: I_o

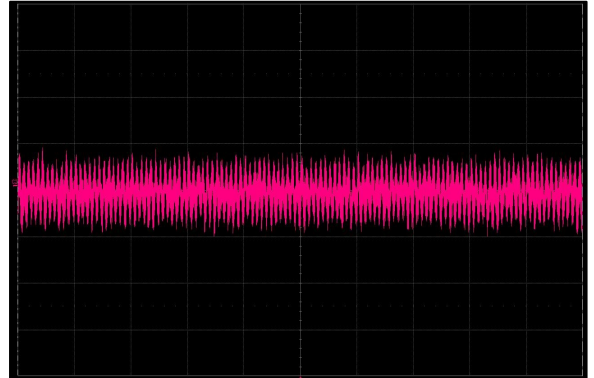

Measure 100 mA/div 10.000000
 100.000000 10.000000
 Measure 100 mA/div 10.000000
 100.000000 10.000000
 Timebase: 0.04 ms Trigger: \square 00
 50 100 ms/div Auto 2.1 kV 2.1 MS 500

Figure 56: iHP24H3A-SQ-00 Ripple and Noise Measurement
 Load: R = 0.2 ohm
 Ch 2: I_o

ELECTRICAL SPECIFICATIONS

12V 2400W Module (SL) Performance Curves - Constant Voltage Mode

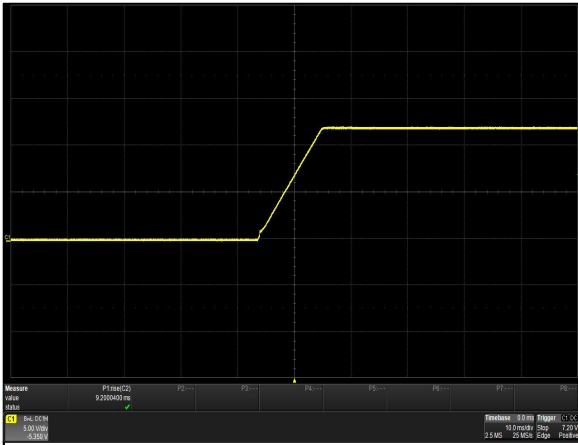

Figure 57: iHP24H3A-SL-00 Output Voltage Startup Characteristic
Load: $I_o = 200A$
Ch 1: V_o

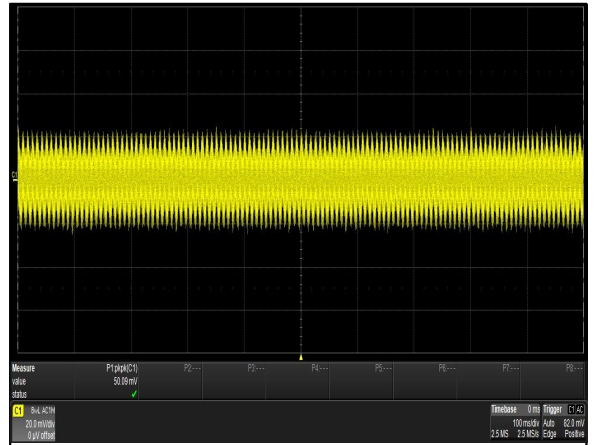

Figure 58: iHP24H3A-SL-00 Ripple and Noise Measurement
Load: $I_o = 200A$
Ch 1: V_o

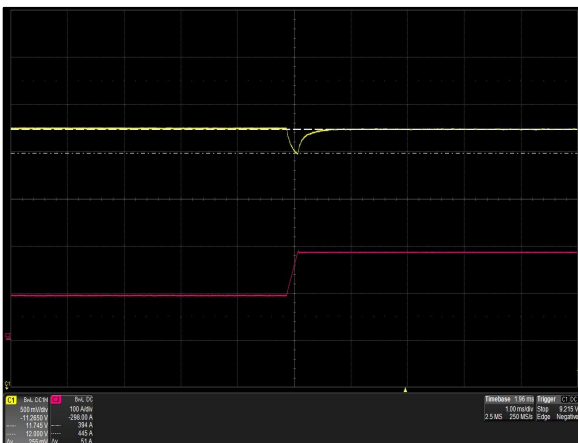

Figure 59: iHP24H3A-SL-00 Transient Response - V_o Deviation
50% to 100% load change, $0.5A/\mu S$ slew rate
Ch 1: V_o Ch 2: I_o

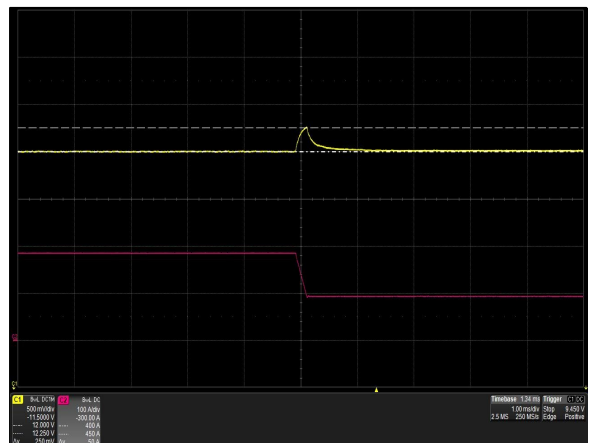

Figure 60: iHP24H3A-SL-00 Transient Response - V_o Deviation
100% to 50% load change, $0.5A/\mu S$ slew rate
Ch 1: V_o Ch 2: I_o

ELECTRICAL SPECIFICATIONS

12V 2400W Module (SL) Performance Curves - Constant Current Mode

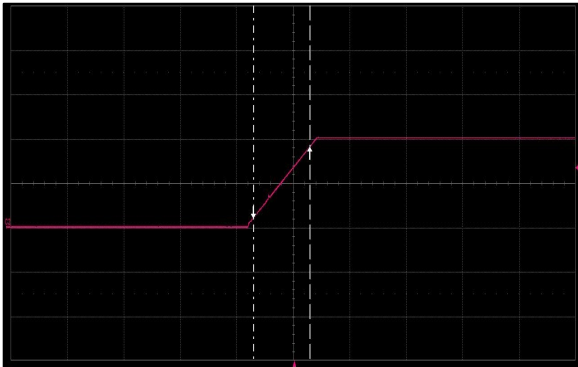

Figure 61: iHP24H3A-SL-00 Output Voltage Startup Characteristic
 Load: R = 0.06 ohm
 Ch 2: I_o

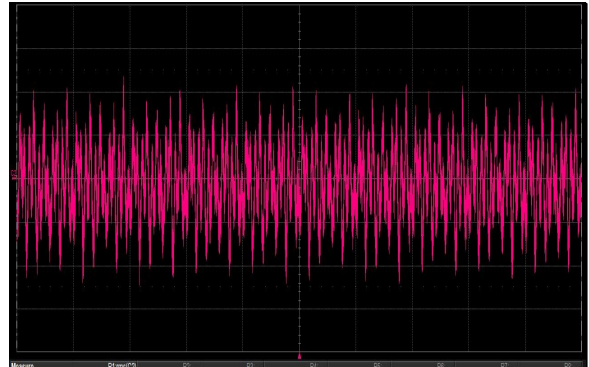

Figure 62: iHP24H3A-SL-00 Ripple and Noise Measurement
 Load: R = 0.06 ohm
 Ch 2: I_o

ELECTRICAL SPECIFICATIONS

50V 12000W Module (TW) Performance Curves - Constant Voltage Mode

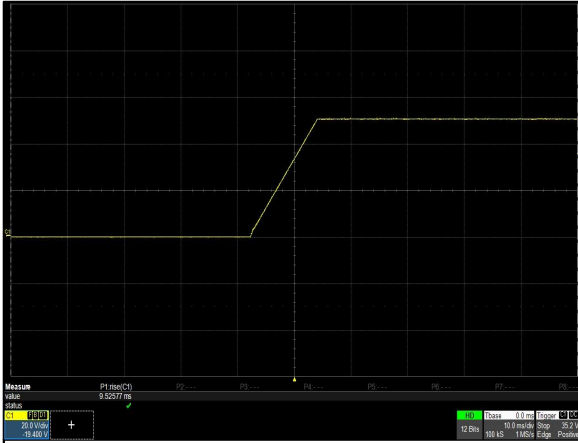

Figure 63: iHP12L1A-TW-00 Output Voltage Startup Characteristic
Load: $I_o = 240A$
Ch 1: V_o

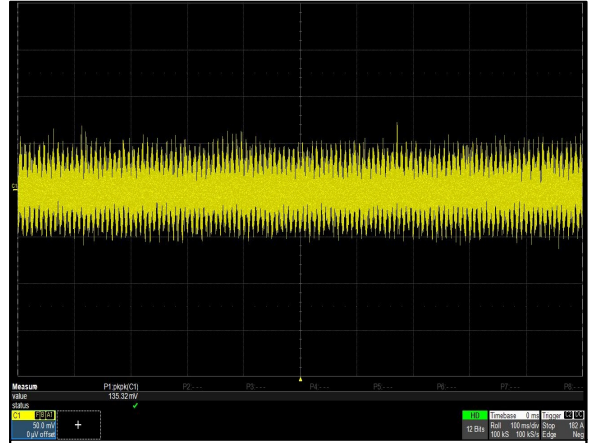

Figure 64: iHP12L1A-TW-00 Ripple and Noise Measurement
Load: $I_o = 240A$
Ch 1: V_o

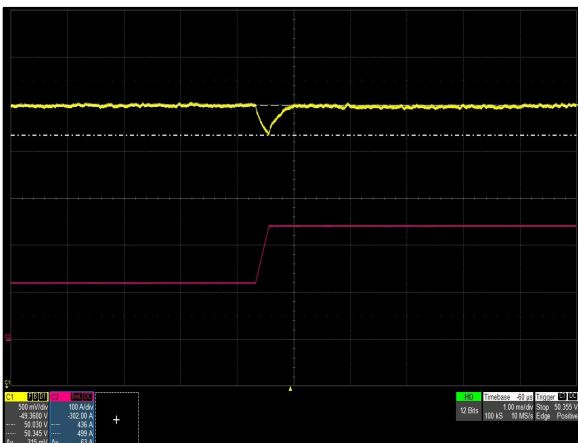

Figure 65: iHP12L1A-TW-00 Transient Response - V_o Deviation
50% to 100% load change, $0.5A/\mu S$ slew rate
Ch 1: V_o Ch 2: I_o

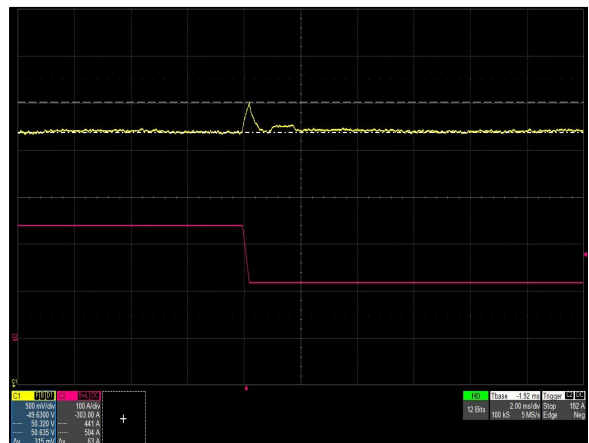

Figure 66: iHP12L1A-TW-00 Transient Response - V_o Deviation
100% to 50% load change, $0.5A/\mu S$ slew rate
Ch 1: V_o Ch 2: I_o

ELECTRICAL SPECIFICATIONS

50V 12000W Module (TW) Performance Curves - Constant Current Mode

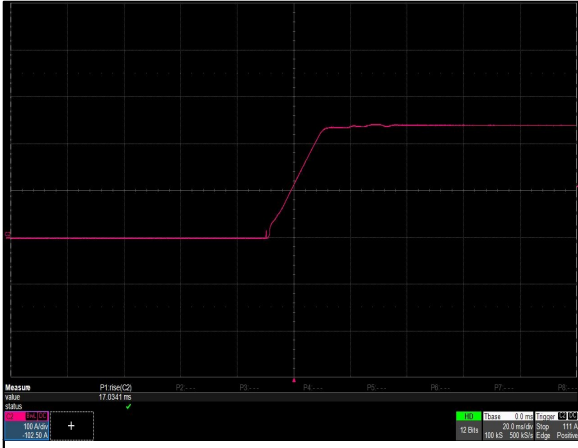

Figure 67: iHP12L1A-TW-00 Output Voltage Startup Characteristic
 Load: R = 0.208 ohm
 Ch 2: I_o

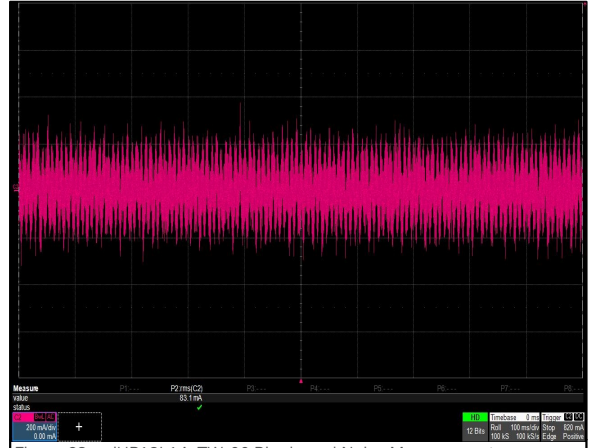

Figure 68: iHP12L1A-TW-00 Ripple and Noise Measurement
 Load: R = 0.208 ohm
 Ch 2: I_o

ELECTRICAL SPECIFICATIONS

Protection Function Specifications

Input Fuse

The iHP Series is equipped with internal non user serviceable 25A 600Vac fast acting fuse. The input fuse is distributed to each PFC.

Take iHP24 case as example. There are two EMI-PFC boards. Each EMI-PFC board can support 4 modules. Each EMI-PFC board has 6 PFC circuits. Each PFC circuit can support 2 kW load. Each PFC has 2 input AC fuses with 25A rating.

Input Over Voltage Protection

The iHP series power supply will withstand a continuous over input voltage up to 115% of nominal input voltage with no permanent damage.

Parameter	Min	Nom	Max	Unit
V_{IN} Input Overvoltage	/	/	115	% V_{IN}

Output Over Voltage Protection (OVP)

The iHP series power supply latches off during output overvoltage with the AC line recycled to reset the latch.

Parameter	Min	Nom	Max	Unit
Tracking OVP - First level OVP	120	/	130	% $V_{O,set\ point}$
Brick Wall OVP - Second level OVP	110	/	130	% $V_{O,max}$

Over Current Protection (OCP)

The iHP series output module includes internal current limit circuitry to prevent damage in the event of overload or short circuit.

There're two types of OCP mode. One is constant current, the other one is latch. The over current response type can be changed by the module command 52h. Refer to the iHP software technical reference note for details.

DVS mode OCP default is CC type; DCS mode OCP default is latch type.

ELECTRICAL SPECIFICATIONS

Parameter	Description	Min	Nom	Max	Unit
Vo Output Over Current - Constant Current Mode ¹	CC level setting should be up to 104% of maximum output current only	100	/	104	%I _{O,max}
	Second level protection (latch mode)	105	/	120	%I _{O,max}
	Third level protection (fast latch mode)	120	/	130	%I _{O,max}
Vo Output Over Current - Latch Mode ²	Unit will shut down upon fault triggering	110	/	120	%I _{O,max}
	Second level protection (fast latch mode)	120	/	130	%I _{O,max}

Note 1 - Output current will be clamped to a specified maximum level.

Note 2 - Applicable only on a single module operation. Otherwise, use constant current mode.

Short Circuit Protection (SCP)

The iHP series power supply will withstand a continuous short circuit with no permanent damage, applied to its main output during start-up or while running. Output will latch off.

DVS mode OCP default is CC type

DCS mode OCP default is latch type.

Over Temperature Protection (OTP)

The iHP series power supply is internally protected against over temperature conditions. When over temperature circuit is activated, the power supply output will disable. Recovery type will be auto-recovery with temperature hysteresis.

MECHANICAL SPECIFICATIONS

iHP Case Mechanical Outlines (unit: mm)

Front Panel Standard Markings
(Standard for both 12 kW and 24 kW)

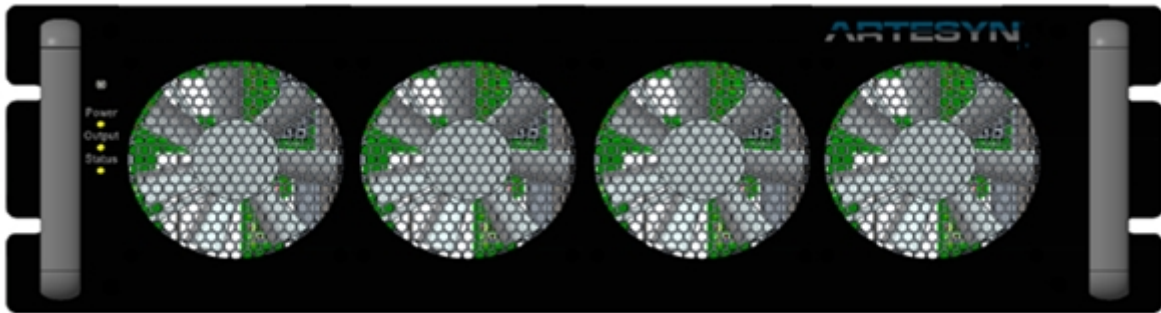

Input and Comms Standard Markings
(View of iHP24L/H and iHP12L/H shown on top, iHP24C shown on bottom.
Comms interface is horizontal on the iHP12L/H.)

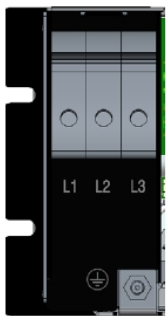

iHP12 and iHP24 L/H/S Input



iHP24C Input

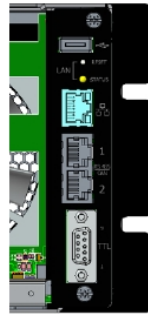

Default Comms interface



Optional Comms interface

MECHANICAL SPECIFICATIONS

iHP24 Series Mechanical Outlines (unit: mm)

iHP24 (24 kW Max)

Case Size: iHP24: 29.62" x 19.00" x 5.22" (752.28 mm x 482.6 mm x 132.5 mm)

Weight: Rack standalone, 36.0kg

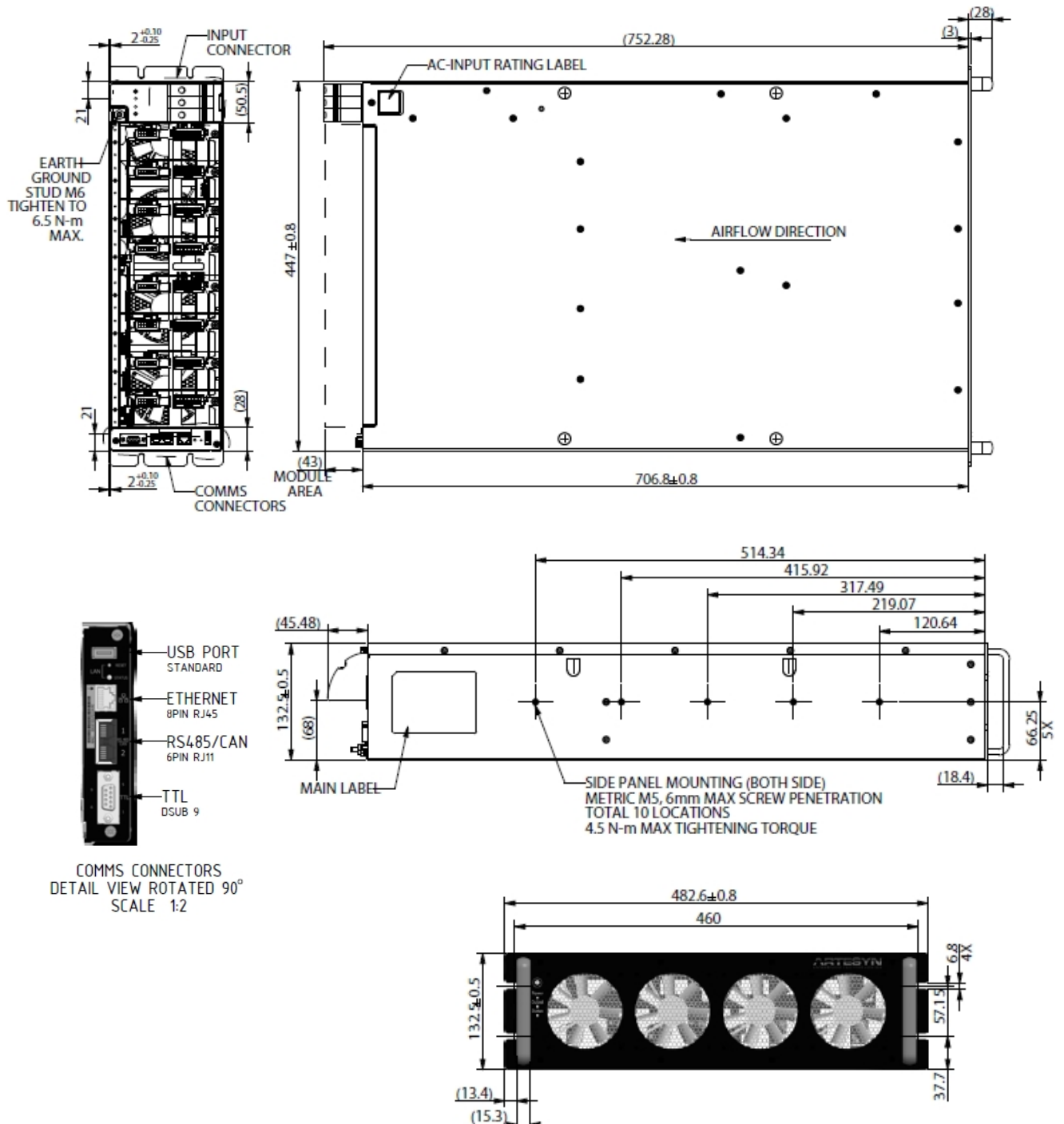

MECHANICAL SPECIFICATIONS

iHP24C Series Mechanical Outlines (unit: mm)

iHP24C (24 kW Max)

Case Size: iHP24C:29.09" x 19.00" x 5.22" (738.2 mm x 482.6 mm x 132.5 mm)

Weight: Rack standalone, 35.0kg

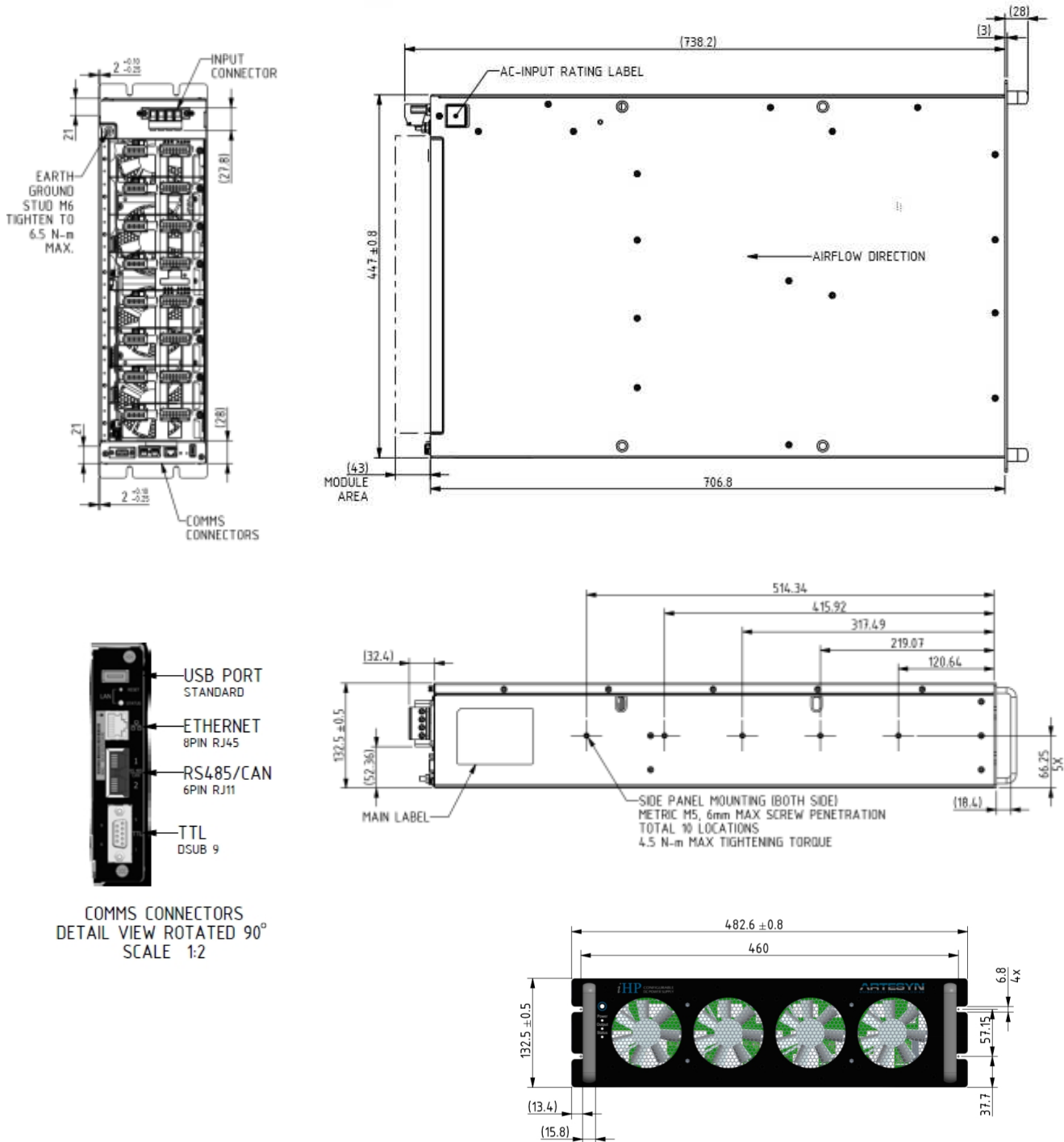

MECHANICAL SPECIFICATIONS

iHP24S Series Mechanical Outlines (unit: mm)

iHP24S (24 kW Max)

Case Size: iHP24S: 25.43" x 19.00" x 5.22" (645.48 mm x 482.6 mm x 132.5 mm)

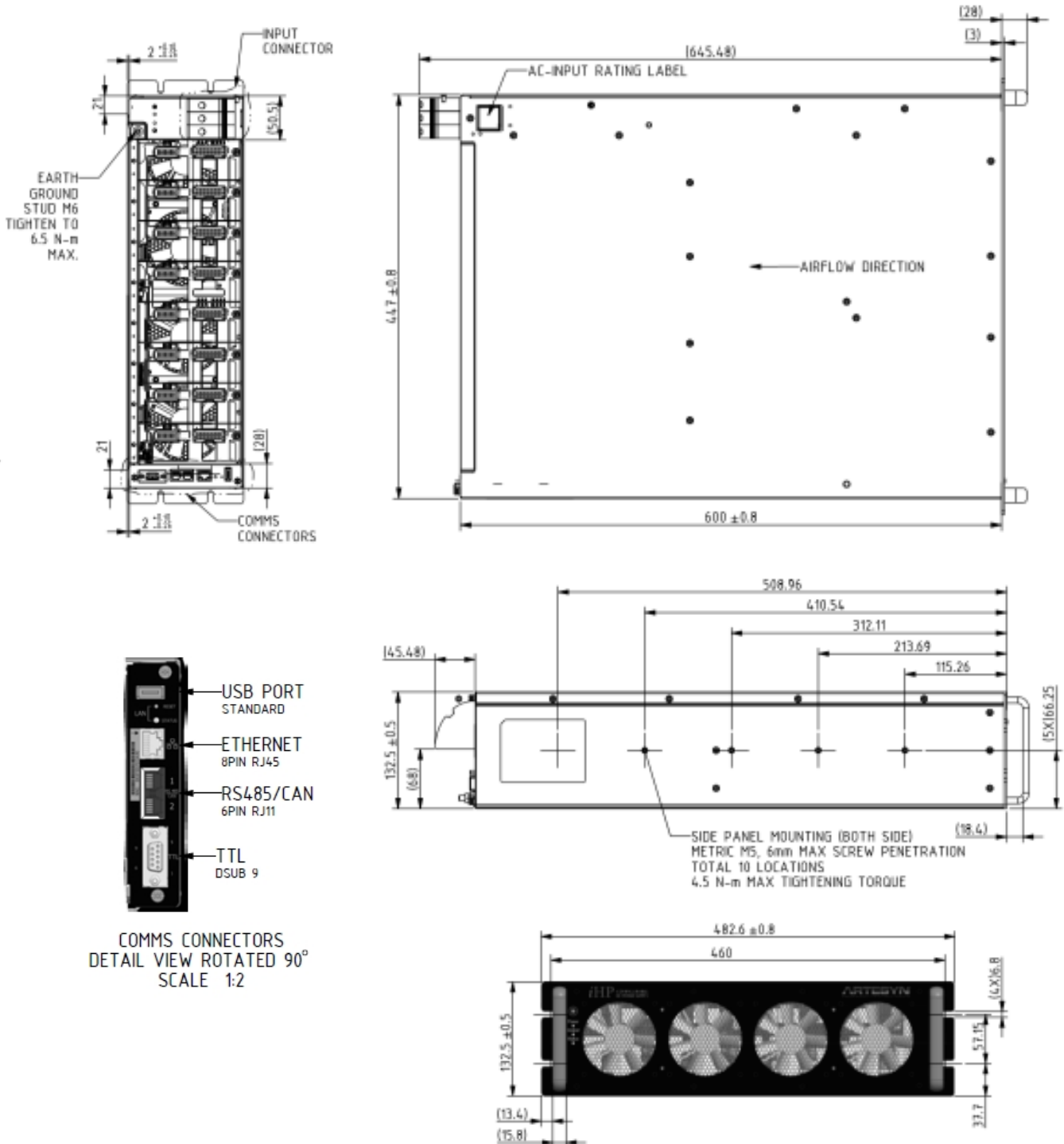

MECHANICAL SPECIFICATIONS

iHP12 Series Mechanical Outlines (unit: mm)

iHP12 (12 kW Max)

Case Size: iHP12:19.79" x 19.00" x 5.22" (502.68 mm x 482.6 mm x 132.5 mm)

Weight: Rack standalone, 22.2 kg

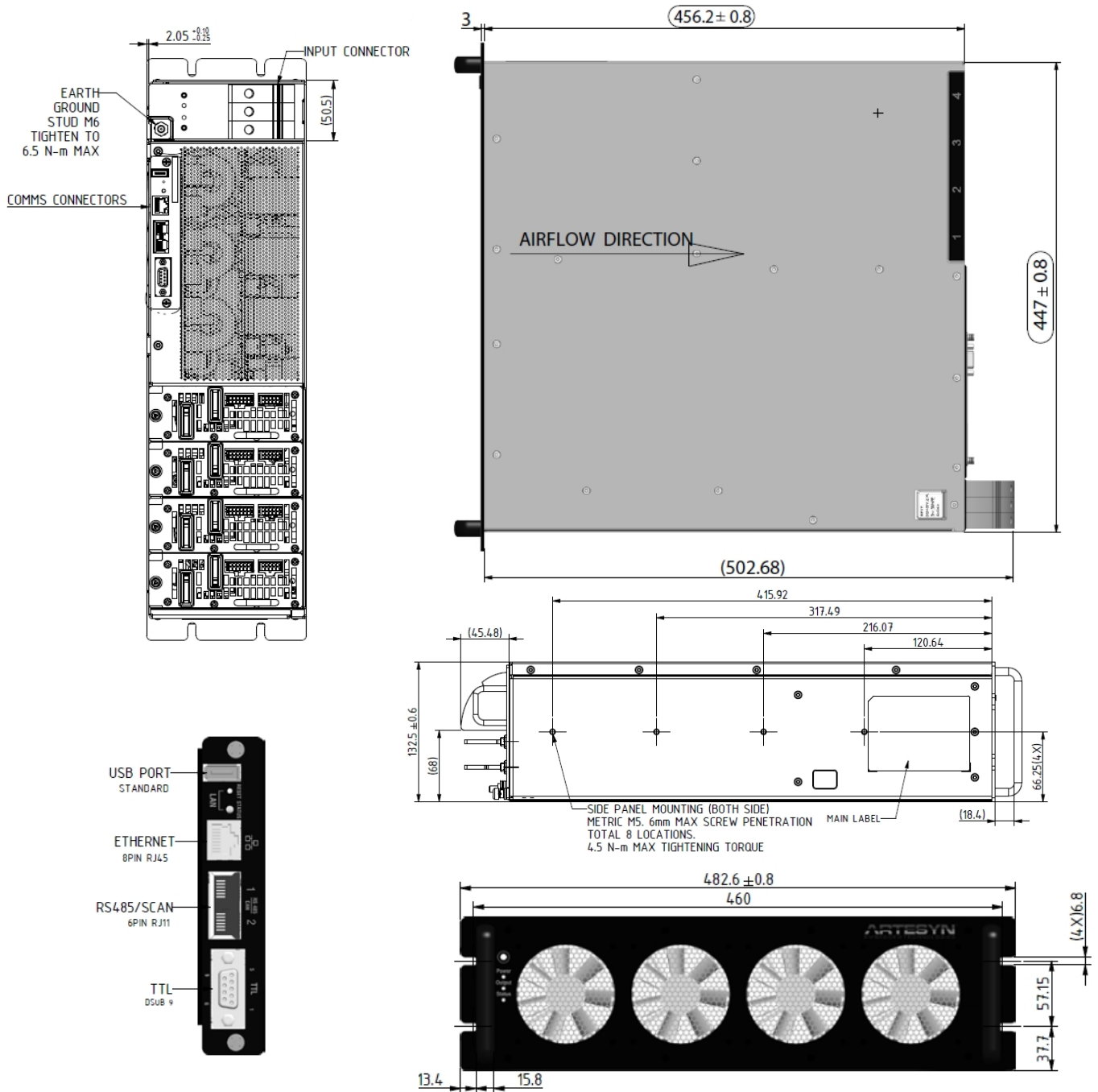

MECHANICAL SPECIFICATIONS

iHP Module Mechanical Outlines - 3000W (unit: mm)

Weight: 3000W Single O/P module, 2.2Kg for 12V module; 2.0Kg for other modules

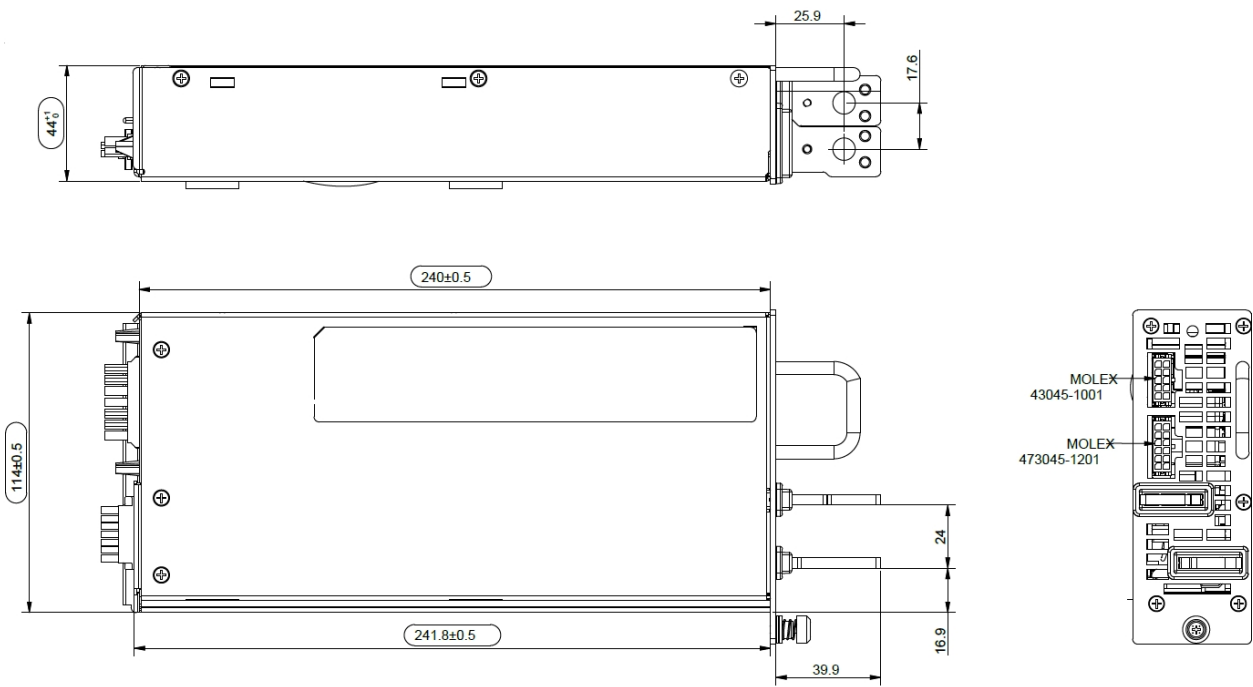
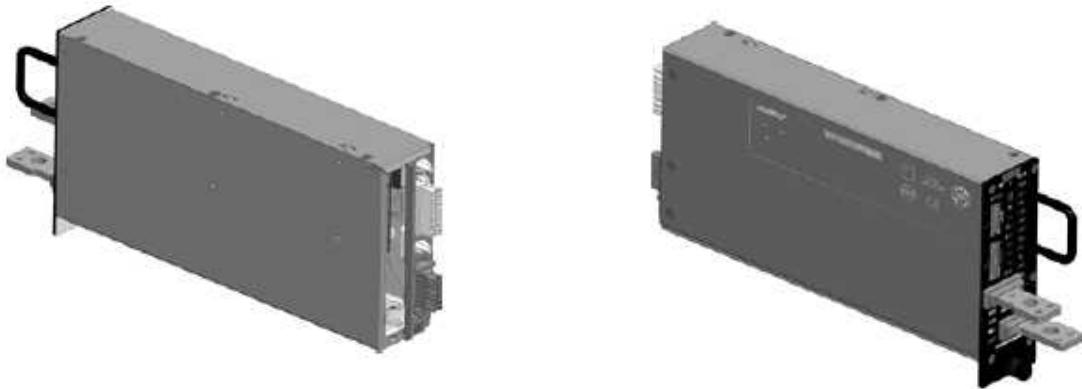

MECHANICAL SPECIFICATIONS

iHP Module Mechanical Outlines - 12000W (unit: mm)

Weight: 12000W Single O/P module, 5.95Kg for 12 kW modules

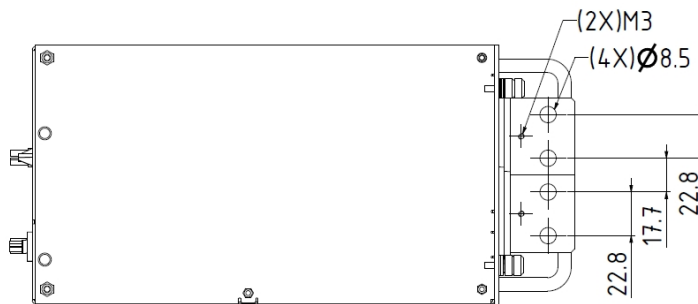
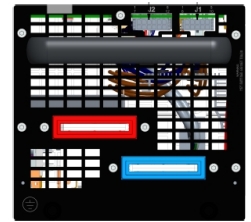
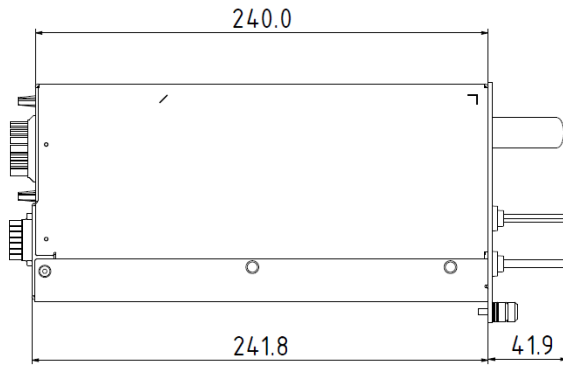
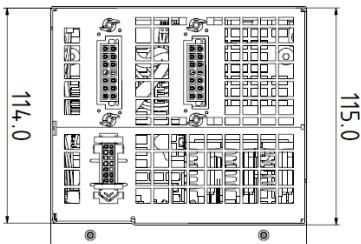
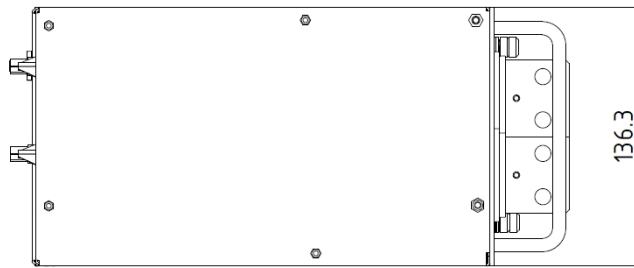
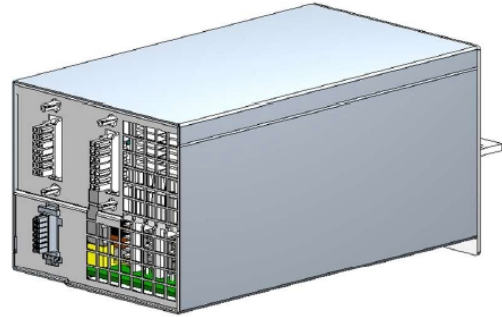

MECHANICAL SPECIFICATIONS

Connector Definitions - Case

AC Input Connector

- L1 - Line 1
- L2 - Line 2
- L3 - Line 3
- N - Neutral
- Screw - Protective earth ground

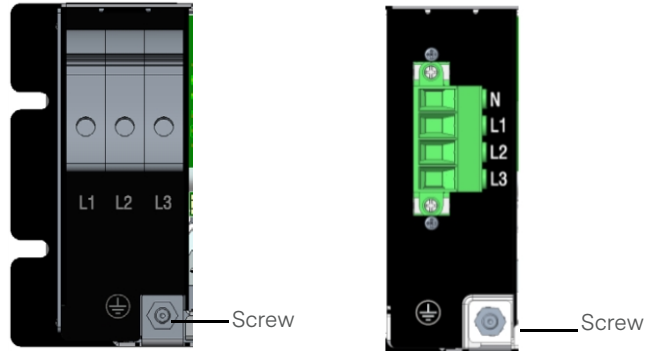

Communication Port

Default communication port provides Ethernet UDP. An optional ISOCOMM board is provided EtherCAT interface. Refer to the iHP software technical reference note for details.

1. Default ISOCOMM Board:

- | | |
|-------------------------------|-----------------------------------------|
| RS485/CAN - RJ11 | TTL- DSUB9 |
| Pin 1 - CANL | Pin 1 - 5V Housekeeping Bias |
| Pin 2 - CANH | Pin 2 - 5V Housekeeping Bias Return |
| Pin 3 - GND | Pin 3 - Spare (Not Connected) |
| Pin 4 - 5V Housekeeping bias | Pin 4 - Global Inhibit/Enable Logic "1" |
| Pin 5 - RS485_A | Pin 5 - Global Inhibit/Enable Logic "0" |
| Pin 6 - RS485_B | Pin 6 - ACOK- "Emitter". |
| Pin 7 - CANL | Pin 7 - ACOK+ "Collector" |
| Pin 8 - CANH | Pin 8 - Global DC OK- "Emitter" |
| Pin 9 - GND | Pin 9 - Global DC OK+ "Collector" |
| Pin 10 - 5V Housekeeping bias | |
| Pin 11 - RS485_A | |
| Pin 12 - RS485_B | |

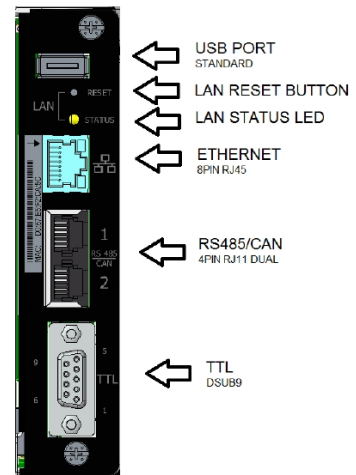

2. Optional ISOCOMM Board:

- | | |
|----------------------------|-------------------|
| CAN - J1520/J1522 | TTL- DSUB9 |
| Pin 1 - CANL | Pin 1 - +24V_IN |
| Pin 2 - CANH | Pin 2 - RTN |
| Pin 3 - NC (Not Connected) | Pin 3 - INTLK+ |
| Pin 4 - DGND | Pin 4 - INTLK- |
| | Pin 5 - +24V_Bias |
| | Pin 6 - INTLK_OK |
| | Pin 7 - AC_OK |
| | Pin 8 - DC OK |
| | Pin 9 - 5V_STBY |

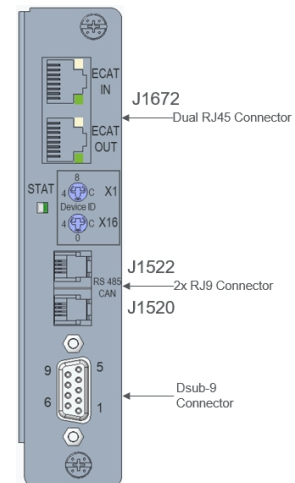

MECHANICAL SPECIFICATIONS

Connector Definitions - Module (3000W)

Main Output Terminals

Red terminal - Positive Output

Blue terminal - Negative Output

DC Output Control Signal Connector - J1

Pin 1 - 0-10VEXT_VPROG

Pin 2 - 0-5VEXT_VPROG

Pin 3 - 0-10VEXT_IPROG

Pin 4 - 0-5VEXT_IPROG

Pin 5 - 4-20mA_IPROG

Pin 6 - 4-20mA_VPROG

Pin 7 - SYS_M_INHIBIT

Pin 8 - SYS_RTN

Pin 9 - SYS_M_ENABLE#

Pin 10 - SYS_M_FAULT#

DC Output Control Signal Connector- J2

Pin 1 - V_SNS+

Pin 2 - D_RTN

Pin 3 - EXT_ISENSE+

Pin 4 - D_RTN

Pin 5 - IMON

Pin 6 - Not Connected

Pin 7 - D_RTN

Pin 8 - V_SNS-

Pin 9 - EXT_ISENSE-

Pin 10 - ISHARE

Pin 11 - VMON

Pin 12 - ISHARE

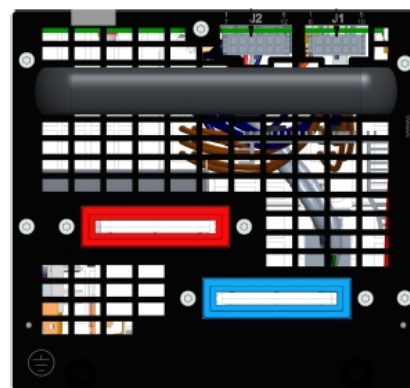
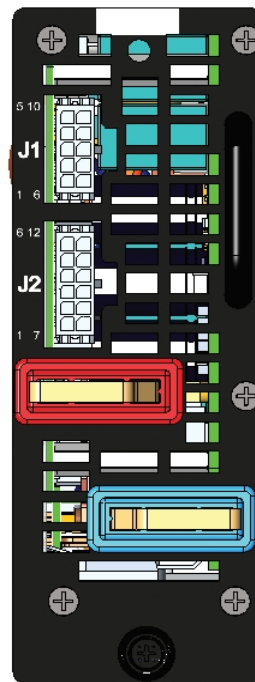

MECHANICAL SPECIFICATIONS

Power / Signal Mating Connectors and Pin Types

Table 34. Mating Connectors for iHP (or equivalent)	
Reference	Mating Connector or Equivalent
AC Input (Terminal block)	MFR: Phoenix Contact MPN: UWV 25 Conductor Range 10 - 2 AWG Tightening Torque 4.5N-m MAX
Earth Ground	Stud M6 Tighten to 6.5N-m MAX
Module Signal Connector - J1	Molex 43025-1000 (housing) Crimp Terminal AWG 20-24 Crimp Terminal Molex MPN: 43030-0002
Module Signal Connector - J2	Molex 43025-1200 (housing) Crimp Terminal AWG 20-24 Crimp Terminal Molex MPN: 43030-0002

MECHANICAL SPECIFICATIONS

LED Indicator Definitions

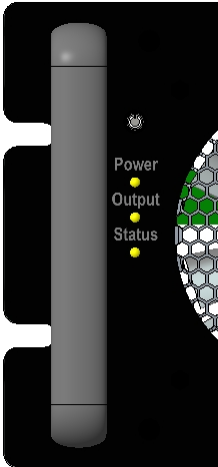

Three bi-color (green/red/amber) LED at the power supply front provides status signal. The status LED conditions is shown on the below table.

Conditions	Power LED	Output LED	Status LED
No AC	OFF	OFF	OFF
ISOCOMM Start-Up Boot Load	Blinking Green	OFF	OFF
Sleep Mode (ON/OFF switch)	Amber	OFF	OFF
Global Inhibit	Solid Green	Blinking Green	OFF
AC Good	Solid Green	-	-
AC Fault (OV,UV)	Solid Red	OFF	Solid Red
Output Good	Solid Green	Solid Green	Solid Green
Auto-recoverable Fault(OTP)	Solid Green	OFF	Solid Amber
Latching Fault (OVP,UVP) or Internal Fault	Solid Green	OFF	Solid Red
Fan Fail	Solid Green	OFF	Blinking Red
Boot loading	-	OFF	Blinking Amber

ENVIRONMENTAL SPECIFICATIONS

EMC Immunity

iHP series power supply is designed to meet the following EMC immunity specifications.

Table 35. Environmental Specifications - except iHP24C3A			
Document	Description		
EN55011, FCC CFR 47, Part 15, Subpart B, Class A	Conducted and Radiated EMI Limits		
IEC/EN 61000-4-2	Electromagnetic Compatibility (EMC) - Testing and measurement techniques – Electrostatic discharge immunity test. +/-15KV air, +/-8KV contact discharge, performance Criteria A		
IEC/EN 61000-4-3	Electromagnetic Compatibility (EMC) - Testing and measurement techniques, Radiated, radio-frequency, electromagnetic field immunity test		
IEC/EN 61000-4-4	Electromagnetic Compatibility (EMC) - Testing and measurement techniques, Electrical Fast Transient/Burst Immunity Test. 4KV for AC power port, Criteria A		
IEC/EN 61000-4-5	Electromagnetic Compatibility (EMC) - Testing and measurement techniques – 4 kV common mode and 2 kV differential mode for AC ports, I/O and signal ports, performance criteria A		
IEC/EN 61000-4-6	Conducted Immunity 150KHz - 80KHz, 10V _{RMS} , performance criteria A		
EN61000-4-8	Power Frequency Magnetic Field		
EN61000-4-34 SEMI F47	Voltage Dips and Sags		
	>95% Reduction for	10mS	Criteria A
	>30% Reduction for	500mS	Criteria A
	>95% Reduction for	500mS	Criteria C
	20% Reduction for	5000mS	Criteria A
	30% Reduction for	500mS	Criteria A
	50% Reduction for	200mS	Criteria A
	60% Reduction for	200mS	Criteria B

ENVIRONMENTAL SPECIFICATIONS

EMC Immunity

iHP series power supply is designed to meet the following EMC immunity specifications.

Table 36. Environmental Specifications - iHP24C3A																									
Document	Description																								
EN55011, FCC CFR 47, Part 15, Subpart B, Class A	Conducted and Radiated EMI Limits																								
IEC/EN 61000-4-2	Electromagnetic Compatibility (EMC) - Testing and measurement techniques – Electrostatic discharge immunity test. +/-15KV air, +/-8KV contact discharge, performance Criteria A																								
IEC/EN 61000-4-3	Electromagnetic Compatibility (EMC) - Testing and measurement techniques, Radiated, radio-frequency, electromagnetic field immunity test																								
IEC/EN 61000-4-4	Electromagnetic Compatibility (EMC) - Testing and measurement techniques, Electrical Fast Transient/Burst Immunity Test. 4KV for AC power port, Criteria A																								
IEC/EN 61000-4-5	Electromagnetic Compatibility (EMC) - Testing and measurement techniques - 4KV common mode and 2KV differential mode for AC ports, I/O and signal ports, performance criteria A																								
IEC/EN 61000-4-6	Conducted Immunity 150KHz - 80KHz, 10V _{RMS} , performance criteria A																								
EN61000-4-8	Power Frequency Magnetic Field																								
EN61000-4-11	<table border="0"> <tr> <td>Voltage Dips and Sags</td> <td></td> <td></td> </tr> <tr> <td>>95% Reduction for</td> <td>10mS</td> <td>Criteria A</td> </tr> <tr> <td>>30% Reduction for</td> <td>500mS</td> <td>Criteria A</td> </tr> <tr> <td>>95% Reduction for</td> <td>500mS</td> <td>Criteria C</td> </tr> <tr> <td>20% Reduction for</td> <td>5000mS</td> <td>Criteria A</td> </tr> <tr> <td>30% Reduction for</td> <td>500mS</td> <td>Criteria A</td> </tr> <tr> <td>50% Reduction for</td> <td>200mS</td> <td>Criteria A</td> </tr> <tr> <td>60% Reduction for</td> <td>200mS</td> <td>Criteria B</td> </tr> </table>	Voltage Dips and Sags			>95% Reduction for	10mS	Criteria A	>30% Reduction for	500mS	Criteria A	>95% Reduction for	500mS	Criteria C	20% Reduction for	5000mS	Criteria A	30% Reduction for	500mS	Criteria A	50% Reduction for	200mS	Criteria A	60% Reduction for	200mS	Criteria B
Voltage Dips and Sags																									
>95% Reduction for	10mS	Criteria A																							
>30% Reduction for	500mS	Criteria A																							
>95% Reduction for	500mS	Criteria C																							
20% Reduction for	5000mS	Criteria A																							
30% Reduction for	500mS	Criteria A																							
50% Reduction for	200mS	Criteria A																							
60% Reduction for	200mS	Criteria B																							

ENVIRONMENTAL SPECIFICATIONS

Safety Certifications

The iHP series power supply is intended for inclusion in other equipment and the installer must ensure that it is in compliance with all the requirements of the end application. This product is only for inclusion by professional installers within other equipment and must not be operated as a stand alone product.

Table 37. Safety Certifications for iHP Series Power Supply System - except iHP24C3A		
Standard	File #	Description
UL 60950-1 2 nd Edition	E186249-A314-UL-X6	US ITE Requirements
UL 62368-1 2 nd Edition	E186249-A6018-UL-X11	Canadian ITE Requirements
IEC60950-1/EN60950-1	E186249-A314-CB-1	International ITE Requirements
EN60601-1	Z2 17 08 13890 02874	European Medical Requirements
IEC60601-1	SG PSB-MD-00096M1	International Medical Requirements
UL 60601-1 1 st Edition; ANSI/AAMI ES60601-1	E182560-V4-S73	US Medical Requirement
TUV-SUD Report	211-2716005-200	
CB Certificate and Report	DK-53706-A2-UL	(All CENELEC Countries)
CE (LVD+RoHS)	19111	European Requirements
UKCA		UK Requirements

Table 38. Safety Certifications for iHP Series Power Supply System - iHP24C3A		
Standard	File #	Description
CE (LVD+RoHS)	19100	European Requirements
CB Certificate and Report	DK-85275-UL	(All CENELEC Countries)
UL/cUL	E186249-A6021-UL-X11	Canadian ITE Requirements
TUV-SUD	B 013890 3019 Rev. 00	
UL Report	E186249-A6021-CB-1	International ITE Requirements
UKCA		UK Requirements

ENVIRONMENTAL SPECIFICATIONS

EMI Emissions

The iHP series has been designed to comply with the Class A limits of EMI requirements of EN55011 (FCC CFR47, Part 15, Subpart B) and CISPR 11 (EN55011) for emissions and relevant sections of EN61000 (IEC 61000) for immunity. The unit is tested at 24 kW load.

Conducted Emissions

The applicable standard for conducted emissions is EN55022 (FCC Part 15). Conducted noise can appear as both differential mode and common mode noise currents. Differential mode noise is measured between the two input lines, with the major components occurring at the supply fundamental switching frequency and its harmonics. Common mode noise, a contributor to both radiated emissions and input conducted emissions, is measured between the input lines and system ground and can be broadband in nature.

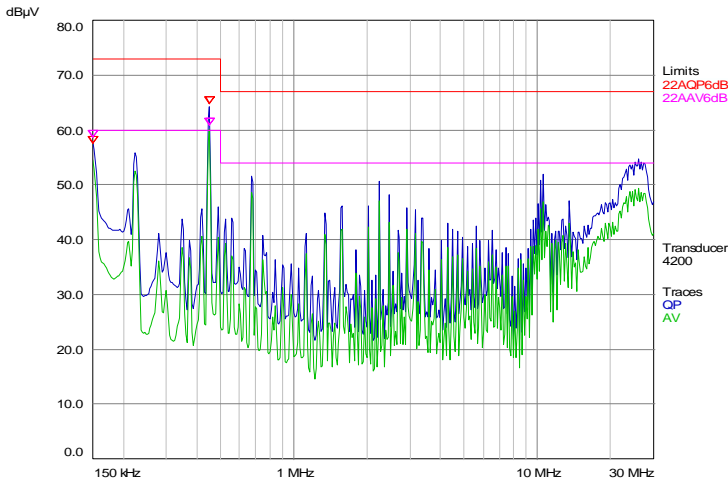

The iHP series power supplies have internal EMI filters to ensure the converters' conducted EMI levels comply with EN55011 (FCC CFR47, Part 15, Subpart B) Class A and EN55011 (CISPR 11) class A limits. The EMI measurements are performed with resistive loads at maximum rated loading.

Sample of EN55022 Conducted EMI Measurement at 400Vac three phase input.

Note: Red Line refers to Artesyn Quasi Peak margin, which is 5dB below the CISPR international limit. Pink Line refers to the Artesyn Average margin, which is 5dB below the CISPR international limit.

Conducted EMI emissions specifications of the iHP series:

Parameter	Model	Symbol	Min	Typ	Max	Unit
FCC Part 15, class B	All	Margin	5	-	-	dB
CISPR 32 (EN55022), class B	All	Margin	5	-	-	dB

ENVIRONMENTAL SPECIFICATIONS

Operating Temperature

The iHP series power supplies can start and operate within the stated specifications at an ambient temperature from 0°C to 50°C under all load conditions with internal fan.

Forced Air Cooling

The iHP series power supplies include internal cooling fans as part of the power supply assembly to provide forced air-cooling to maintain and control temperature of devices and ambient temperature in the power supply to appropriate levels.

Fan noise <65 dBA with 80% load @ 30°C at nominal input voltage with smart Fan algorithm be optimized based on module and case thermal sensors. When modules are inhibited via software control, the fan speed is reduced to minimum speed and acoustic noise is < 46 dBA. With modules off via front panel switch fans cycle between minimum speed for 1 minute and off for 9 minutes.

Fan noise < 80 dBA continuous for 24 hrs.

DLC Life Projection Data

In accordance with DLC technical requirements for LED-based Horticultural Lighting V2.1 “Special Considerations for DC-Powered Fixtures”, operating assumptions and certified test data are provided below:

Model:	iHP24H3A-S2(8)-00/iHP24SH3A-S2(8)-00
Description:	380/480Vac nominal input 3-Phase with eight (8) isolated 3000W modules with a nominal output voltage of 250Vdc
Measured Efficiency:	94.32% minimum @ 480Vac 3-phase input with 100% loading on the outputs. T _{amb} =25°C
Operating Temp Range:	0 to 45°C. for Horticultural Lighting Applications
Power Factor:	0.9884
Total Harmonic Distortion:	0.80% @ 100% load
Warranty:	5 years

Driver ISTMT thermal measurement points and Product Lifetime:

Temperature probe for inlet located on each of the for fans, 1” away from the grill
 Temperature probe for outlet located next to top of the output module handle in the airflow

Note that the average temperature rise in the power system 19°C at full load. Slight variations at different inlet temperatures are caused by the variable fan speed algorithm. All life calculations are based on the inlet temperature and worst case input voltage, and output loading.

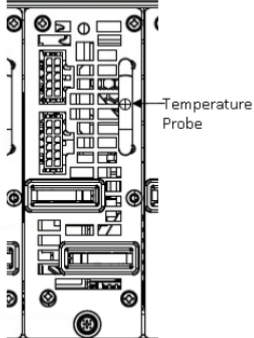
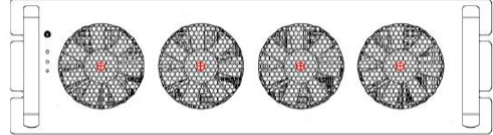
Max. Measured Temperature (°C) @ Air Inlet Ambient	Measured at Output Module Handle (+/-2°C)		
	480VAC	380VAC	
50°C	66.9	68.6	
45°C	61.7	64.7	
40°C	57.1	59.5	
35°C	50.5	53.6	
30°C	45.6	48.6	
	Note: Data is average temperature measured for all 8 modules		
Operating Altitude	Sea Level		

ENVIRONMENTAL SPECIFICATIONS

Input Voltage @ 480 (Vac)

Inlet Temperature (°C)	Module Handle Temperature (°C)	System Projected Life (Years)
50	68	4.86
45	63	6.13
40	58	7.70
35	53	9.61
30	48	11.88
25	43	14.54

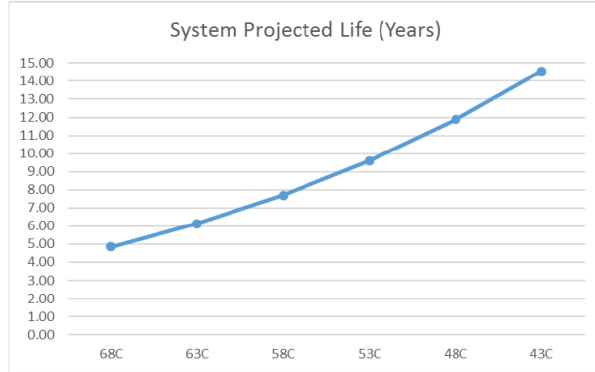

Input Voltage @ 380 (Vac)

Inlet Temperature (°C)	Module Handle Temperature (°C)	System Projected Life (Years)
50	68	4.99
45	63	6.30
40	58	7.89
35	53	9.81
30	48	12.09
25	43	14.74

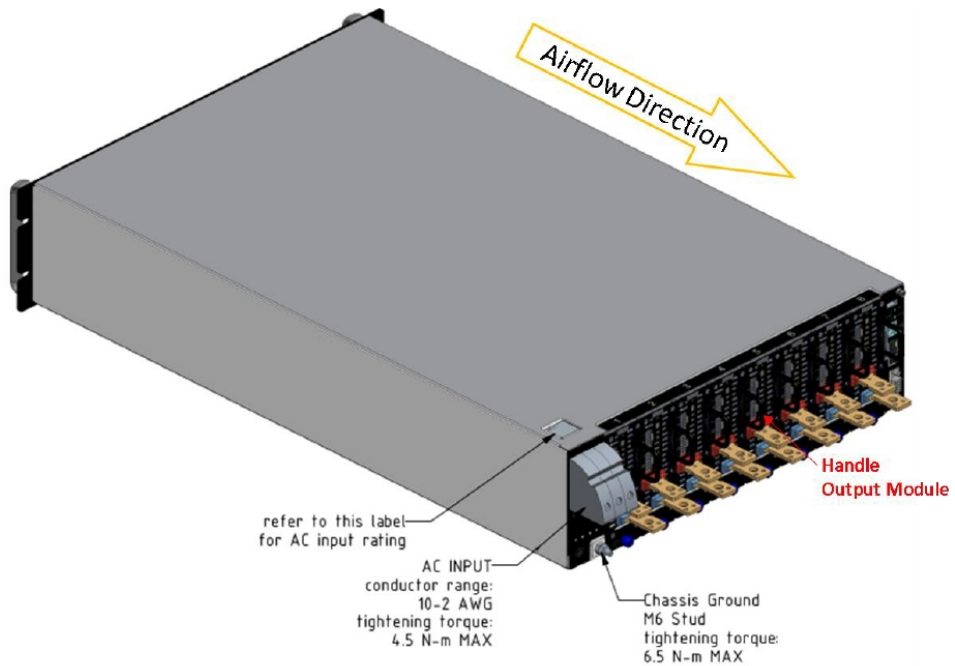
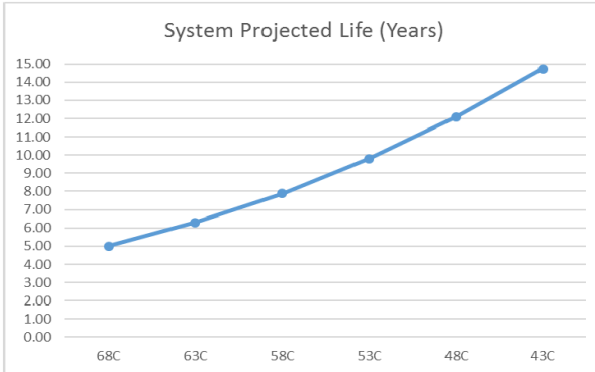

Note: Front & Rear of Power Supply should maintain minimum 150mm clearance to nearest wall or obstruction.

ENVIRONMENTAL SPECIFICATIONS

Storage and Shipping Temperature

The iHP series power supplies can be stored or shipped at temperatures between -40°C to $+85^{\circ}\text{C}$, and relative humidity from 10% to 95% non-condensing.

Altitude

The iHP series can operate within specifications at altitudes up to 9842 feet (3000 meters) above sea level. The power supply shall not be damaged when stored at altitudes of up to 30,000 feet (9144 meters) above sea level.

Humidity

The iHP series can be operated within specifications when subjected to a relative humidity from 20% to 90% non-condensing. The iHP series can be stored in a relative humidity from 10% to 95% non-condensing.

Vibration

The iHP series power supply will pass the following vibration specifications:

Operating Sinusoidal Vibration 1 (iHP12 / iHP24 Rack and module configuration)

Reference Document	MIL-STD-810G Method 528 Procedure I (Type 1)	
Amplitude	0.01	inch
Frequency Range	4 - 33	Hz
Sweep Rate	0.067	Hz/sec
Direction	3 mutually perpendicular axis	
PSD Profile	FREQ (Hz)	Amplitude (inch)
	4 - 15	0.030 ± 0.006
	16 - 25	0.020 ± 0.004
	26 - 33	0.010 ± 0.002

Operating Sinusoidal Vibration 2 (iHP12 / iHP24 Rack and module configuration)

Reference Document	NEBS Office Vibration Environment, Alternate Procedure	
Acceleration	1	G
Frequency Range	5 - 100	Hz
Sweep Rate	0.25	Hz/sec
Direction	3 mutually perpendicular axis	

ENVIRONMENTAL SPECIFICATIONS

Non-Operating Random Vibration(iHP12 / iHP24 Rack only)

Acceleration	1.87	gRMS	
Frequency Range	10 - 500	Hz	
Duration	30	Mins	
Direction	3 mutually perpendicular axis		
PSD Profile	FREQ (Hz)	SLOPE (db/oct)	PSD (g ² /Hz)
	10	/	0.009
	200	-2.66	0.009
	500	/	0.004

Operating Random Vibration(iHP12 / iHP24 Rack and module configuration)

Reference Document	IPC-9592B Class 1		
Acceleration	0.71	gRMS	
Frequency Range	10 - 500	Hz	
Duration	30	Mins	
Direction	3 mutually perpendicular axis		
PSD Profile	FREQ (Hz)	SLOPE (db/oct)	PSD (g ² /Hz)
	10	5.938	0.000229
	30	/	0.0021
	200	-11.87	0.0021
	500	/	0.000054

Shock

The iHP series power supply will pass the following vibration specifications:

Non-Operating Half-Sine Shock(iHP12/iHP24 Rack only)

Acceleration	30	G
Duration	11	mSec
Pulse	Half-Sine	
Number of Shock	3 shocks in each of 6 faces	

ENVIRONMENTAL SPECIFICATIONS

Operating Half-Sine Shock(iHP12/iHP24 Rack only)

Acceleration	4	G
Duration	22	mSec
Pulse	Half-Sine	
Number of Shock	3 shocks in each of 6 faces	

Acceleration	15	G
Duration	11	mSec
Pulse	Half-Sine	
Number of Shock	3 shocks in each of 6 faces	

Harmonic Measurement

iHP12 Rack

Input Voltage: 380VAC

Load	iTHD	PWHD
25%	9.37%	4.68%
50%	5.62%	1.80%
75%	3.31%	2.88%
100%	3.01%	2.84%

iHP24 Rack

Input Voltage: 380VAC

Load	iTHD	PWHD
25%	6.81%	1.03%
50%	3.54%	0.73%
75%	1.81%	0.69%
100%	0.93%	0.64%

POWER AND CONTROL SIGNAL DESCRIPTIONS

AC Input Connector

This connector supplies the AC Mains to the iHP series power supply.

- L1 - Line 1
- L2 - Line 2
- L3 - Line 3
- N - Neutral
- Screw - Chassis Ground

Rack Communication Connector - USB Port

For Future Expansion.

Rack Communication Connector - LAN Port

LAN Port for Ethernet communication (Optional EtherCAT). Refer to the iHP software technical reference note for the details.

Rack Communication Connector - RS485/CAN Port on Default ISOCOMM Board

There are two identical port for RS485/CAN. The pin out of RS485/CAN port1 and RS485/CAN port2 are the same. All signals with the same signal name of RS485/CAN port1 and RS485/CAN port2 are internally connected.

The two ports functions to provide user easy iHP Rack to iHP Rack daisy chaining of the RS485 and CAN communication lines.

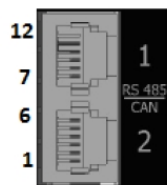

6pin RJ11 Dual

CANL	Pin 1, Pin 7
CANH	Pin 2, Pin 8
GND	Pin 3, Pin 9
5V Housekeeping Bias	Pin 4, Pin 10
RS485_A	Pin 5, Pin 11
RS485_B	Pin 6, Pin 12

CANL and CANH

The CAN communication lines are for communicating via the CAN protocol.

RS485_A and RS485_B

The RS485 communication lines are used for communicating using the RS485 protocol.

GND

The GND is used as the common ground for RS485 or CAN communication. The GND signal is internally connected to DSUB9 pin2, 5V Housekeeping Bias Return.

POWER AND CONTROL SIGNAL DESCRIPTIONS

5V Housekeeping Bias

Supply Bias for CAN and RS485 communication and is internally connected to DSUB9 pin1, 5V Housekeeping Bias.

Lan_Reset Button

Button to reset the Ethernet setting to STATIC with IP address 192.168.2.100

Lan Status Button

For future expansion.

Rack Communication Connector - DSUB9 Port on Default ISOCOMM Board

Below figure shows the DSUB9 signals and pin locations.

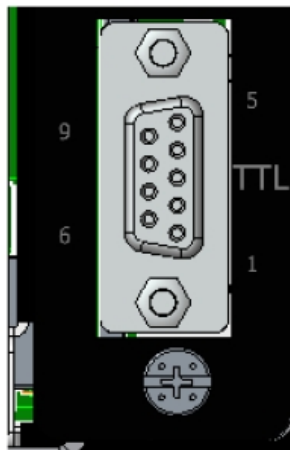

DSUB9 Signals

5V Housekeeping Bias	Pin 1
5V Housekeeping Bias Return	Pin 2
Spare (Not Connected)	Pin 3
Global Inhibit/Enable Logic "1"	Pin 4
Global Inhibit/Enable Logic "0"	Pin 5
ACOK - "Emitter"	Pin 6
ACOK+ "Collector"	Pin 7
Global DC OK - "Emitter"	Pin 8
Global DC OK + "Collector"	Pin 9

5V Housekeeping Bias - (pin 1)

5V supply for user housekeeping circuit. The maximum current is 1A and the output always presents whenever the iHP input is within operating input range. The regulation was +/-5%, the output was protected from short or over current. Output noise was 150mVp-p maximum measured with 150MHz bandwidth.

The signal is internally connected to the pin6 of RJ11, 5V Housekeeping Bias on pin4 and pin10.

5V Housekeeping Bias Return - (pin 2)

Ground for 5V Housekeeping Bias on DSUB9 pin2.

POWER AND CONTROL SIGNAL DESCRIPTIONS

Global Inhibit/Enable Logic "1" - (pin 4)

The Global Inhibit/Enable Logic "1" (pin 4) signal functions to turn-off or turn-on all modules simultaneously. This signal can be configured either Global Inhibit1 or Global Enable1 via ISOCOMM WebTool.

When this pin is configured as Inhibit1, a 5V input will activate inhibit function and will shutdown all modules. A ground connection or no connection will de-activate inhibit function and all modules will turn-on.

When this pin is configured as Enable1, a ground connection or no connection will de-activate enable function and will shutdown all modules. A 5V input will activate enable function and all modules will turn-on.

Global Inhibit/Enable Logic "0" - (pin 5)

The Global Inhibit/Enable Logic "0" (DSUB9 pin 5) signal functions to turn-off or turn-on all modules simultaneously. This signal can be configured either Global Inhibit0 or Global Enable0 via ISOCOMM WebTool.

When this pin is configured as Inhibit 0, a ground input will activate inhibit function and will shutdown all modules. A 5V input or no connection will de-activate inhibit function and all modules are enabled.

When this pin is configured as Enable 0, a 5V input or no connection will de-activate enable function and will shutdown all modules. A ground input will activate enable function and all modules are enabled.

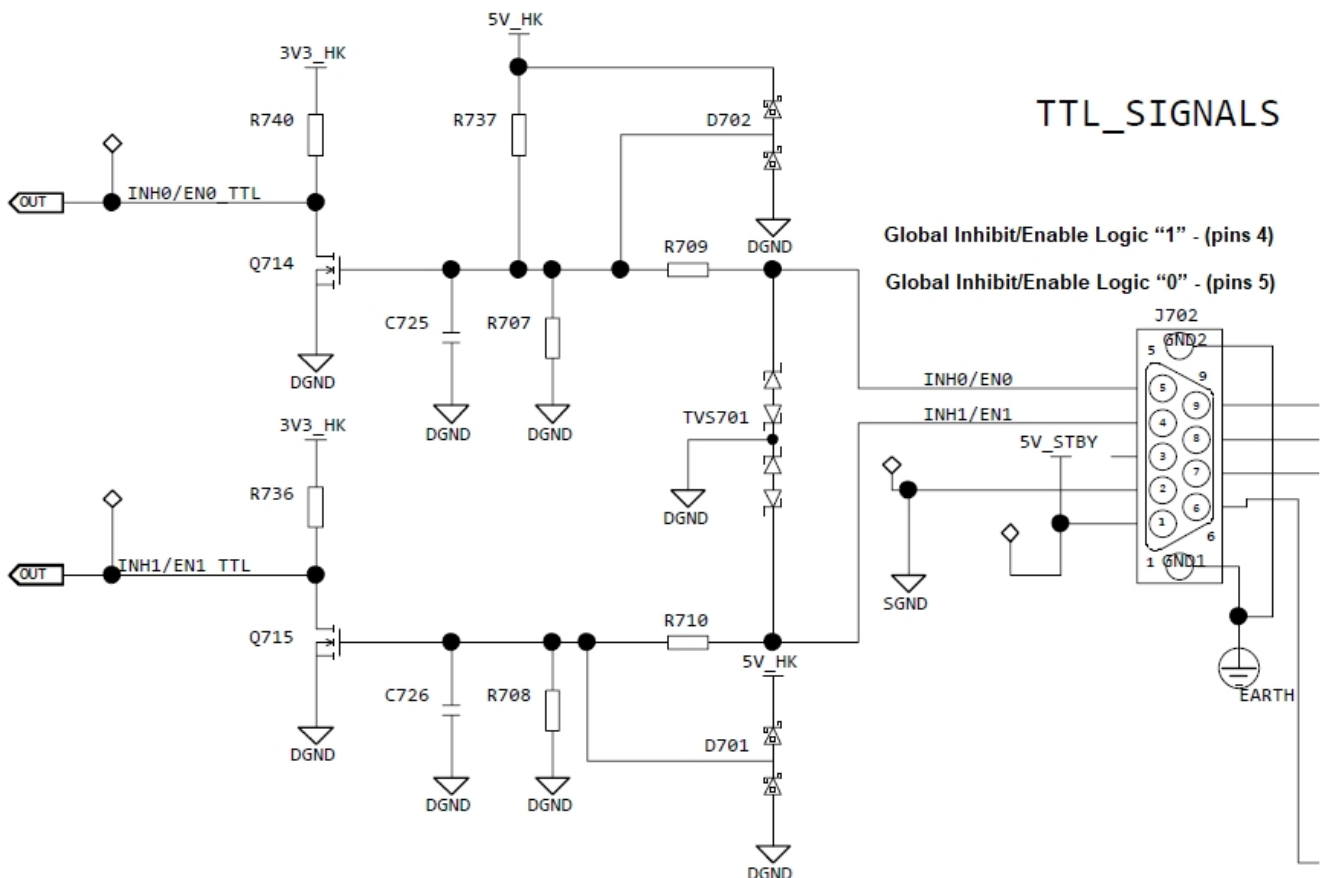

POWER AND CONTROL SIGNAL DESCRIPTIONS

Configuration	iHP Rack DSUB9		Module Status
	Input to Global Inhibit/Enable Logic "0"	Input to Global Inhibit/Enable Logic "1"	
INH0 & INH1 ¹	Shorted to GND	Floating	OFF
	Shorted to GND	5V	OFF
	Floating	Floating	ON
	Floating	5V	OFF
INH0 & EN1	Shorted to GND	Floating	OFF
	Shorted to GND	5V	OFF
	Floating	Floating	OFF
	Floating	5V	ON
EN0 & INH1	Shorted to GND	Floating	ON
	Shorted to GND	5V	OFF
	Floating	Floating	OFF
	Floating	5V	OFF
EN0 & EN1	Shorted to GND	Floating	OFF
	Shorted to GND	5V	ON
	Floating	Floating	OFF
	Floating	5V	OFF

Note 1 - Default setting

These two signals can be configured via ISOCOMM Webtool. Below is an example to show how to inhibit both signals.

Signals:

Power-Up Sequence :	<input type="text" value="Straight ON"/>
INH0/EN0 TTL Function :	<input type="text" value="Inhibit"/>
INH1/EN1 TTL Function :	<input type="text" value="Inhibit"/>
Disable on 5v_STBY Fault :	<input type="text" value="Disable"/>

POWER AND CONTROL SIGNAL DESCRIPTIONS

AC OK Signal "Power Fail" (Uncommitted Transistor) - (pins 6, 7)

This signal indicates that the input AC is within operational range of the unit. ACOK- "Emitter" (pin 6) and ACOK+ "Collector" (pin 7) signal functions as AC OK signal. These signals are connected to an uncommitted transistor. AC is OK when the transistor is On. AC is Not OK when the transistor is Off.

Max sink current is 50mA and the bias resistor will be chosen to limit current to a maximum of 50mA. Recommended supply voltage is 5V.

Recommended circuit configuration for AC_OK Signal:

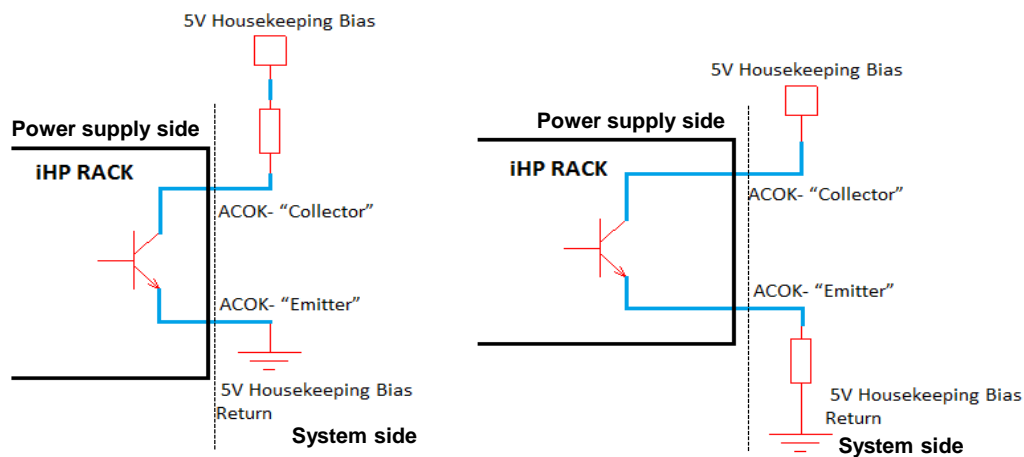

DC OK Signal "Output Fail" (Uncommitted Transistor) - (pins 8, 9)

This signal indicates that all modules are on and functioning properly. The signal will be de-asserted when at least one module turns off via fault or inhibited by the system. DCOK- "Emitter" (pin 8) and DCOK+ "Collector" (pin 9) signal functions as DC OK signal. These signals are connected to an uncommitted transistor. When all output of module is OK, the transistor is On. When all output of module is Not OK, the transistor is Off.

Max sink current is 50mA and the bias resistor will be chosen to limit current to a maximum of 50mA. Recommended supply voltage is 5V.

Recommended circuit configuration for DC_OK Signal:

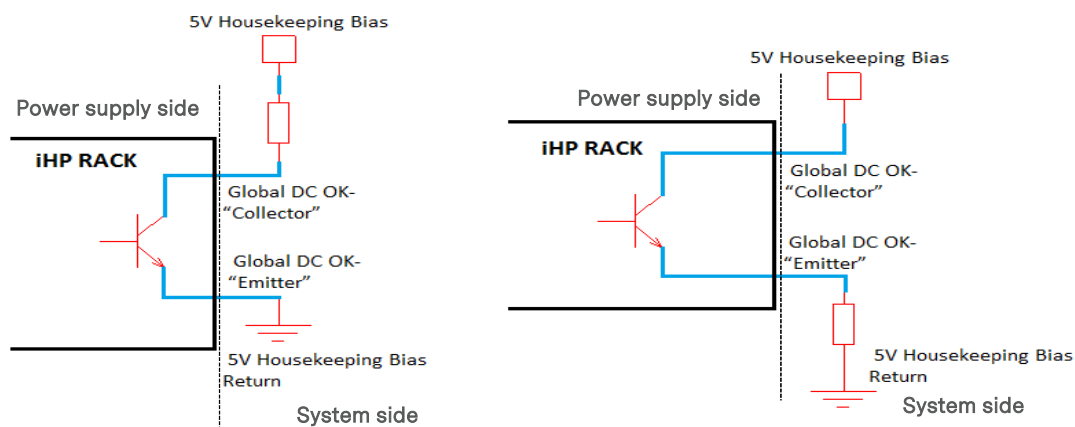

POWER AND CONTROL SIGNAL DESCRIPTIONS

Module Control Signal Connector - J1

The iHP series contain a 10 pins control signal header providing an analogue control interface.

Analog Voltage Programming - (pins 1,2,6)

0-10VEXT_VPROG (pin 1) and 0-5VEXT_VPROG (pin 2) are used to program the output voltage by applying external voltages between the pin and J1 pin8 (SYS_RTN). Analog voltage programming will work if the module configuration is in analog voltage source.

0-10VEXT_VPROG External Voltage	0-5VEXT_VPROG External Voltage	Corresponding Output Voltage
0.417V	0.208V	5% Nominal Output Voltage
0.833V	0.417V	10% Nominal Output Voltage
1.667V	0.833V	20% Nominal Output Voltage
2.5V	1.25V	30% Nominal Output Voltage
3.333V	1.667V	40% Nominal Output Voltage
4.167V	2.083V	50% Nominal Output Voltage
5V	2.5V	60% Nominal Output Voltage
5.833V	2.917V	70% Nominal Output Voltage
6.667V	3.333V	80% Nominal Output Voltage
7.5V	3.75V	90% Nominal Output Voltage
8.333V	4.167V	100% Nominal Output Voltage
9.167	4.583V	110% Nominal Output Voltage
10V	5V	120% Nominal Output Voltage

0-10VEXT_VPROG and 0-5VEXT_VPROG cannot be used simultaneously. If user use 0-10VEXT_VPROG, 0-5VEXT_VPROG will be floating. If user use 0-5VEXT_VPROG, 0-10VEXT_VPROG will be floating. When floating 0-10VEXT_VPROG or 0-5VEXT_VPROG or short those pins to SGND, the output voltage will be 5% of nominal output voltage.

Applying external 0-10Vdc between 0-10VEXT_VPROG (pin 1) and SYS_RTN (pin 8) on 250V module, the performance of the output voltage Vs external voltage shows as below.

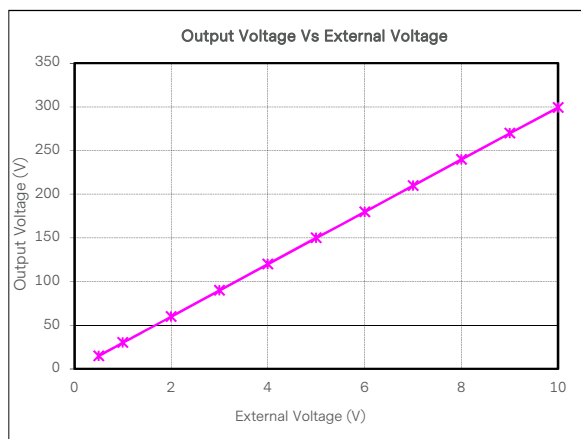

POWER AND CONTROL SIGNAL DESCRIPTIONS

Applying external 0-10Vdc between 0-10VEXT_VPROG (pin 1) and SYS_RTN (pin 8) on 80V, the performance of the output voltage Vs external voltage shows as below.

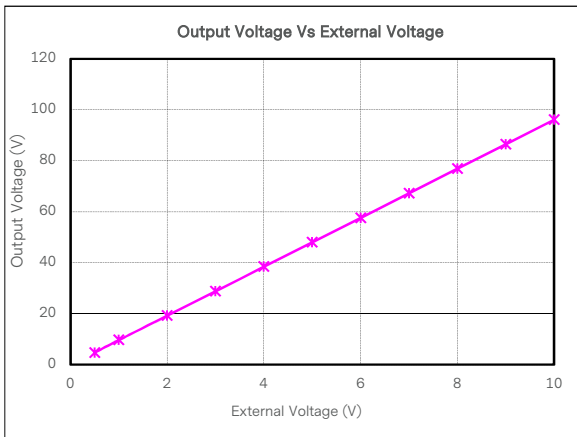

4-20mA_VPROG (pin 6) is used to program the output voltage by applying external source current between the pin and J1 pin8 (SYS_RTN).

4-20mA_VPROG	Corresponding Output Voltage
4mA	24% Nominal Output Voltage
5mA	30% Nominal Output Voltage
6.667mA	40% Nominal Output Voltage
8.333mA	50% Nominal Output Voltage
10mA	60% Nominal Output Voltage
11.667mA	70% Nominal Output Voltage
13.333mA	80% Nominal Output Voltage
15mA	90% Nominal Output Voltage
16.667mA	100% Nominal Output Voltage
18.333mA	110% Nominal Output Voltage
20mA	120% Nominal Output Voltage

POWER AND CONTROL SIGNAL DESCRIPTIONS

Analog Current Programming - (pins 3,4,5)

0-10VEXT_IPROG (pin 3) and 0-5VEXT_IPROG (pin 4) are used to program the output current by applying external voltages between the pin and J1 pin8 (SYS_RTN). Analog current programming will work if the module configuration is in analog current source.

0-10VEXT_IPROG and 0-5VEXT_IPROG cannot be used simultaneously. If user will use 0-10VEXT_IPROG, 0-5VEXT_IPROG will be floating. If user will use 0-5VEXT_IPROG, 0-10VEXT_IPROG will be floating.

0-10VEXT_IPROG External Voltage	0-5VEXT_IPROG External Voltage	Corresponding Output Current
0V	0V	0
0.5V	0.25V	5% Rated Output Current
1V	0.5V	10% Rated Output Current
2V	1V	20% Rated Output Current
3V	1.5V	30% Rated Output Current
4V	2V	40% Rated Output Current
5V	2.5V	50% Rated Output Current
6V	3V	60% Rated Output Current
7V	3.5V	70% Rated Output Current
8V	4V	80% Rated Output Current
9V	4.5V	90% Rated Output Current
10V	5V	100% Rated Output Current

Applying external 0-10Vdc between 0-10VEXT_IPROG (pin 3) and SYS_RTN (pin 8) on 250V module, the performance of the output current Vs external voltage shows as below.

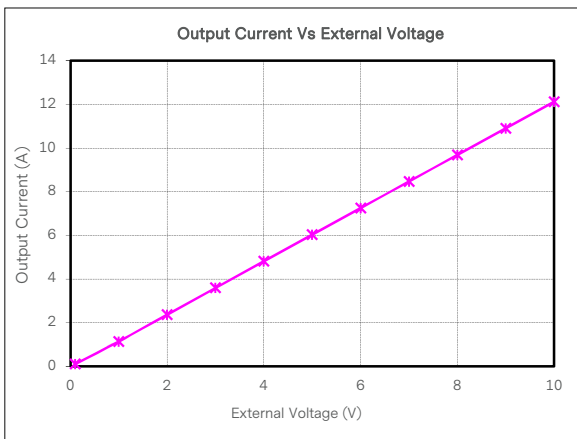

POWER AND CONTROL SIGNAL DESCRIPTIONS

Applying external 0-10Vdc between 0-10VEXT_IPROG (pin 3) and SYS_RTN (pin 8) on 80V module, the performance of the output current Vs external voltage shows as below.

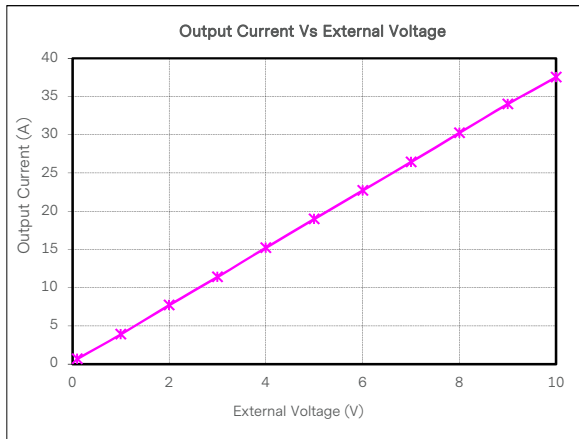

4-20mA_IPROG (pin 5) is used to program the output current by applying external source current between the pin and J1 pin8 (SYS_RTN).

4-20mA_IPROG	Corresponding Output Current
4mA	20% Rated Output Current
6mA	30% Rated Output Current
8mA	40% Rated Output Current
10mA	50% Rated Output Current
12mA	60% Rated Output Current
14mA	70% Rated Output Current
16mA	80% Rated Output Current
18mA	90% Rated Output Current
20mA	100% Rated Output Current

POWER AND CONTROL SIGNAL DESCRIPTIONS

Isolated Output Inhibit - (pin 7)

iHP Module provides an input signal to inhibit the output. SYS_M_INHIBIT functions as the inhibit signal of the module. This inhibit pin is internally connected to an optocoupler's LED side. An external pull up 1k ohms resistor is required. The pull up resistor is connected to a 5V supply. Maximum Pull up resistor voltage is 5V. Max sink current is 5mA.

Logic for this pin is configurable via PMBUS Register 0xB7h. There are two possible logics for this pin: optocoupler's LED On and optocoupler's LED Off.

The default pin configuration is:

Optocoupler's LED On = Output is Disable

Optocoupler's LED Off = Output is Enable

The recommended external circuit control of Inhibit pin is as below figure:

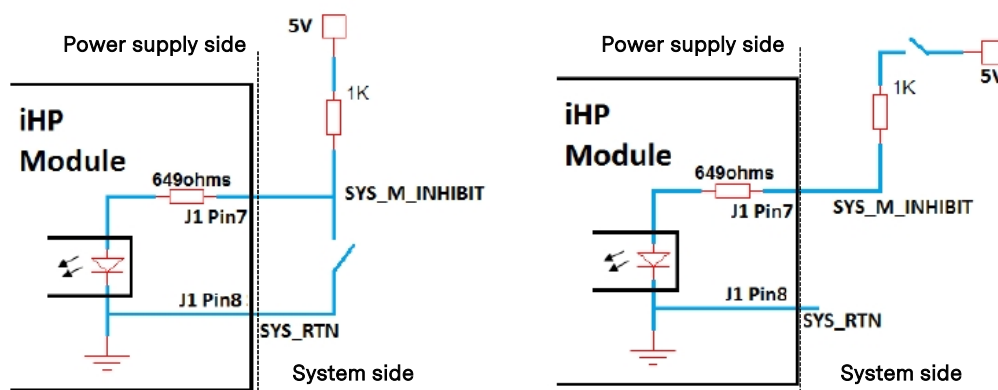

SYS_RTN - (pin 8)

SYS_RTN (J1 pin 8) is the common ground for J1 signals. It is isolated from Module Negative Output terminal.

POWER AND CONTROL SIGNAL DESCRIPTIONS

Isolated Output Enable - (pin 9)

iHP Module provides an input signal to enable the output. SYS_M_ENABLE functions as the enable signal of the module. This pin is internally connected to an optocoupler's LED side. An external pull up 1k ohms resistor is required. The pull up resistor is connected to a 5V supply. Maximum Pull up resistor voltage is 5V. Max sink current is 5mA.

Logic for this pin is configurable via PMBUS Register 0xB7h. There are two possible logics for this pin: optocoupler's LED On and optocoupler's LED Off.

The default pin configuration is:

Optocoupler's LED On = Output is Disable

Optocoupler's LED Off = Output is Enable

The recommended external circuit control of enable pin is as below figure:

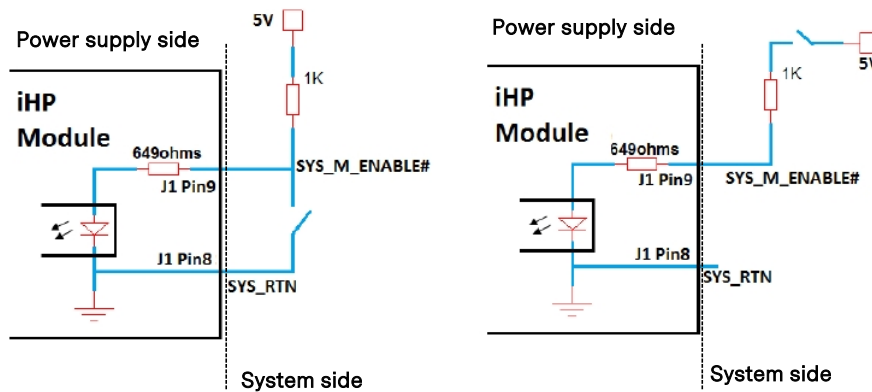

Isolated Fault Signal - (pin 10)

During fault condition, iHP Module can provide fault signal to the system side. SYS_M_FAULT# function as the fault signal of the module. This signal is internally connected to an open collector output. A recommended external pull up of 2k ohms resistor is required. The pull up resistor is connected to a 5V supply.

Maximum pin voltage is 5V with max sink current of 5mA.

Logic for this pin is configurable via PMBUS Register 0xB7h.

The default configuration is:

SYS_M_FAULT# logic Low = Module is at Fault.

SYS_M_FAULT# logic High = Module is at normal operating condition.

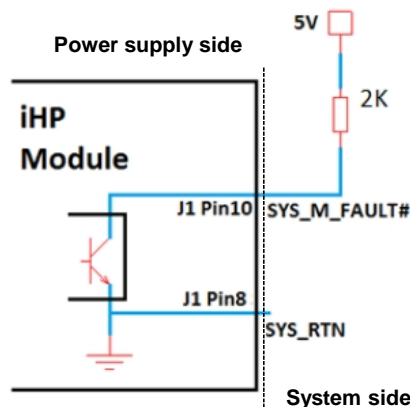

POWER AND CONTROL SIGNAL DESCRIPTIONS

Module Control Signal Connector - J2

The iHP series contains a 12 pins analog connector J2 non-isolated signal. The signal's circuitry is internally connected to the module's output negative terminal. The module's J2 signals are isolated from module's J1 signals.

V_SNS+ and V_SNS- (pins 1, 8)

The distance of the load and the module can create voltage drop on the wires. To compensate for the voltage drops on the wire remote sense is employed. The module has a + return ("V_SNS+" J2 pin 1) and a - return ("V_SNS-" J2 pin 8) remote sense to compensate for ground drops and line drops respectively. Remote sense will be able to regulate out a maximum of 200mV drop on each sense line. The module must operate within specification over the full range of the voltage drops from the module's output terminal to the remote senses point.

It is recommended for user to connect the remote sense either on the load side or to the output terminals of the modules. The connection of the remote sense signal determines the point at which the voltage will regulate. Remote sense is required to meet the regulation specification of the module.

Remote sense is necessary during voltage source configuration. If the V_SNS+ is shorted to the module's negative terminal, the rising output shall trigger OVP and the module will latch off.

It is recommended to use twisted and equal length wires for V_SNS+ and V_SNS- for noise immunity.

For parallel module output operation,

All Module V_SNS+ should be star connected

All Module V_SNS- should be star connected

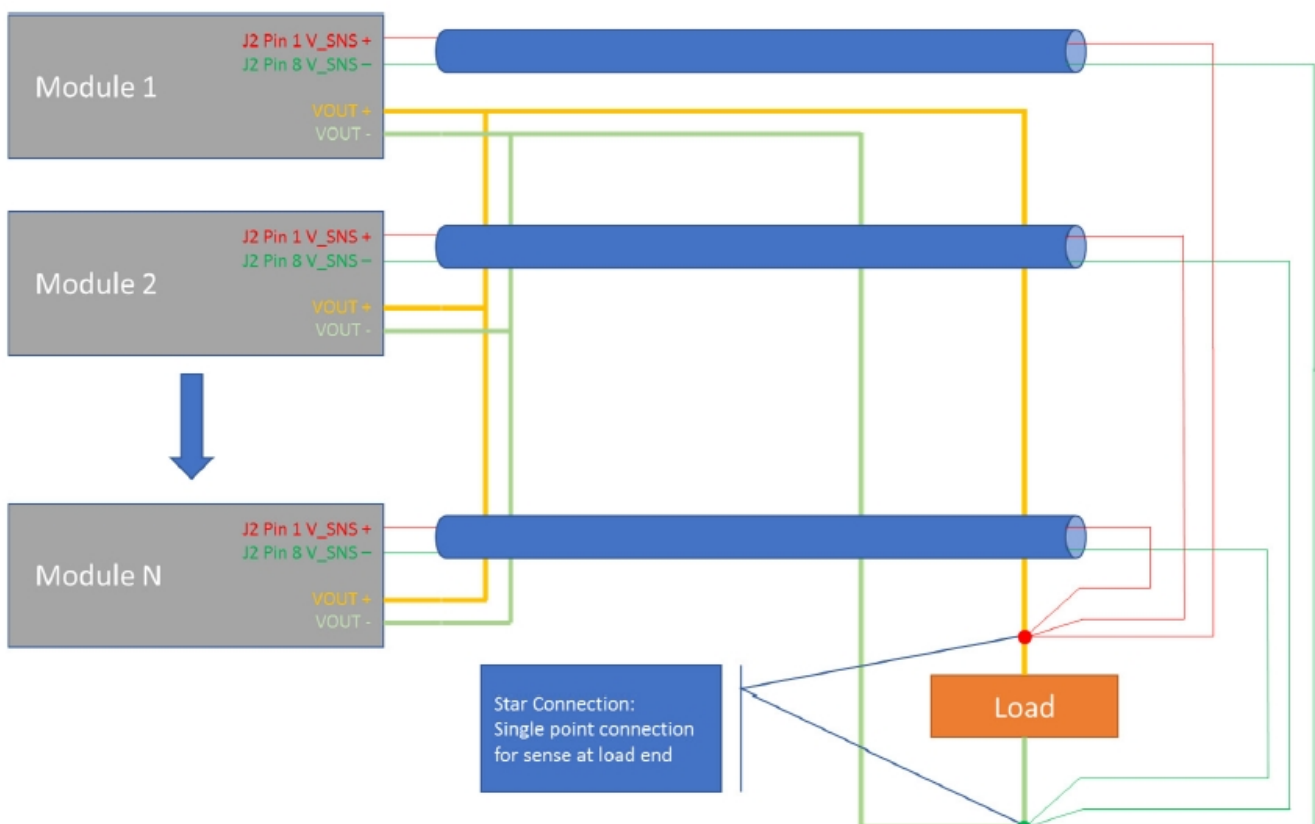

POWER AND CONTROL SIGNAL DESCRIPTIONS

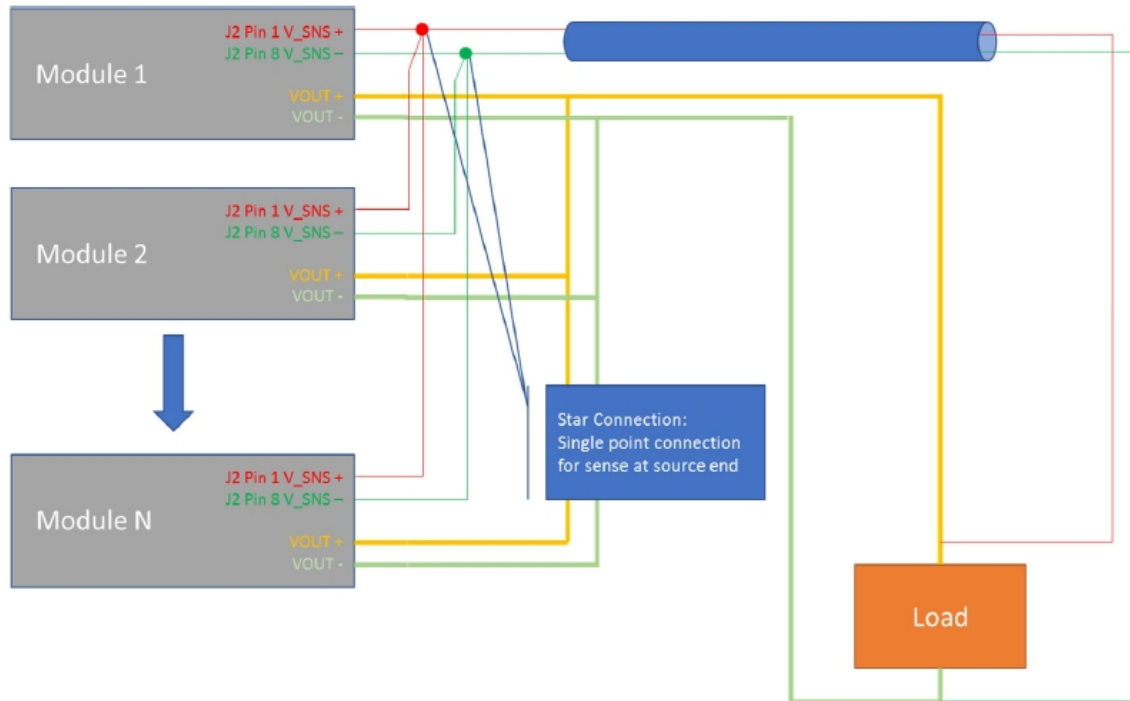

D_RTN - (pins 2, 4, 7)

D_RTN (J2 pin 2 and pin 7) is used for twisted pair cabling of IMON and VMON signal to reduce noise pick-up. It is internally connected to module's negative output and D_RTN is isolated from module's J1 SYS_TRN.

D_RTN (J2 pin 2) is used for twisted pair cabling with IMON.

D_RTN (J2 pin 7) is used for twisted pair cabling with VMON.

D_RTN (J2 pin 4) is used for ground reference of ISHARE.

CURRENT SHARING Signal - (pin 10)

ISHARE (J2 pin 10) signal is used for active current sharing. Active current sharing is required when modules are connected in parallel. It is recommended to star-connect Module's ISHARE signal and D_RTN (J2 pin 4) for reduce the introduction of DC offset and noise to the signals.

Load (A)	ISHARE Duty (%)	
	Min	Max
50% of Rated Output Current	23	27
100% of Rated Output Current	48	52

POWER AND CONTROL SIGNAL DESCRIPTIONS

EXTERNAL CURRENT SENSE - (pins 3, 9)

External Shunt resistor can be connected to the iHP Module. The current sense will be transferred from iHP module internal shunt to external shunt. iHP Module's "EXT_ISENSE+" (J2 pin 3) and "EXT_ISENSE-" (J2 pin 9) signals are used for external current sense application.

User need to change the module configuration per ISOCOMM command D3h to enable External Current Sense operation.

Using external current sense, all output current information used by the iHP Module will be taken from the differential voltage across the external shunt. This includes output reporting, current protection, and constant current operation.

Connection of the external shunt is on the negative output busbar of the iHP Module ONLY.

The "EXT_ISENSE-" is connected to the external shunt's negative output busbar side

The "EXT_ISENSE+" is connected to the external shunt's load side.

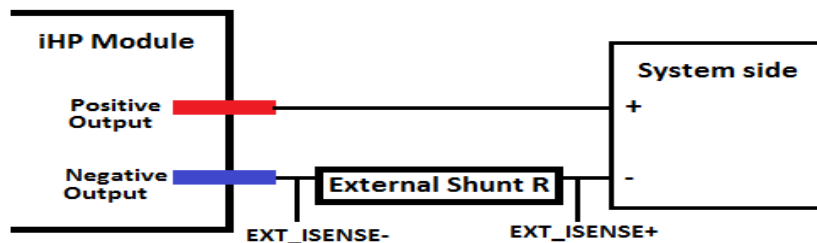

Please see below table for the recommended shunt resistor per iHP Module.

iHP Module	Current Rating (A)	Voltage Drop (mV)	Tolerance Max (%)	TCR max (ppm/degC)
12V	200	10	+/- 5	25
24V	200	12	+/- 5	25
32V	90	15.03	+/- 5	25
48V	62.5	7.8125	+/- 5	25
80V	37.5	9.375	+/- 5	25
125V	24	12	+/- 5	25
200V	15	12	+/- 5	25
250V	12	12	+/- 5	25

User can connected External shunt aside from the recommended values.

POWER AND CONTROL SIGNAL DESCRIPTIONS

CURRENT MONITOR (IMON) - (pin 5)

IMON (J2 pin 5) is an output signal. This functions as the current monitor signal of the module. It reports the sensed output current with a scaled value (0-10V). D_RTN (J2 pin 2) is used for twisted pair cabling with IMON.

IMON	Output Current
0V	0% of Rated Output Current
0.5V	5% of Rated Output Current
1V	10% of Rated Output Current
2V	20% of Rated Output Current
3V	30% of Rated Output Current
4V	40% of Rated Output Current
5V	50% of Rated Output Current
6V	60% of Rated Output Current
7V	70% of Rated Output Current
8V	80% of Rated Output Current
9V	90% of Rated Output Current
10V	100% of Rated Output Current

IMON Accuracy

% Output Current	IMON	Error Limit
1%	0.1	0.2V
10%	1	0.2V
20%	2	0.2V
30%	3	0.2V
40%	4	0.2V
50%	5	0.2V
60%	6	0.2V
70%	7	0.2V
80%	8	0.2V
90%	9	0.2V
100%	10	0.2V

POWER AND CONTROL SIGNAL DESCRIPTIONS

VOLTAGE MONITOR (VMON) - (pin 11)

VMON (J2 pin 11) is an output signal. This functions as the voltage monitor signal of the module. It reports the sense output voltage in scaled value (0-10V). D_RTN (J2 pin 7) is used for twisted pair cabling with VMON.

VMON	Output Voltage
0.417V	5% Nominal Output Voltage
0.833V	10% Nominal Output Voltage
1.667V	20% Nominal Output Voltage
2.5V	30% Nominal Output Voltage
3.333V	40% Nominal Output Voltage
4.167V	50% Nominal Output Voltage
5V	60% Nominal Output Voltage
5.833V	70% Nominal Output Voltage
6.667V	80% Nominal Output Voltage
7.5V	90% Nominal Output Voltage
8.333V	100% Nominal Output Voltage
9.167V	110% Nominal Output Voltage
10V	120% Nominal Output Voltage

VMON Accuracy

% Output Voltage	VMON	Error Limit
5%	0.417V	0.2A
10%	0.833V	0.2A
20%	1.667V	0.2A
30%	2.5V	0.2A
40%	3.333V	0.2A
50%	4.167V	0.2A
60%	5V	0.2A
70%	5.833V	0.2A
80%	6.667V	0.2A
90%	7.5V	0.2A
100%	8.333V	0.2A
110%	9.167V	0.2A
120%	10V	0.2A

APPLICATION NOTES

Current Sharing

The iHP series' main output is equipped with current sharing capability. This will allow up to 8 modules to be connected in parallel in 1 rack and up to 6 racks to be connected in parallel for higher power application.

The current sharing accuracy is typically $\pm 10\%$ limits of nominal full load current.

Output Blocking Diode and Antiparallel Diode Recommendation

The iHP modules can be used in a redundant parallel system by connecting the outputs together via OR-ing diodes. For good regulation the remote sense connections must be made after the OR-ing diode at the same point on the busbar or load. The remote sense leads should be the same length for each power supply and a twisted pair should be used for best noise immunity. The current sharing accuracy is typically $\pm 10\%$ limits of nominal full load current.

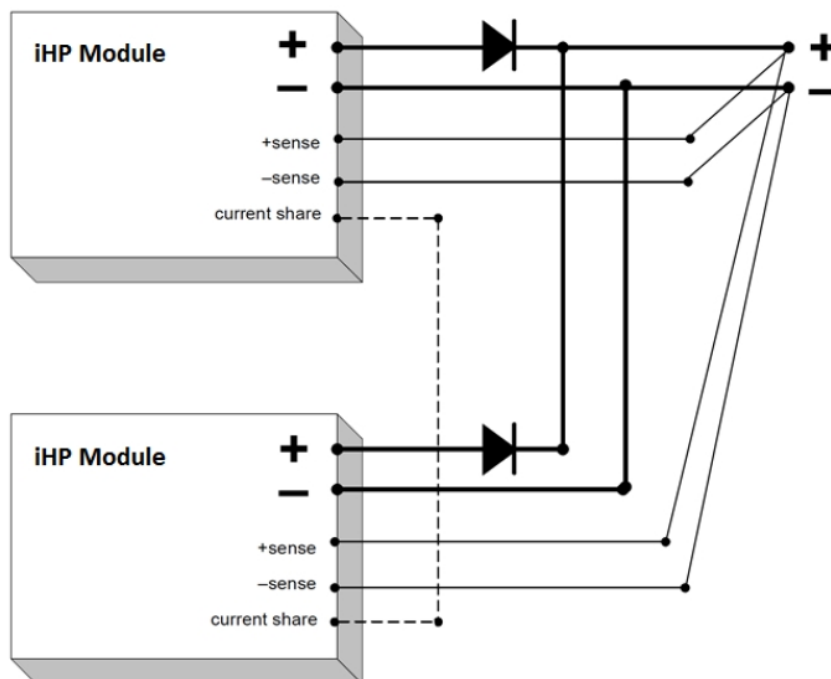

An antiparallel diode should be connected across each module's terminal to prevent sinking of current into one module when it is OFF while the others are ON. The diode should be capable of carrying the maximum current and the forward voltage (V_f) drop should be lower than what is in the table below.

APPLICATION NOTES

Module	Min Voltage Rating	Min Current Rating	Max Vf	Recommend device
12V	45V	300A	0.9V @ 160A (Tj = 125degC)	IXYS: DSS 2x160-0045A (45V 2x160A)
24V	45V	200A	0.9V @ 160A (Tj = 125degC)	IXYS: DSS 2x160-0045A (45V 2x160A)
32V	100V	120A	0.7V @ 80A (Tj = 125degC)	STMicroelectronics: STPS160H100TV (100V 2x80A)
48V	100V	120A	0.7V @ 80A (Tj = 125degC)	STMicroelectronics: STPS160H100TV (100V 2x80A)
80V	150V	80A	1.5V @ 50A (Tj = 125degC)	STMicroelectronics: STTH10002TV1 (200V 2x50A)
125V	200V	50A	1.5V @ 50A (Tj = 125degC)	STMicroelectronics: STTH10002TV1 (200V 2x50A)
200V	400V	30A	1.5V @ 60A (Tj = 125degC)	STMicroelectronics: STTH120R04TV1 (400V 2x60A)
250V	400V	30A	1.5V @ 60A (Tj = 125degC)	STMicroelectronics: STTH120R04TV1 (400V 2x60A)

For series connection, the remote sense for each module should be connected to its output busbar instead of the output load.

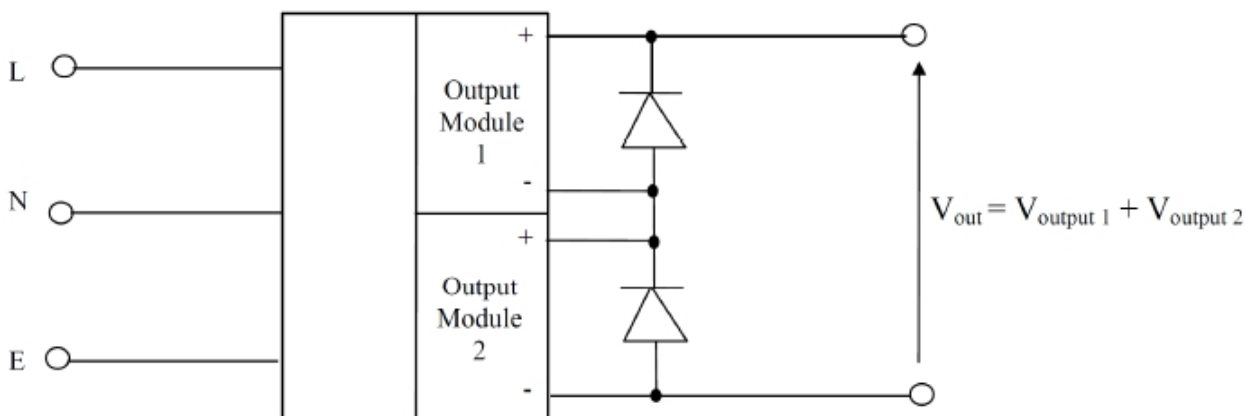

APPLICATION NOTES

Output Ripple and Noise Measurement

The setup outlined in the diagram below has been used for output voltage ripple and noise measurements on the iHP series power supply. When measuring output ripple and noise, a scope jack in parallel with a $0.1\mu\text{F}$ ceramic chip capacitor, and a $10\mu\text{F}$ tantalum capacitor will be used. Oscilloscope can be set to 20MHz bandwidth for this measurement.

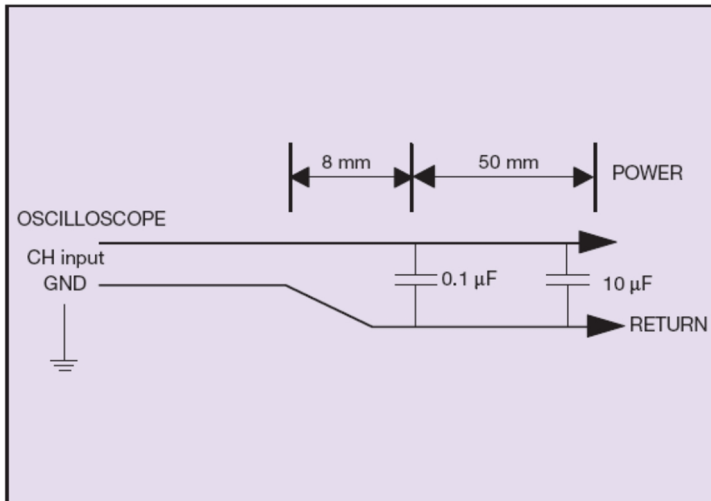

RECORD OF REVISION AND CHANGES

Issue	Date	Description	Originators
1.0	08.09.2017	First Issue	A. Zhang/K. Wang
1.1	12.27.2018	Update the order information	K. Wang
1.2	08.30.2019	Update the THD data to 100% load	K. Wang
1.3	07.01.2020	Update iHP24C and 12 kW modules	K. Ma/V. Guo
1.4	11.19.2020	Update efficiency information	K. Wang
1.5	02.18.2021	Add Vprog and Iprog curve on 250V and 80V model	K. Ma
1.6	12.02.2021	1. Add UKCA Mark 2. Add PMBus logo in page 1 3. Update the ripple spec for 200V module	K. Wang
1.7	02.18.2021	1. Add load capacitor range 2. Add DLC information	K. Ma K. Wang
1.8	04.20.2022	Add Operating Half-sine Shock	V. Guo
1.9	10.19.2022	Add note and example for DSUB9 connector	K. Ma
2.0	10.24.2023	iHP24L3A & iHP24H3A can support SEMI-F47 compliance for full load without derating	K. Wang
2.1	11.15.2023	Update the "CONF CODE" for Special configuration	K. Wang
2.2	01.12.2024	1. The "C" suffix is added after the case code on item 1 under A: Accessory Options. Example: iHP24H3AC-S1(5)-AS 2. Update Mechanical Drawing for 3000W Module	K. Wang
2.3	03.15.2024	Remove Module/Voltage code 5 from page 2	K. Wang
2.4	08.25.2025	Add mounting information for iHP12	K. Wang
2.5	11.06.2025	Add iHP15/30 related info and optional ISOCOMM board with EtherCAT.	A. Zhang



For international contact information,
visit advancedenergy.com.

powersales@aei.com (Sales Support)
productsupport.ep@aei.com (Technical Support)
+1 888 412 7832

ABOUT ADVANCED ENERGY

Advanced Energy (AE) has devoted more than three decades to perfecting power for its global customers. AE designs and manufactures highly engineered, precision power conversion, measurement and control solutions for mission-critical applications and processes.

Our products enable customer innovation in complex applications for a wide range of industries including semiconductor equipment, industrial, manufacturing, telecommunications, data center computing, and medical. With deep applications know-how and responsive service and support across the globe, we build collaborative partnerships to meet rapid technological developments, propel growth for our customers, and innovate the future of power.

PRECISION | POWER | PERFORMANCE

Specifications are subject to change without notice. Not responsible for errors or omissions. ©2020 Advanced Energy Industries, Inc. All rights reserved. Advanced Energy®, and AE® are U.S. trademarks of Advanced Energy Industries, Inc.